



Inspiring sliding solutions on furniture

Product overview
and details

Inspiring sliding solutions on furniture

Hawa Combino

Hawa Combino L

Hawa Clipo

Hawa Concepta

Hawa Folding Concepta

4 The world of sliding

- 4 Areas of application and forms
- 6 Sliding solutions in buildings

8 Solutions for wood applications

- 10 **Hawa Combino**
 - 12 Hawa Combino 20 H IS
 - 16 Hawa Combino 20 H MS
 - 20 Hawa Combino 20 H FS
 - 25 Hawa Combino 35 H IS
 - 29 Hawa Combino 35 H MS
 - 33 Hawa Combino 35 H FS
 - 38 Hawa Combino 50 H MS with soft close
 - 42 Hawa Combino 50 H MS without soft close
 - 45 Hawa Combino 50 H FS with soft close
 - 50 Hawa Combino 50 H FS without soft close
 - 54 Hawa Combino 65 H IS ol
 - 58 Hawa Combino 65 H MS ol
 - 61 Hawa Combino 65 H FS ol
 - 65 Hawa Combino 65 H FS ul
 - 69 Hawa Combino 80 H FS ol
 - 73 Hawa Combino 80 H FS ul
- 78 **Hawa Combino L**
 - 80 Hawa Combino L 40 H FS
 - 84 Hawa Combino L 40 H FS Synchro
- 90 **Hawa Clipo**
 - 92 Hawa Clipo 15 H IS
 - 96 Hawa Clipo 15 H MS
 - 100 Hawa Clipo 15 H FS
 - 103 Hawa Clipo 16 H IS
 - 107 Hawa Clipo 16 H MS
 - 112 Hawa Clipo 16 H FS
 - 116 Hawa Clipo 16 H FS 4-point guidance
 - 120 Hawa Clipo 16 HM IS
 - 125 Hawa Clipo 26 H IS
 - 131 Hawa Clipo 26 H MS
 - 136 Hawa Clipo 36 H IS
 - 142 Hawa Clipo 36 H MS
 - 147 Hawa Clipo 36 HM IS
- 154 **Hawa Concepta**
 - 156 Hawa Concepta 25
 - 161 Hawa Concepta 30
 - 166 Hawa Concepta 40
 - 171 Hawa Concepta 50
- 176 **Hawa Folding Concepta**
 - 178 Hawa Folding Concepta 25

Protection of trademarks/Copyright

Hawa is a trademark registered in the name of Hawa Sliding Solutions AG. The names Junior, Concepta, Clipo and Frontino are product family names either registered in the name of Hawa Sliding Solutions AG, or to which Hawa Sliding Solutions AG claims exclusive rights of use in connection with its products and services. The contents of this publication, including all photographs and graphics are protected by copyright, and may not be copied, modified or otherwise used without the explicit consent of Hawa Sliding Solutions AG.

General Terms and Conditions

Conditions of sale, delivery and payment are subject to the General Terms and Conditions of Hawa Sliding Solutions AG, which are available at www.hawa.com.

196 Solutions for glass applications

198 Hawa Clipo

- 200 Hawa Clipo 16 GK IS
- 203 Hawa Clipo 16 GS IS
- 206 Hawa Clipo 16 GPK IS
- 209 Hawa Clipo 16 GPPK IS
- 212 Hawa Clipo 26 GR IS
- 216 Hawa Clipo 36 GPK IS
- 221 Hawa Clipo 36 GPPK IS
- 226 Hawa Clipo 36 GPPK IS Fixed glass
- 230 Hawa Clipo 36 G IS

236 Accessories

- 236 Straightening fitting
- 238 Handle profiles
- 239 Hawa Combino Individual components
- 240 Hawa Combino Soft close order overview
- 242 Hawa Clipo Locking systems

246 Product overview on furniture

- 249 Glass recommendations
- 250 Technical information
- 251 Contacts
- 252 Product overview
On buildings, in buildings, on furniture

Areas of application and forms





Creative and functional added value on buildings, in buildings and on furniture

Access for light, air and people must be created and implemented in every building, room and furniture item. Sliding solutions are the superior approach for aesthetic, functional and cost-effective design.



On buildings

Architecture comes to life.

- Sliding shutters
- Folding sliding shutters



In buildings

Rooms become flexible and of high quality.

- Sliding doors
- Sliding walls
- Folding sliding walls
- Showers



On furniture

The right application for every design idea.

- Sliding doors
- Pivot and folding/sliding doors
- Folding sliding doors

Specific types of sliding solve every task for every environment.

Parallel sliding alone isn't enough to cover every need. Therefore, we have developed extended solutions such as folding, pivoting, slide-in and stacking.



Sliding



Folding sliding



Pivot sliding



Pivot folding



Sliding and stacking



Design is what you see. And what you don't see.

Sliding solutions for application on furniture

Functionality and aesthetics are decisive quality criteria for evaluating a furniture item. Sliding technology increases both.

Sliding solutions on furniture create new open spaces which ensure that areas can be designed and furnished in a spacious and flexible way. People want as much free space and openness as possible – in both the private and the corporate sphere. New room concepts are made possible by means of sliding solutions.

Furniture design combines aesthetics and practical value.

- Wide range of sliding forms (pivot, folding, folding sliding, pull-outs)
- Simple operation and assembly
- High material and design quality of the fittings

A general overview of all solutions for sliding on furniture is provided in the product overview starting on page 52.



Fronts with substance

Sliding doors provide a wide variety of access options for cabinet walls.



Saving space

Every square centimeter is valuable, particularly in small rooms. Sliding saves space.



Using ergonomics

For commercially or industrially used furniture, the ergonomics of sliding solutions pays for itself over the years.



Beauty impresses

A beautiful item of furniture can give you years of pleasure. Sliding technology is often the key to this.



Re-interpretation of traditional material

Solutions for wood applications

Man has been relying on wood ever since he started to build furniture. And at a time when naturalness and sustainability are values which are increasingly in demand, there is no way around the most popular material, and rightly so. Hawa Sliding Solutions supports this meaningful trend with innovative, easy to install sliding solutions for every design, functional and aesthetic requirement.



Wooden sliding doors

Suitable wooden sliding doors from Hawa Sliding Solutions are equally as diverse as the requirements, applications, designs and dimensions of the furniture. They run inside and in front of the cabinet or a combination of both, impress with a silent running system and integrated soft closing technology, are easy to install and adjust, and can be moved with a minimal amount of force. This is how they provide functional, aesthetic solutions for all facets of professional and private life.



Discover our fitting solutions for wooden sliding doors from **Page 10**

Wooden pivot and folding/sliding doors

Pivot and folding/sliding doors are the magicians among furniture doors. They make flush-fitting wooden cabinet fronts disappear or reappear with a single movement, can be parked away in barely visible niches, and run into the cushioned end position independently. This opens up creative application options for doors and gateways: from the pop-up home office to the utility room in the bathroom and the kitchen in the living room.



Discover our fitting solutions for wooden pivot and folding/sliding doors from **Page 154**



Hawa Combino for wooden sliding doors

As easy to install as it is to slide






What is the meaning of comfort with a sliding door fitting such as the Hawa Combino? For the user, it means that the amount of force required to move the doors is hardly noticeable. And that the furniture doors will run extremely quietly and stop gently thanks to the guide with zero clearance, an excellent running system and soft closing technology that is completely integrated in the system. It is also convenient to be able to rely on maximum functional reliability during a long service life. For cabinet makers and furniture constructors it is a pleasure to work with the Hawa Combino. No processing is needed on the cabinet, the door is fitted without tools, continuous door adjustment is possible on the finished furniture item, the handles blend perfectly into the cabinet design and even extremely creative designs can be efficiently implemented.







Area of application

Compact to room-high cabinets in all sizes for offices, living areas and business premises.

System advantages

-  **Flexibility** **16 different cabinet designs** Inslide, Forslide and Mixslide with one technology for **maximum design freedom**
-  **Productivity** **Tool-less door mounting** thanks to intelligent click connections
High degree of pre-assembly for **quick, easy installation**
Intuitive, **continuous adjustment** of all components
-  **Comfort** **Smooth, silent running** with Hawa Comfort roller
Sophisticated soft closing system and innovative arrangement of the components for **very easy operation**
-  **Aesthetics** **Invisible technology** makes high-quality cabinet design possible
-  **Security** Innovative, intelligent technology guarantees **a high degree of functional**

Technical specifications

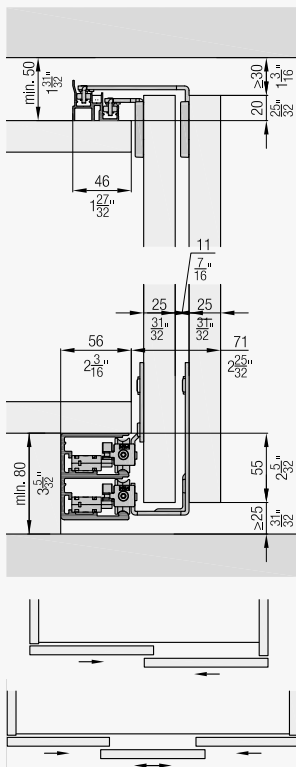
-  max. 20/35/40/
50/65/80 kg
-  max. 2800 mm
-  max. 1600 mm
-  19–40 mm

Good to know (accessories)

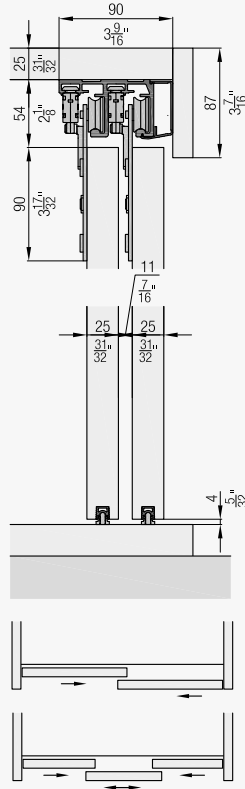
- Straightening fitting for doors
- Handle profiles
- Soft close

Installation examples

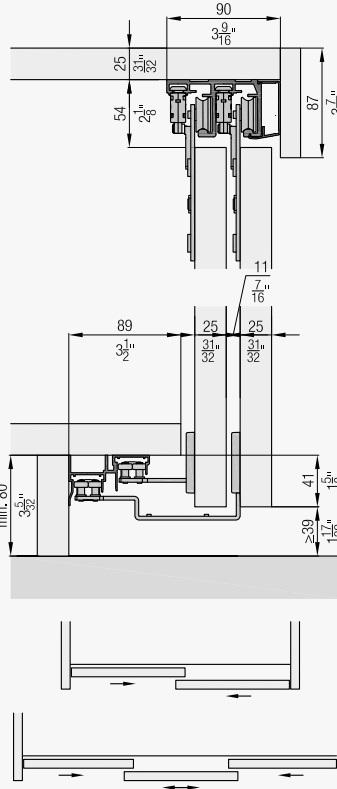
Hawa Combino 50 H FS with soft close



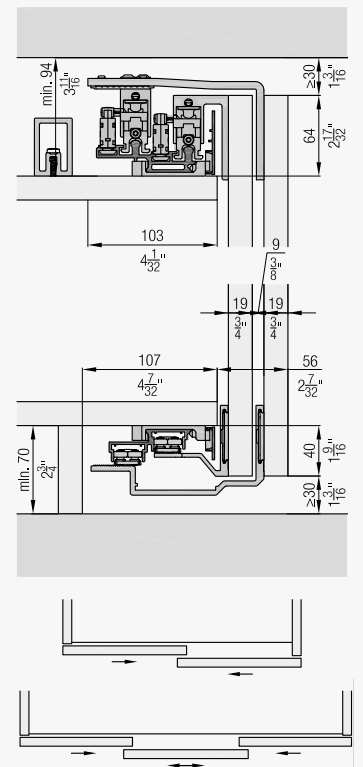
Hawa Combino 65 H IS



Hawa Combino 65 H MS



Hawa Combino 80 H FS ol



Product range

- Hawa Combino 20 H FS
- Hawa Combino 35 H FS
- Hawa Combino 50 H FS with soft close
- Hawa Combino 65 H FS ul
- Hawa Combino 80 H FS ul



- Hawa Combino 20 H IS
- Hawa Combino 35 H IS
- Hawa Combino 65 H IS

- Hawa Combino 20 H MS
- Hawa Combino 35 H MS
- Hawa Combino 65 H MS




- Hawa Combino 65 H FS ol
- Hawa Combino 80 H FS ol

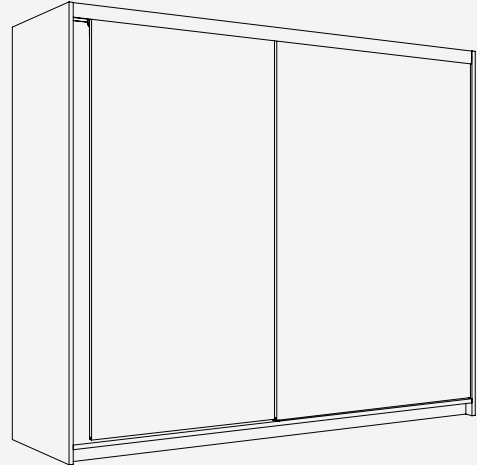
Fitting for 2 top-running wooden doors up to 20 kg (44 lbs.), with screwed on running track and wooden or aluminum clip panel. Soft close optional. Design Inside.

Product highlights

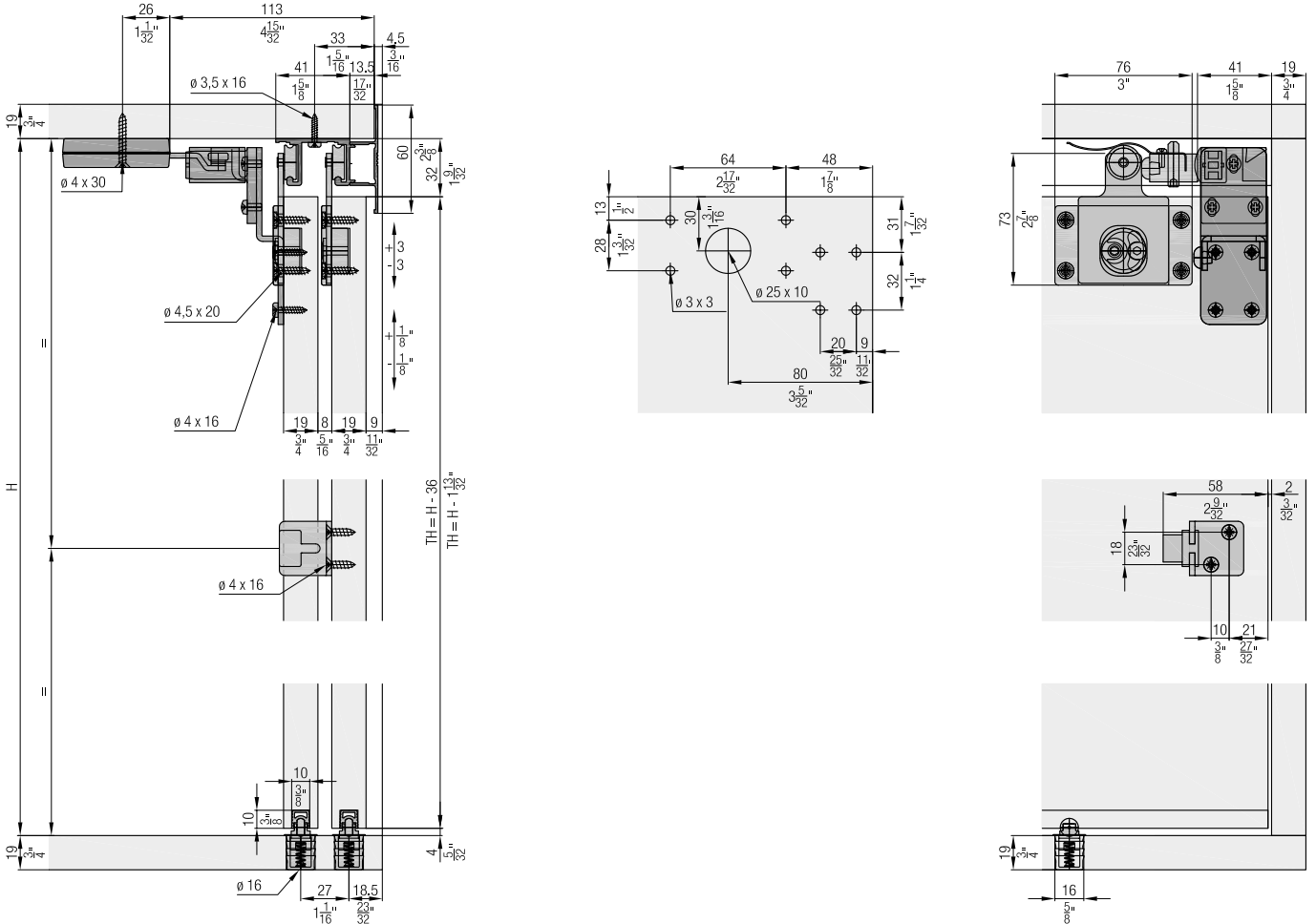
-  **Comfort** High operating convenience thanks to proven running system and optional soft closing technology
-  **Productivity** No cabinet processing, high degree of pre-assembly and access from the front for easy, quick installation

Technical specifications

-  Max. 20 kg (44 lbs.)
-  Max. 2200 mm (7'2 5/8")
-  Max. 1200 mm (3'11 1/4")
-  19 mm (3/4")







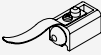


Installation examples



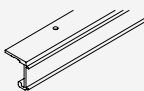
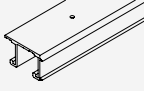
Set for 2 wooden doors

	No.
Hawa Combino 20 H IS, for 2 doors	056.3180.071

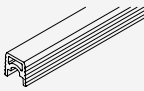
Set consisting of:

		056.3180.071	No.
	Running gear, steel, zinc-plated	4	056.3176.171
	Running gear housing, plastic, anthracite	4	056.3175.001
	Bottom guide, plastic, gray	2	055.3081.071
	Stopper, plastic, gray	2	056.3189.071
	Stopper, with retention spring, plastic, gray	2	056.3189.072
	Door follower, with 2 doors, steel, zinc-plated	1	055.3124.071
	Countersunk head screw, 4.5x20 mm, steel, zinc-plated	16	600.0000.167


Running tracks

		mm (inch)	No.
	Single running track, aluminum, pre-drilled	2500 (8'2 7/16")	056.3011.250
		3500 (11'5 25/32")	056.3011.350
		6000 (19'8 7/32")	056.3011.600
	Double running track, aluminum, pre-drilled	2500 (8'2 7/16")	056.3010.250
		3500 (11'5 25/32")	056.3010.350
		6000 (19'8 7/32")	056.3010.600

Guide tracks

		mm (inch)	No.
	Guide track, plastic, gray, for glue fixing	2500 (8'2 7/16")	055.3171.250
		3500 (11'5 25/32")	055.3171.350
		6000 (19'8 7/32")	055.3171.600

Panels

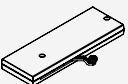
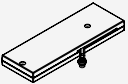




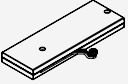
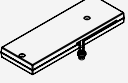
		mm (inch)	No.
	Clip-on panel, aluminum, anodized	2500 (8'2 7/16")	056.3174.250
		3500 (11'5 25/32")	056.3174.350
		6000 (19'8 7/32")	056.3174.600

Soft close

Adapter soft close must be ordered separately

	No.
Soft close, up to 18 kg (40 lbs.), with wide follower, 2 pieces	055.3091.071
Soft close, 18–40 kg (40–88 lbs.), with wide follower, 2 pieces	055.3091.073






Set consisting of:

	055.3091.071	055.3091.073	No.
 Soft close, left, up to 18 kg (40 lbs.)	1		055.3090.071
 Soft close, right, up to 18 kg (40 lbs.)	1		055.3090.072
 Follower, for soft close, right, plastic, gray	1	1	055.3040.071
 Follower, for soft close, left, plastic, gray	1	1	055.3040.072
 Fillister head screw, 4x16 mm, steel, zinc-plated	6	6	600.0000.166
 Countersunk head screw, 4x30 mm, steel, zinc-plated	4	4	600.0000.439
 Soft close, left, 18–40 kg (40–88 lbs.)			1 055.3090.073
 Soft close, right, 18–40 kg (40–88 lbs.)			1 055.3090.074



Adapter soft close for No. 055.3091.071 and 055.3091.073

	No.
Adapter set, for soft close	055.3043.073

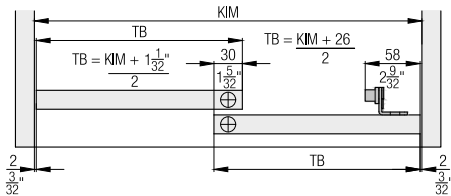
Set consisting of:

	055.3043.073	No.
 Adapter, for soft close, exterior door, steel, zinc-plated	1	055.0133.101
 Adapter, for soft close, interior door, steel, zinc-plated	1	055.0128.101
 Rounded head screw, M4x8 mm, steel, zinc-plated	6	759.0408.108
 Fillister head screw, 4x16 mm, steel, zinc-plated	8	600.0000.166
 Rubber buffer, plastic, grey	1	025.0107.001

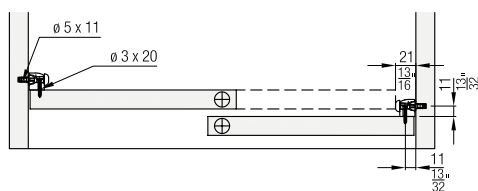
Accessories

	No.
 Clip-on component, for wooden panel, every 500 mm (1'7 11/16"), aluminum, pre-drilled	056.3039.001
 Door centering, for 2 doors, plastic, anthracite	053.3207.071

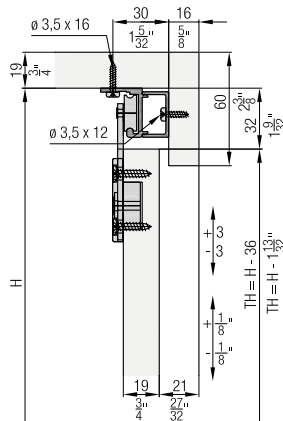
Calculations



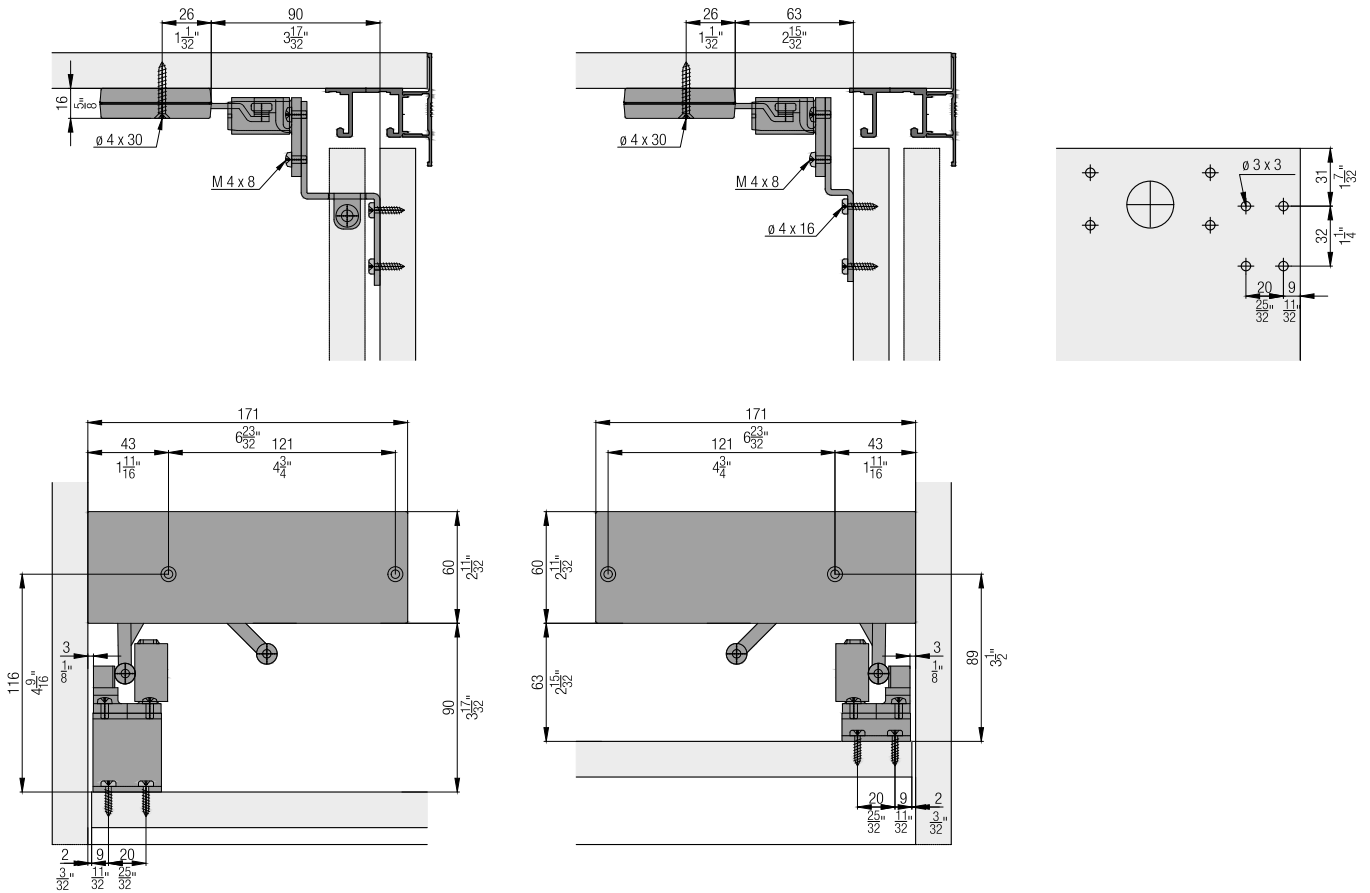
Door centering



Optional: Installation with wooden panel



Soft close



Accessories



- Straightening fitting from page 236
- Handle profiles from page 238
- Order overview soft close from page 240

Planning/execution

Further information about the product can be found on www.hawa.com.

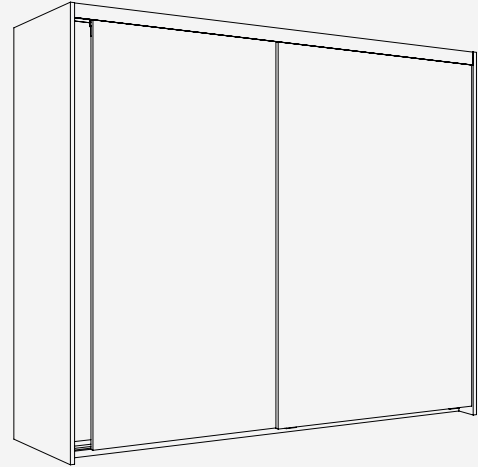
Fitting for 2 top-running wooden doors up to 20 kg (44 lbs.), with screwed on running track and wooden or aluminum clip panel. Soft close optional. Design Mixslide.

Product highlights

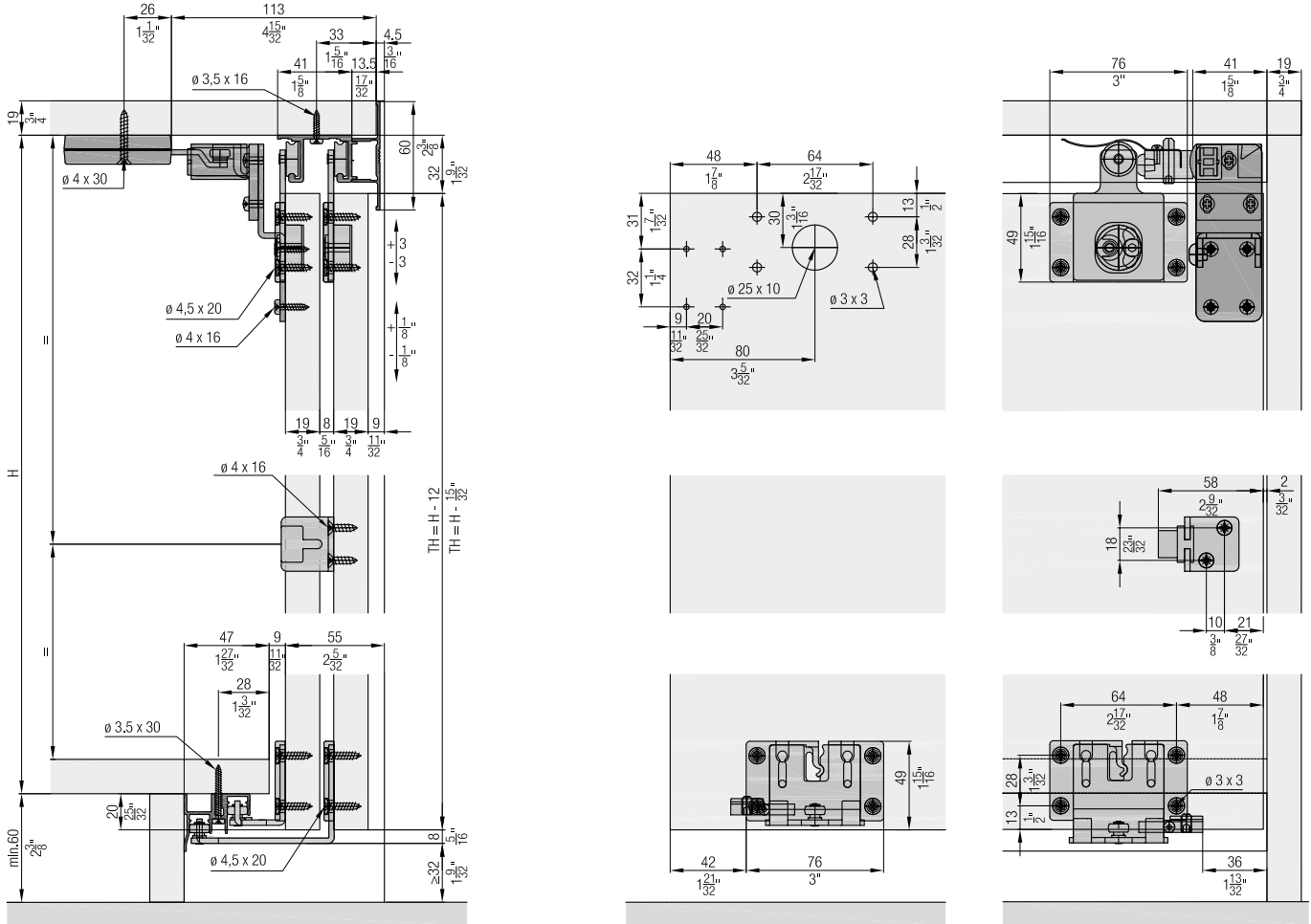
-  **Comfort** High operating convenience thanks to proven running system and optional soft closing technology
-  **Productivity** No cabinet processing, high degree of pre-assembly and access from the front for easy, quick installation

Technical specifications

-  Max. 20 kg (44 lbs.)
-  Max. 2200 mm (7'2 5/8")
-  Max. 1200 mm (3'11 1/4")
-  19 mm (3/4")



Installation examples



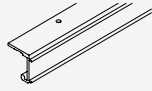
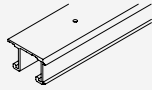
Set for 2 wooden doors

	No.
Hawa Combino 20 H MS, for 2 doors	056.3181.071

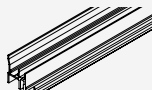
Set consisting of:

		056.3181.071	No.
	Running gear, steel, zinc-plated	4	056.3176.171
	Running gear housing, plastic, anthracite	4	056.3175.001
	Guide bracket, interior door, steel, zinc-plated	2	055.3107.171
	Guide bracket, exterior door, steel, zinc-plated	2	055.3108.171
	Guide bracket housing, plastic, anthracite	4	053.3064.001
	Stopper, plastic, gray	2	056.3189.071
	Stopper, with retention spring, plastic, gray	2	056.3189.072
	Stopper guide, plastic, gray	4	040.3079.074
	Door follower, with 2 doors, steel, zinc-plated	1	055.3124.071
	Countersunk head screw, 4.5x20 mm, steel, zinc-plated	32	600.0000.167


Running tracks

		mm (inch)	No.
	Single running track, aluminum, pre-drilled	2500 (8'2 7/16")	056.3011.250
		3500 (11'5 25/32")	056.3011.350
		6000 (19'8 7/32")	056.3011.600
	Double running track, aluminum, pre-drilled	2500 (8'2 7/16")	056.3010.250
		3500 (11'5 25/32")	056.3010.350
		6000 (19'8 7/32")	056.3010.600

Guide tracks

		mm (inch)	No.
	Double guide track, aluminum, anodized, pre-drilled	2500 (8'2 7/16")	056.3072.250
		3500 (11'5 25/32")	056.3072.350
		6000 (19'8 7/32")	056.3072.600

Panels

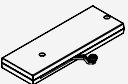
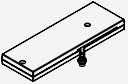




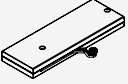
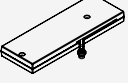
		mm (inch)	No.
	Clip-on panel, aluminum, anodized	2500 (8'2 7/16")	056.3174.250
		3500 (11'5 25/32")	056.3174.350
		6000 (19'8 7/32")	056.3174.600

Soft close

Adapter soft close must be ordered separately

	No.
Soft close, up to 18 kg (40 lbs.), with wide follower, 2 pieces	055.3091.071
Soft close, 18-40 kg (40-88 lbs.), with wide follower, 2 pieces	055.3091.073






Set consisting of:

	055.3091.071	055.3091.073	No.
 Soft close, left, up to 18 kg (40 lbs.)	1		055.3090.071
 Soft close, right, up to 18 kg (40 lbs.)	1		055.3090.072
 Follower, for soft close, right, plastic, gray	1	1	055.3040.071
 Follower, for soft close, left, plastic, gray	1	1	055.3040.072
 Fillister head screw, 4x16 mm, steel, zinc-plated	6	6	600.0000.166
 Countersunk head screw, 4x30 mm, steel, zinc-plated	4	4	600.0000.439
 Soft close, left, 18-40 kg (40-88 lbs.)			1 055.3090.073
 Soft close, right, 18-40 kg (40-88 lbs.)			1 055.3090.074


Adapter soft close for No. 055.3091.071 and 055.3091.073

	No.
Adapter set, for soft close	055.3043.073

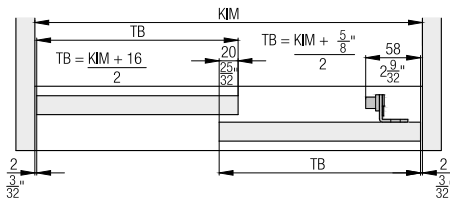
Set consisting of:

	055.3043.073	No.
 Adapter, for soft close, exterior door, steel, zinc-plated	1	055.0133.101
 Adapter, for soft close, interior door, steel, zinc-plated	1	055.0128.101
 Rounded head screw, M4x8 mm, steel, zinc-plated	6	759.0408.108
 Fillister head screw, 4x16 mm, steel, zinc-plated	8	600.0000.166
 Rubber buffer, plastic, grey	1	025.0107.001

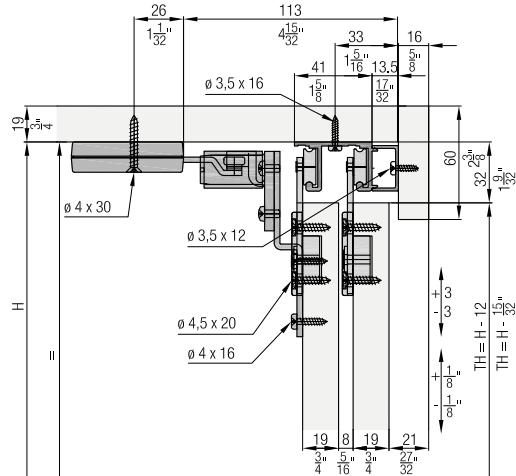
Accessories

	No.
 Clip-on component, for wooden panel, every 500 mm (1'7 11/16"), aluminum, pre-drilled	056.3039.001

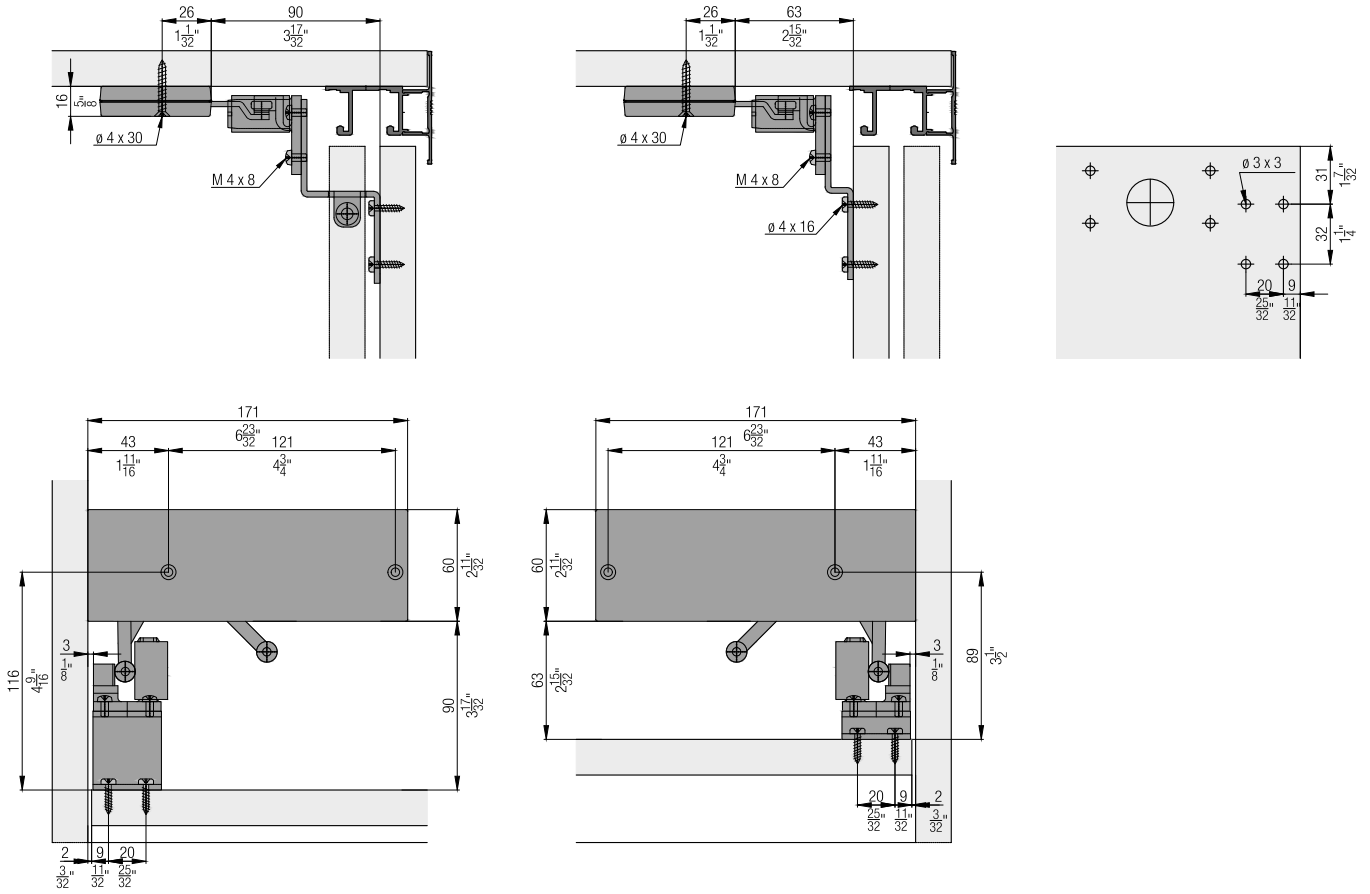
Calculations



Optional: Installation with wooden panel



Soft close



Accessories



- Straightening fitting from page 236
- Handle profiles from page 238
- Order overview soft close from page 240

Planning/execution





Further information about the product can be found on www.hawa.com.

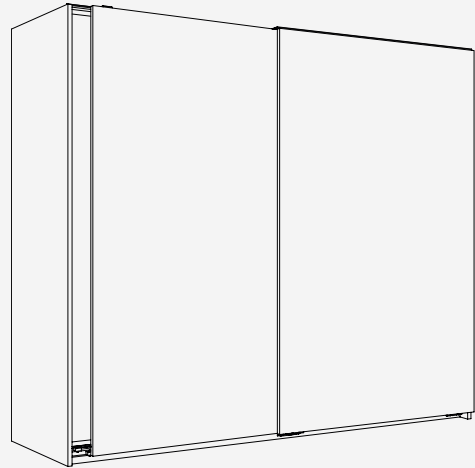
Fitting for 2 bottom-running wooden doors up to 20 kg (44 lbs.) with screwed on running track. Soft close optional. Design Forslide.

Product highlights

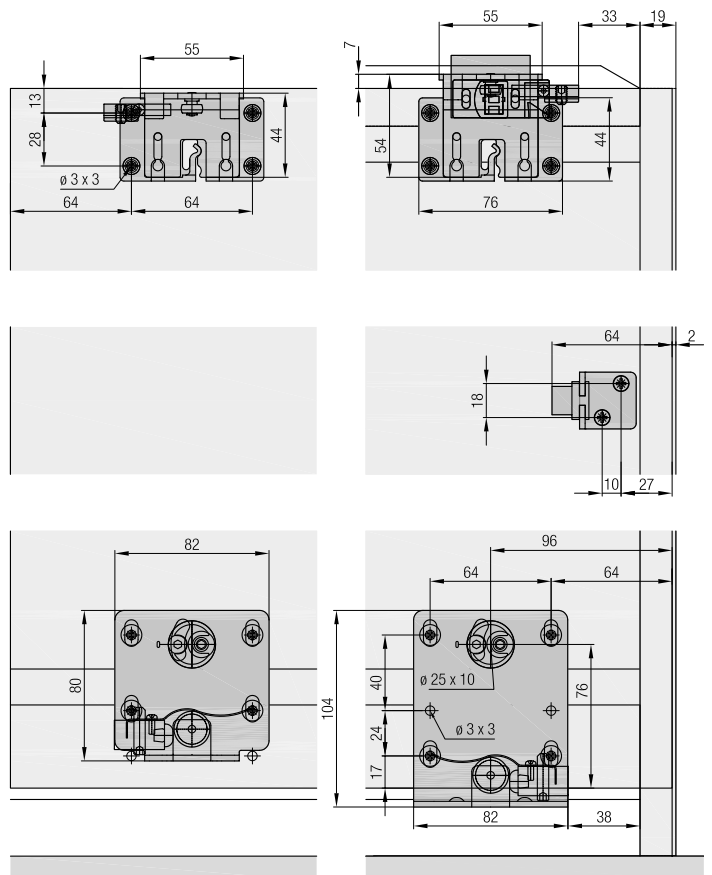
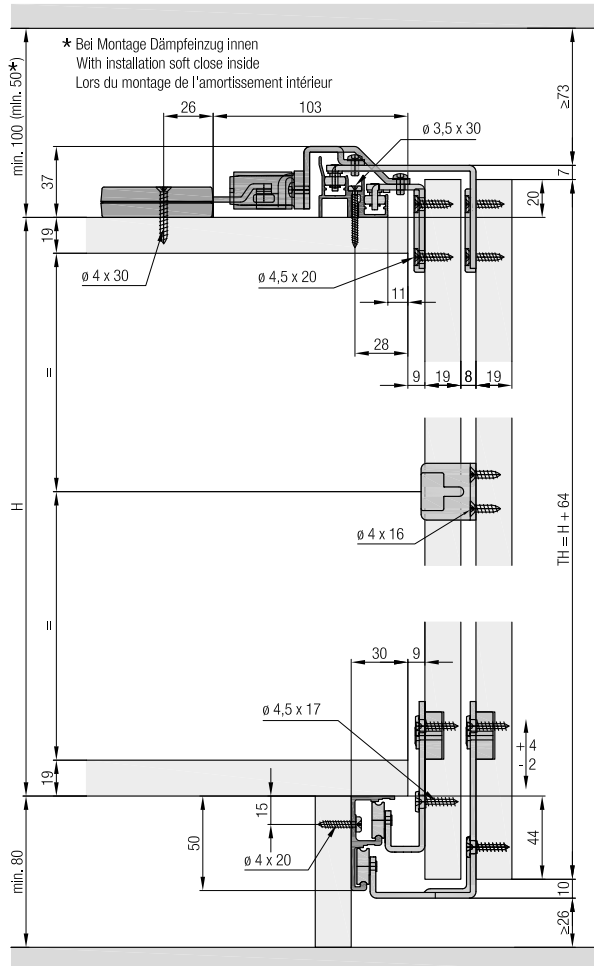
-  **Comfort** High operating convenience thanks to proven running system and optional soft closing technology
-  **Productivity** No cabinet processing, high degree of pre-assembly and access from the front for easy, quick installation

Technical specifications

-  Max. 20 kg (44 lbs.)
-  Max. 2200 mm (7'2 5/8")
-  Max. 1200 mm (3'11 1/4")
-  19 mm (3/4")














Installation examples



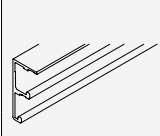
Set for 2 wooden doors

	No.
Hawa Combino 20 H FS, for 2 doors	056.3182.071

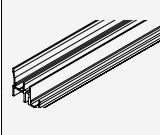
Set consisting of:

		056.3182.071	No.
	Running gear, interior door, steel, zinc-plated	2	056.3185.171
	Running gear, exterior door, steel, zinc-plated	2	056.3186.171
	Guide bracket, interior door, steel, zinc-plated	2	055.3107.171
	Guide bracket, exterior door, steel, zinc-plated	2	055.3108.171
	Guide bracket housing, plastic, anthracite	4	053.3064.001
	Stopper, plastic, gray	2	056.3189.071
	Stopper, with retention spring, plastic, gray	2	056.3189.072
	Stopper guide, plastic, gray	4	040.3079.074
	Door follower, with 2 doors, steel, zinc-plated	1	055.3124.071
	Washer-and-screw assembly, 4.5x17 mm, steel, zinc-plated	16	055.0100.101
	Countersunk head screw, 4.5x20 mm, steel, zinc-plated	16	600.0000.167

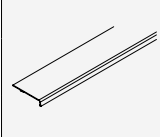
Running tracks

		mm (inch)	No.
	Double running track, aluminum, anodized, pre-drilled	2500 (8'2 7/16")	056.3184.250
		3500 (11'5 25/32")	056.3184.350
		6000 (19'8 7/32")	056.3184.600

Guide tracks

		mm (inch)	No.
	Double guide track, aluminum, anodized, pre-drilled	2500 (8'2 7/16")	056.3072.250
		3500 (11'5 25/32")	056.3072.350
		6000 (19'8 7/32")	056.3072.600

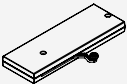
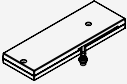




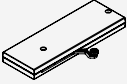

Panels

		mm (inch)	No.
	Cover panel, aluminum, anodized	2500 (8'2 7/16")	055.3130.250
		3500 (11'5 25/32")	055.3130.350
		6000 (19'8 7/32")	055.3130.600

Soft close (installation outside)

	No.
Soft close, up to 18 kg (40 lbs.), with narrow follower, 2 pieces	055.3091.072
Soft close, 18-40 kg (40-88 lbs.), with narrow follower, 2 pieces	055.3091.074





Set consisting of:

		055.3091.072	055.3091.074	No.
	Soft close, left, up to 18 kg (40 lbs.)	1		055.3090.071
	Soft close, right, up to 18 kg (40 lbs.)	1		055.3090.072
	Follower, for soft close, right, plastic, gray	1	1	055.3041.071
	Follower, for soft close, left, plastic, gray	1	1	055.3041.072
	Fillister head screw, 4x16 mm, steel, zinc-plated	4	4	600.0000.166
	Countersunk head screw, 4x30 mm, steel, zinc-plated	4	4	600.0000.439
	Soft close, left, 18-40 kg (40-88 lbs.)		1	055.3090.073
	Soft close, right, 18-40 kg (40-88 lbs.)		1	055.3090.074

Adapter soft close (installation outside) for No. 055.3091.072 and 055.3091.074

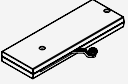
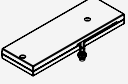




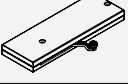

	No.
Adapter set, for soft close	055.3129.071

Set consisting of:

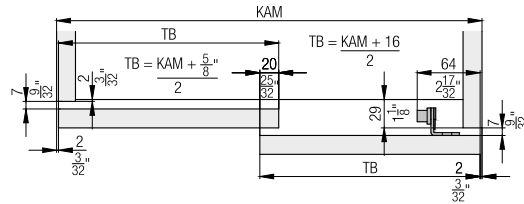
		055.3129.071	No.
	Adapter, for soft close, interior door, top, steel, zinc-plated	1	055.0211.101
	Adapter, for soft close, exterior door, top, steel, zinc-plated	1	055.0212.101
	Rounded head screw, M4x8 mm, steel, zinc-plated	4	759.0408.108
	Thread-cutting rounded head screw, M4x8 mm, steel, zinc-plated	4	600.0000.328

Soft close (installation inside)

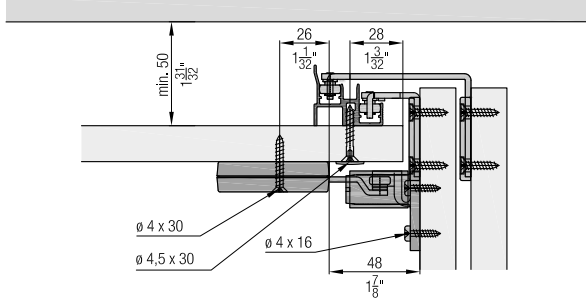
	No.
Soft close, up to 18 kg (40 lbs.), with wide follower, 2 pieces	055.3091.071
Soft close, 18–40 kg (40–88 lbs.), with wide follower, 2 pieces	055.3091.073

Set consisting of:	055.3091.071		055.3091.073		No.
 Soft close, left, up to 18 kg (40 lbs.)	1				055.3090.071
 Soft close, right, up to 18 kg (40 lbs.)	1				055.3090.072
 Follower, for soft close, right, plastic, gray	1	1			055.3040.071
 Follower, for soft close, left, plastic, gray	1	1			055.3040.072
 Fillister head screw, 4x16 mm, steel, zinc-plated	6	6			600.0000.166
 Countersunk head screw, 4x30 mm, steel, zinc-plated	4	4			600.0000.439
 Soft close, left, 18–40 kg (40–88 lbs.)			1		055.3090.073
 Soft close, right, 18–40 kg (40–88 lbs.)			1		055.3090.074

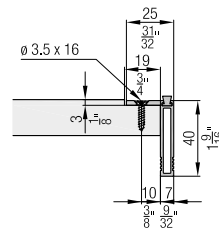
Calculations



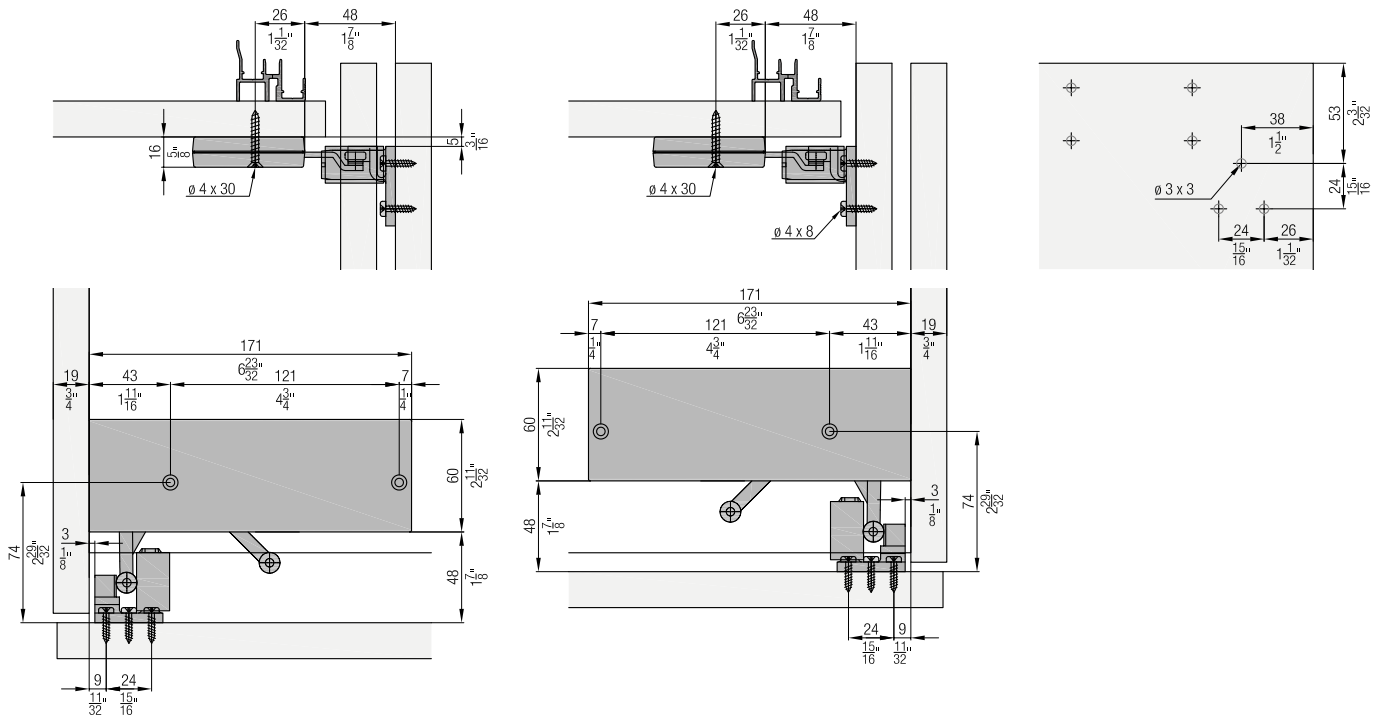
Optional: Guide track installation from below



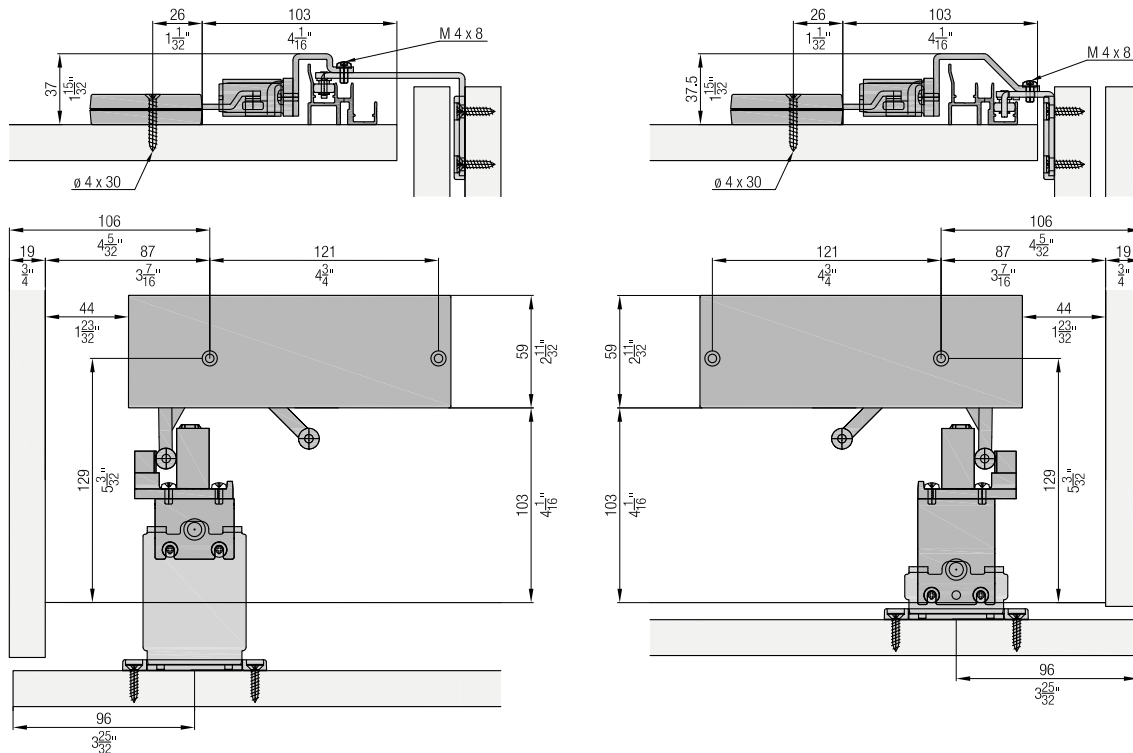
Handle profiles



Soft close (installation inside)



Soft close (installation outside)



Accessories



- Straightening fitting from page 236
- Handle profiles from page 238
- Order overview soft close from page 240

Planning/execution




Further information about the product can be found on www.hawa.com.

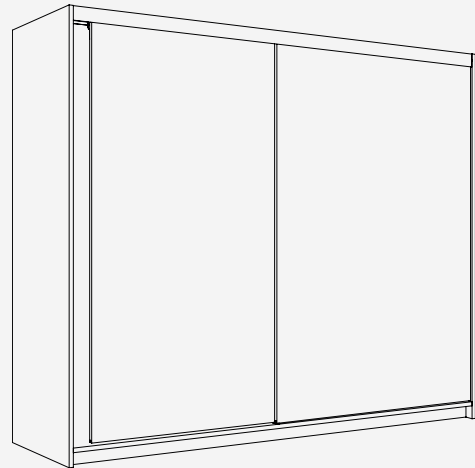
Fitting for 2-3 top-running wooden doors up to 35 kg (77 lbs.), with screwed on running track and wooden or aluminum clip panel. Soft close optional. Design Inside.

Product highlights

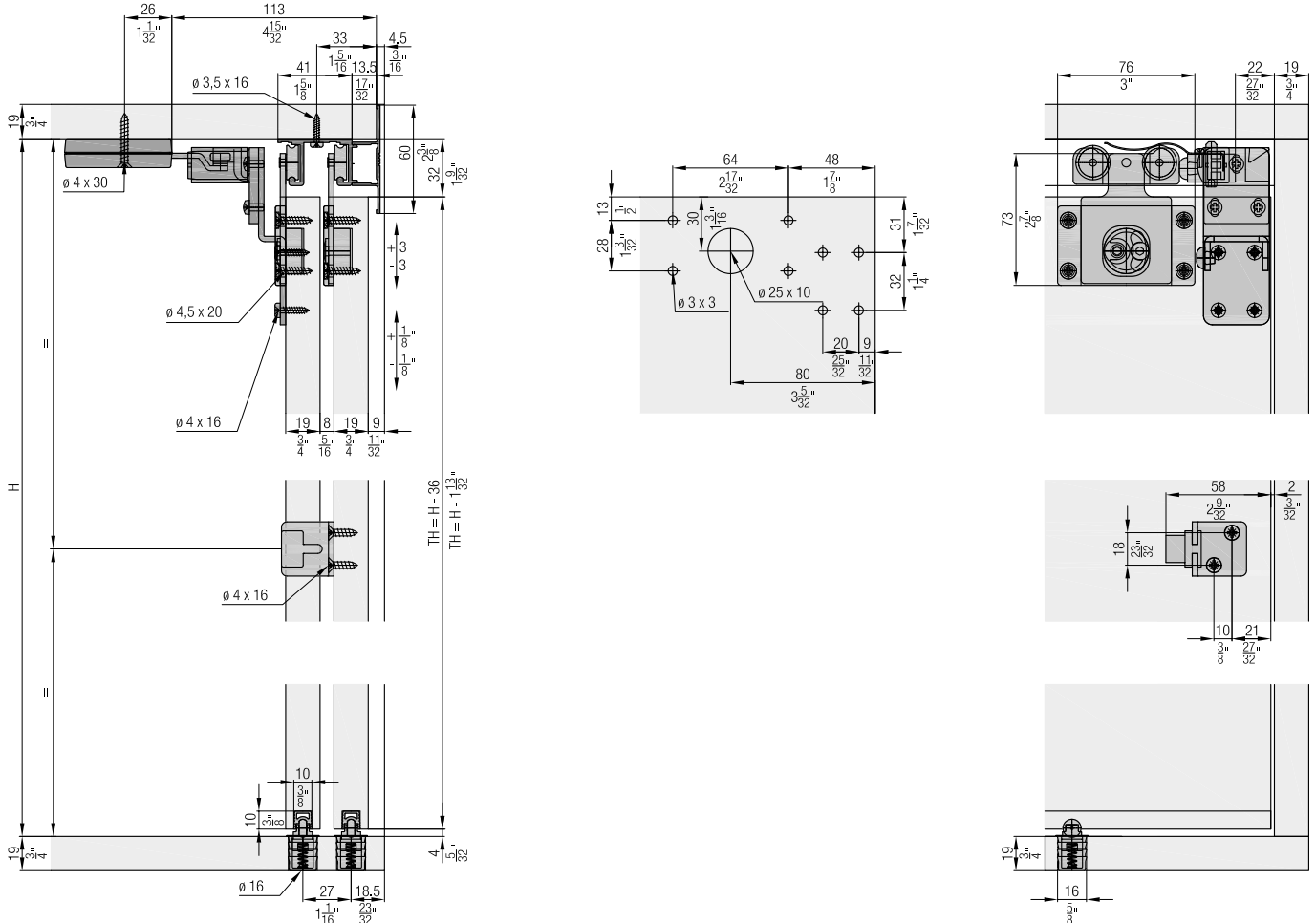
-  **Comfort** High operating convenience thanks to proven running system and optional soft closing technology
-  **Productivity** No cabinet processing, high degree of pre-assembly and access from the front for easy, quick installation

Technical specifications

-  Max. 35 kg (77 lbs.)
-  Max. 2200 mm (7'2 5/8")
-  Max. 1200 mm (3'11 1/4")
-  19 mm (3/4")



Installation examples



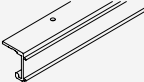
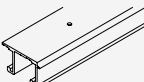
Set for 2 or 3 wooden doors

	No.
Hawa Combino 35 H IS, for 2 doors	056.3180.073
Hawa Combino 35 H IS, for 3 doors	056.3180.077

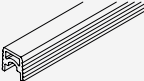
Set consisting of:

		056.3180.073	056.3180.077	No.
	Running gear, steel, zinc-plated	4	6	056.3177.171
	Running gear housing, plastic, anthracite	4	6	056.3175.001
	Bottom guide, plastic, gray	2	3	055.3081.071
	Stopper, plastic, gray	2	1	056.3189.071
	Stopper, with retention spring, plastic, gray	2	3	056.3189.072
	Door follower, with 2 doors, steel, zinc-plated	1		055.3124.071
	Countersunk head screw, 4.5x20 mm, steel, zinc-plated	16	24	600.0000.167
	Buffer, with adhesive, 3-piece set		1	061.3083.050


Running tracks

		mm (inch)	No.
	Single running track, aluminum, pre-drilled	2500 (8'2 7/16")	056.3011.250
		3500 (11'5 25/32")	056.3011.350
		6000 (19'8 7/32")	056.3011.600
	Double running track, aluminum, pre-drilled	2500 (8'2 7/16")	056.3010.250
		3500 (11'5 25/32")	056.3010.350
		6000 (19'8 7/32")	056.3010.600

Guide tracks

		mm (inch)	No.
	Guide track, plastic, gray, for glue fixing	2500 (8'2 7/16")	055.3171.250
		3500 (11'5 25/32")	055.3171.350
		6000 (19'8 7/32")	055.3171.600

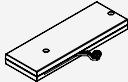
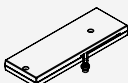




Panels

		mm (inch)	No.
	Clip-on panel, aluminum, anodized	2500 (8'2 7/16")	056.3174.250
		3500 (11'5 25/32")	056.3174.350
		6000 (19'8 7/32")	056.3174.600

Soft close (only for system with 2 doors)
Adapter soft close must be ordered separately

	No.
Soft close, 18–40 kg (40–88 lbs.), with wide follower, 2 pieces	055.3091.073






Set consisting of:

		055.3091.073	No.
	Soft close, left, 18–40 kg (40–88 lbs.)	1	055.3090.073
	Soft close, right, 18–40 kg (40–88 lbs.)	1	055.3090.074
	Follower, for soft close, right, plastic, gray	1	055.3040.071
	Follower, for soft close, left, plastic, gray	1	055.3040.072
	Fillister head screw, 4x16 mm, steel, zinc-plated	6	600.0000.166
	Countersunk head screw, 4x30 mm, steel, zinc-plated	4	600.0000.439


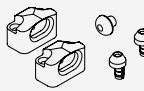
Adapter soft close for No. 055.3091.073

	No.
Adapter set, for soft close	055.3043.073

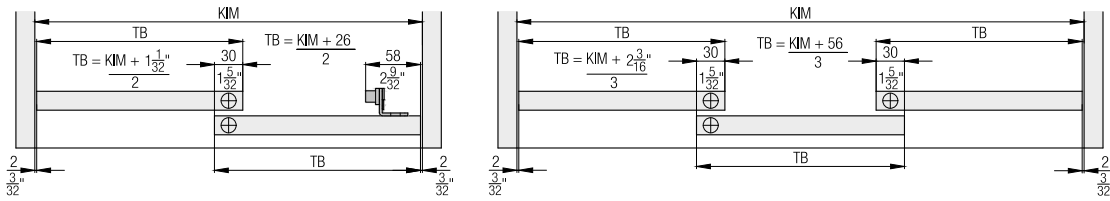
Set consisting of:

		055.3043.073	No.
	Adapter, for soft close, exterior door, steel, zinc-plated	1	055.0133.101
	Adapter, for soft close, interior door, steel, zinc-plated	1	055.0128.101
	Rounded head screw, M4x8 mm, steel, zinc-plated	6	759.0408.108
	Fillister head screw, 4x16 mm, steel, zinc-plated	8	600.0000.166
	Rubber buffer, plastic, grey	1	025.0107.001

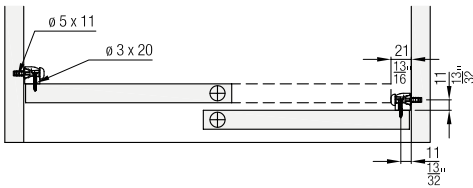
Accessories

		No.
	Clip-on component, for wooden panel, every 500 mm (1'7 11/16"), aluminum, pre-drilled	056.3039.001
	Door centering, for 2 doors, plastic, anthracite	053.3207.071

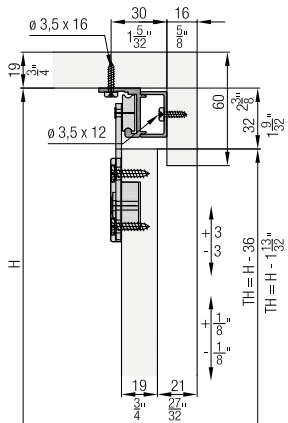
Calculations



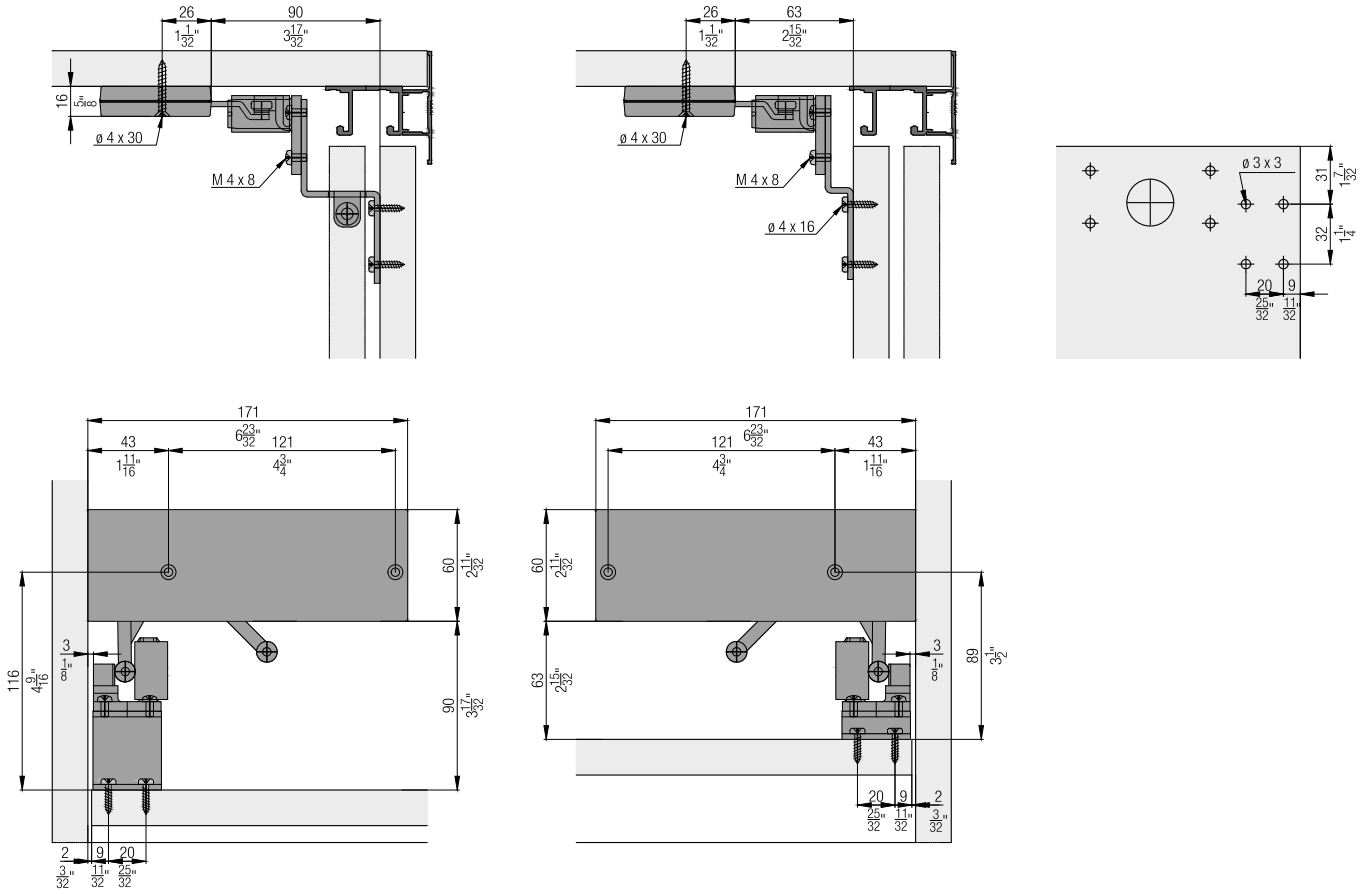
Door centering



Optional: Installation with wooden panel



Soft close (only for system with 2 doors)



Accessories



- Straightening fitting from page 236
- Handle profiles from page 238
- Order overview soft close from page 240

Planning/execution




Further information about the product can be found on www.hawa.com.

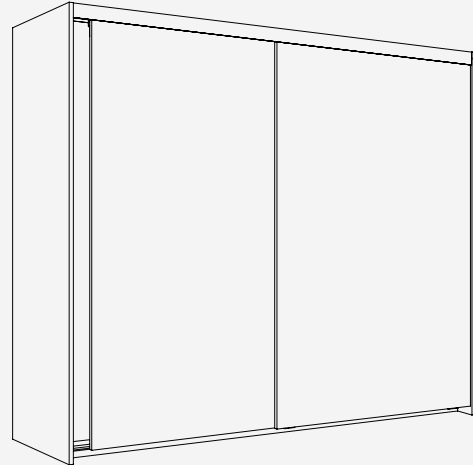
Fitting for 2–3 top-running wooden doors up to 35 kg (77 lbs.), with screwed on running track and wooden or aluminum clip panel. Soft close optional. Design Mixslide.

Product highlights

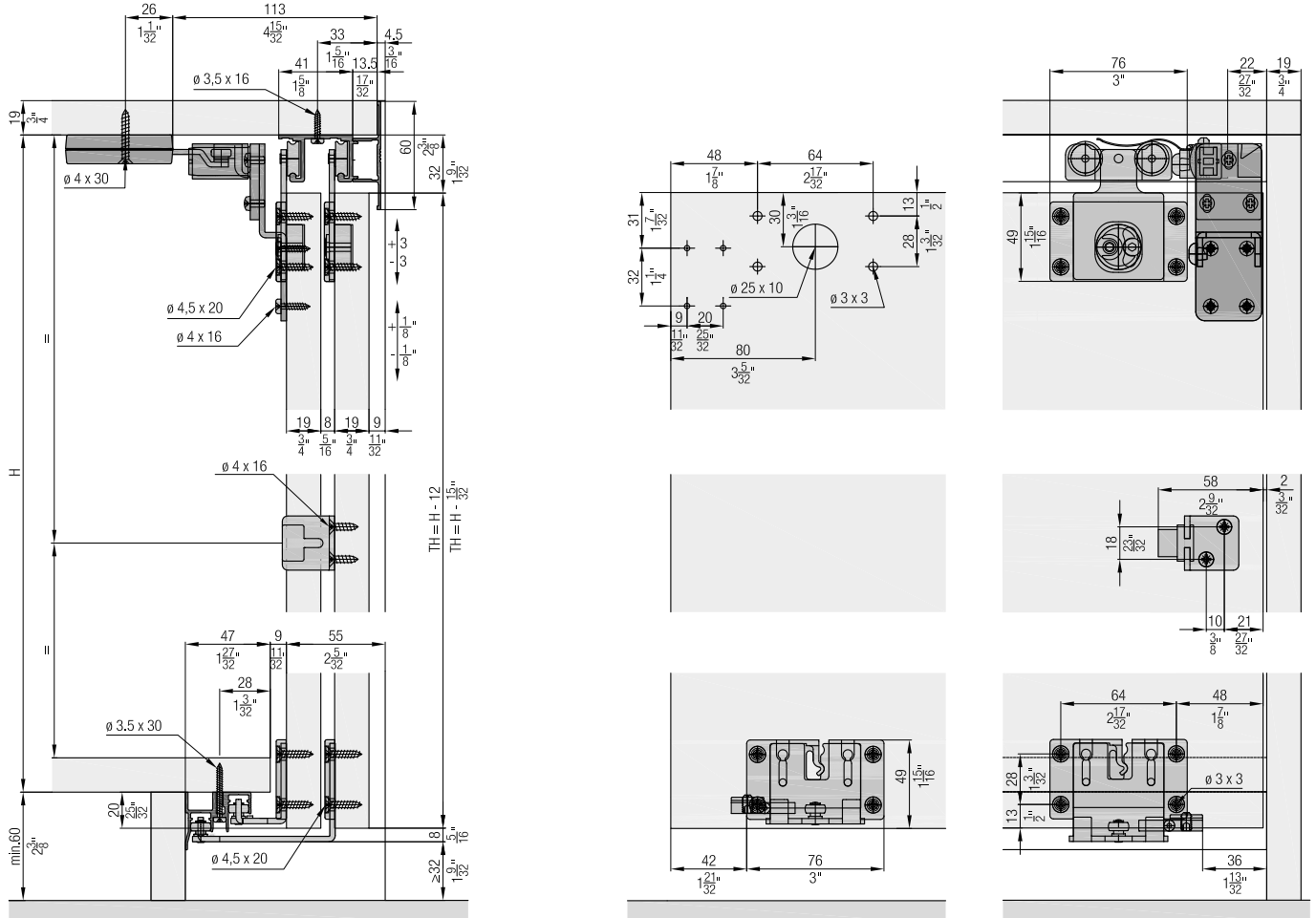
-  **Comfort** High operating convenience thanks to proven running system and optional soft closing technology
-  **Productivity** No cabinet processing, high degree of pre-assembly and access from the front for easy, quick installation

Technical specifications

-  Max. 35 kg (77 lbs.)
-  Max. 2200 mm (7'2 5/8")
-  Max. 1200 mm (3'11 1/4")
-  19 mm (3/4")









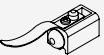






Installation examples



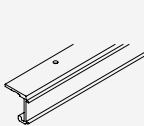
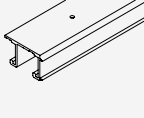
Set for 2 or 3 wooden doors

	Nr.
Hawa Combino 35 H MS, for 2 doors	056.3181.073
Hawa Combino 35 H MS, for 3 doors	056.3181.074

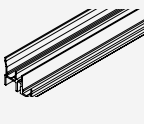
Set consisting of:

		056.3181.073	056.3181.074	Nr.
	Running gear, steel, zinc-plated	4	6	056.3177.171
	Running gear housing, plastic, anthracite	4	6	056.3175.001
	Guide bracket, interior door, steel, zinc-plated	2	4	055.3107.171
	Guide bracket, exterior door, steel, zinc-plated	2	2	055.3108.171
	Guide bracket housing, plastic, anthracite	4	6	053.3064.001
	Stopper, plastic, gray	2	1	056.3189.071
	Stopper, with retention spring, plastic, gray	2	3	056.3189.072
	Stopper guide, plastic, gray	4	4	040.3079.074
	Door follower, with 2 doors, steel, zinc-plated	1		055.3124.071
	Countersunk head screw, 4.5x20 mm, steel, zinc-plated	32	48	600.0000.167
	Buffer, with adhesive, 3-piece set		1	061.3083.050
	Door follower, with 3 doors, steel, zinc-plated		2	055.3126.171
	Thread-cutting rounded head screw, M4x8 mm, steel, zinc-plated		2	600.0000.328

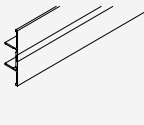
Running tracks

		mm (inch)	Nr.
	Single running track, aluminum, pre-drilled	2500 (8'2 7/16")	056.3011.250
		3500 (11'5 25/32")	056.3011.350
		6000 (19'8 7/32")	056.3011.600
	Double running track, aluminum, pre-drilled	2500 (8'2 7/16")	056.3010.250
		3500 (11'5 25/32")	056.3010.350
		6000 (19'8 7/32")	056.3010.600

Guide tracks

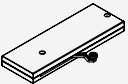





		mm (inch)	Nr.
	Double guide track, aluminum, anodized, pre-drilled	2500 (8'2 7/16")	056.3072.250
		3500 (11'5 25/32")	056.3072.350
		6000 (19'8 7/32")	056.3072.600

Panels

		mm (inch)	Nr.
	Clip-on panel, aluminum, anodized	2500 (8'2 7/16")	056.3174.250
		3500 (11'5 25/32")	056.3174.350
		6000 (19'8 7/32")	056.3174.600






Soft close (only for system with 2 doors)
Adapter soft close must be ordered separately

	Nr.
Soft close, 18–40 kg (40–88 lbs.), with wide follower, 2 pieces	055.3091.073


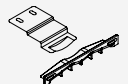
Set consisting of:		055.3091.073	Nr.
	Soft close, left, 18–40 kg (40–88 lbs.)	1	055.3090.073
	Soft close, right, 18–40 kg (40–88 lbs.)	1	055.3090.074
	Follower, for soft close, right, plastic, gray	1	055.3040.071
	Follower, for soft close, left, plastic, gray	1	055.3040.072
	Fillister head screw, 4x16 mm, steel, zinc-plated	6	600.0000.166
	Countersunk head screw, 4x30 mm, steel, zinc-plated	4	600.0000.439

Adapter soft close for No. 055.3091.073

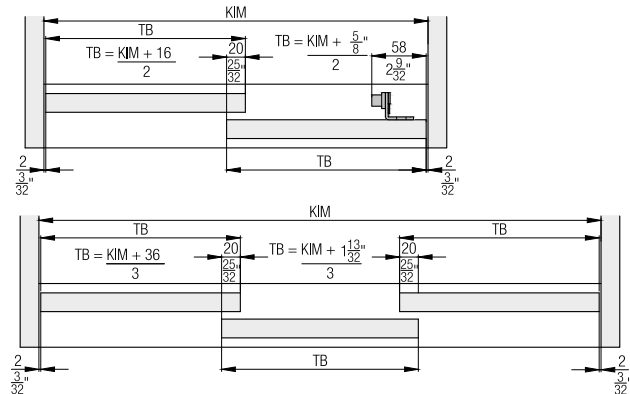
	Nr.
Adapter set, for soft close	055.3043.073

Set consisting of:		055.3043.073	Nr.
	Adapter, for soft close, exterior door, steel, zinc-plated	1	055.0133.101
	Adapter, for soft close, interior door, steel, zinc-plated	1	055.0128.101
	Rounded head screw, M4x8 mm, steel, zinc-plated	6	759.0408.108
	Fillister head screw, 4x16 mm, steel, zinc-plated	8	600.0000.166
	Rubber buffer, plastic, grey	1	025.0107.001

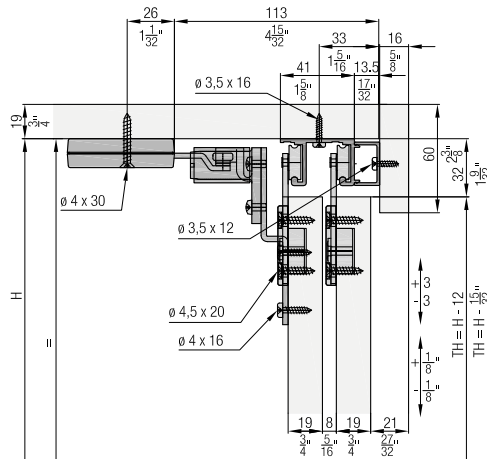
Accessories

	Nr.	
	Clip-on component, for wooden panel, every 500 mm (1'7 11/16"), aluminum, pre-drilled	056.3039.001
	Intermediate stop set, for 3 doors	056.3035.071

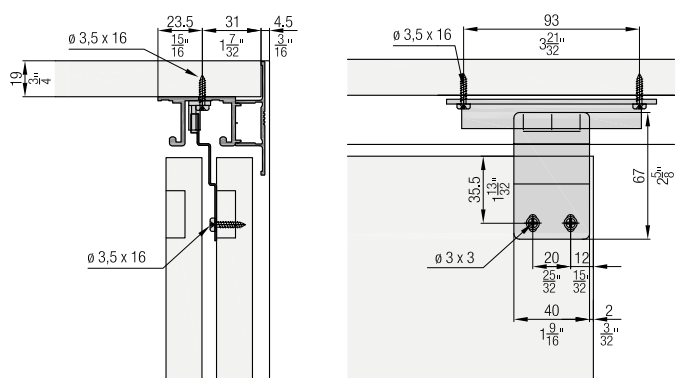
Calculations



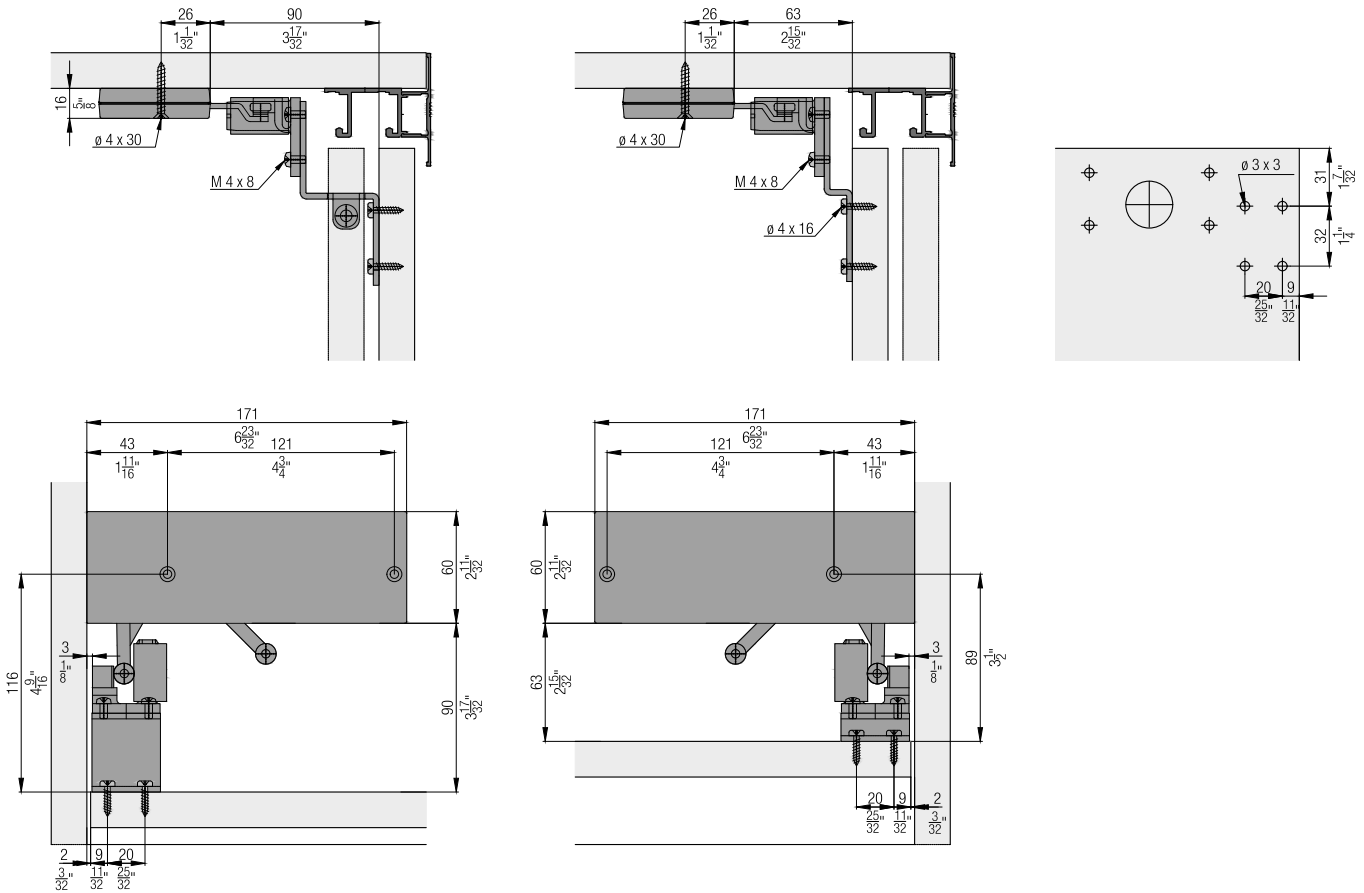
Optional: Installation with wooden panel



Intermediate stop with 3 doors



Soft close (only for system with 2 doors)



Accessories

- Straightening fitting from page 236
- Handle profiles from page 238
- Order overview soft close from page 240

Planning/execution

Further information about the product can be found on www.hawa.com.

Fitting for 2–3 bottom-running wooden doors up to 35 kg (77 lbs.) with screwed on running track. Soft close optional. Design Forslide.

Product highlights



Comfort High operating convenience thanks to proven running system and optional soft closing technology



Productivity No cabinet processing, high degree of pre-assembly and access from the front for easy, quick installation

Technical specifications



Max. 35 kg (77 lbs.)



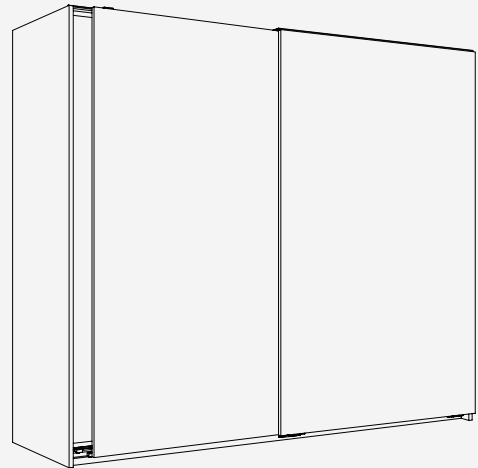
Max. 2200 mm (7'2 5/8")



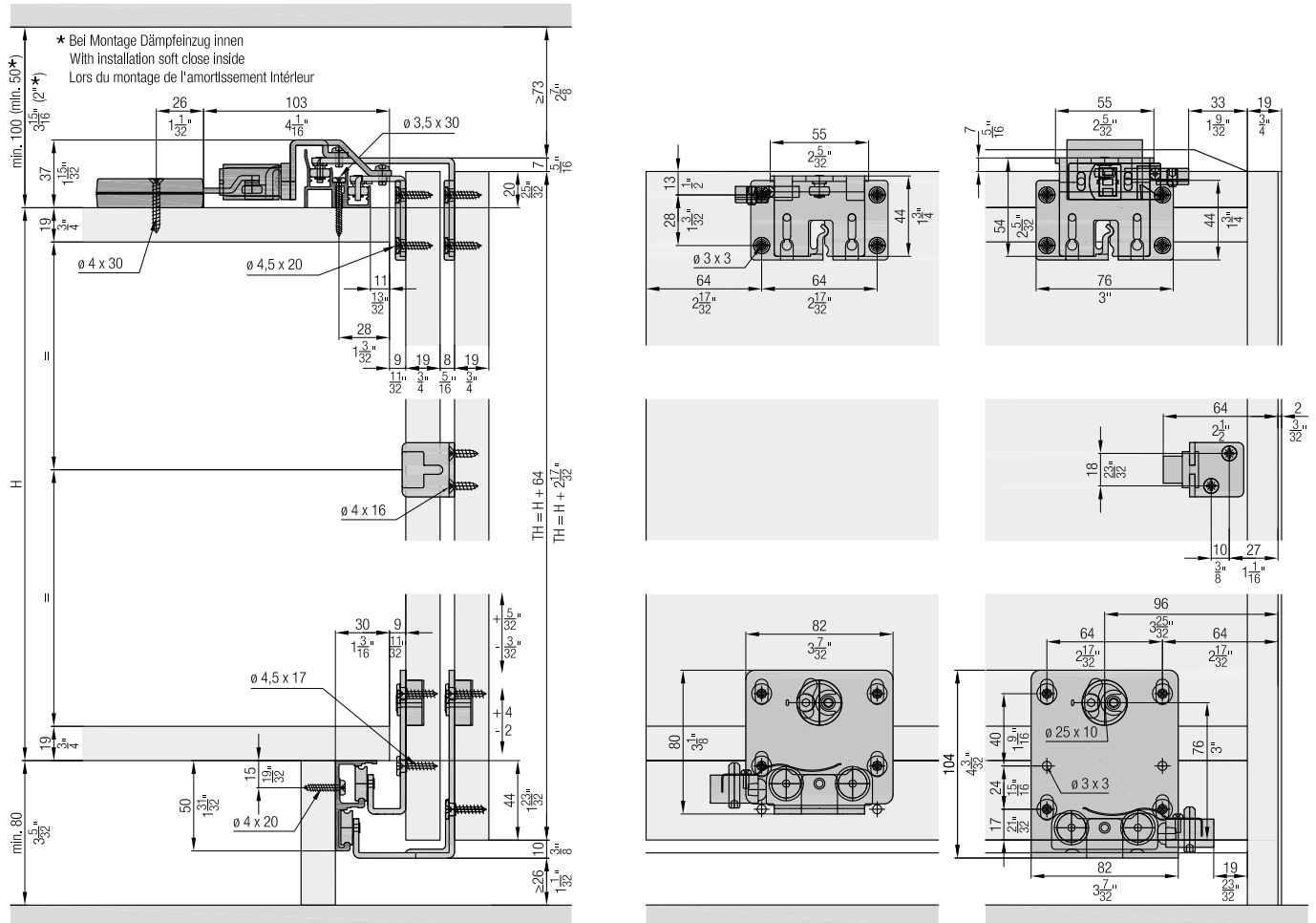
Max. 1200 mm (3'11 1/4")



19 mm (3/4")



Installation examples



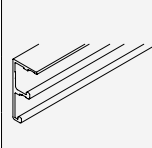
Set for 2 wooden doors

	Nr.
Hawa Combino 35 H FS, for 2 doors	056.3182.073
Hawa Combino 35 H FS, for 3 doors	056.3182.074

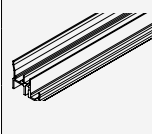
Set consisting of:

		056.3182.073	056.3182.074	Nr.
	Running gear, interior door, steel, zinc-plated	2	4	056.3187.171
	Running gear, exterior door, steel, zinc-plated	2	2	056.3188.171
	Guide bracket, interior door, steel, zinc-plated	2	4	055.3107.171
	Guide bracket, exterior door, steel, zinc-plated	2	2	055.3108.171
	Guide bracket housing, plastic, anthracite	4	6	053.3064.001
	Stopper, plastic, gray	2	1	056.3189.071
	Stopper, with retention spring, plastic, gray	2	3	056.3189.072
	Stopper guide, plastic, gray	4	4	040.3079.074
	Door follower, with 2 doors, steel, zinc-plated	1		055.3124.071
	Washer and screw assembly, 4.5x17 mm, steel, zinc-plated	16	24	055.0100.101
	Countersunk head screw, 4.5x20 mm, steel, zinc-plated	16	24	600.0000.167
	Buffer, with adhesive, 3-piece set		1	061.3083.050
	Door follower, with 3 doors, steel, zinc-plated		2	055.3126.171
	Thread-cutting rounded head screw, M4x8 mm, steel, zinc-plated		2	600.0000.328

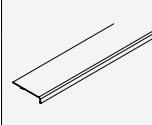
Running tracks

		mm (inch)	Nr.
	Double running track, aluminum, anodized, pre-drilled	2500 (8'2 7/16")	056.3184.250
		3500 (11'5 25/32")	056.3184.350
		6000 (19'8 7/32")	056.3184.600

Guide tracks

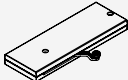
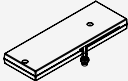




		mm (inch)	Nr.
	Double guide track, aluminum, anodized, pre-drilled	2500 (8'2 7/16")	056.3072.250
		3500 (11'5 25/32")	056.3072.350
		6000 (19'8 7/32")	056.3072.600

Panels

		mm (inch)	Nr.
	Cover panel, aluminum, anodized	2500 (8'2 7/16")	055.3130.250
		3500 (11'5 25/32")	055.3130.350
		6000 (19'8 7/32")	055.3130.600





**Soft close (installation outside)
(only for system with 2 doors)
Adapter soft close (installation outside)
must be ordered separately**

	Nr.
Soft close, 18–40 kg (40–88 lbs.), with narrow follower, 2 pieces	055.3091.074

		055.3091.074	Nr.
Set consisting of:			
	Soft close, left, 18–40 kg (40–88 lbs.)	1	055.3090.073
	Soft close, right, 18–40 kg (40–88 lbs.)	1	055.3090.074
	Follower, for soft close, right, plastic, gray	1	055.3041.071
	Follower, for soft close, left, plastic, gray	1	055.3041.072
	Fillister head screw, 4x16 mm, steel, zinc-plated	4	600.0000.166
	Countersunk head screw, 4x30 mm, steel, zinc-plated	4	600.0000.439


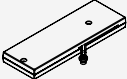




**Adapter soft close (installation outside)
for No. 055.3091.074**

	Nr.
Adapter set, for soft close	055.3129.071

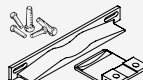
		055.3129.071	Nr.
Set consisting of:			
	Adapter, for soft close, interior door, top, steel, zinc-plated	1	055.0211.101
	Adapter, for soft close, exterior door, top, steel, zinc-plated	1	055.0212.101
	Rounded head screw, M4x8 mm, steel, zinc-plated	4	759.0408.108
	Thread-cutting rounded head screw, M4x8 mm, steel, zinc-plated	4	600.0000.328

**Soft close (installation inside)
(only for system with 2 doors)**

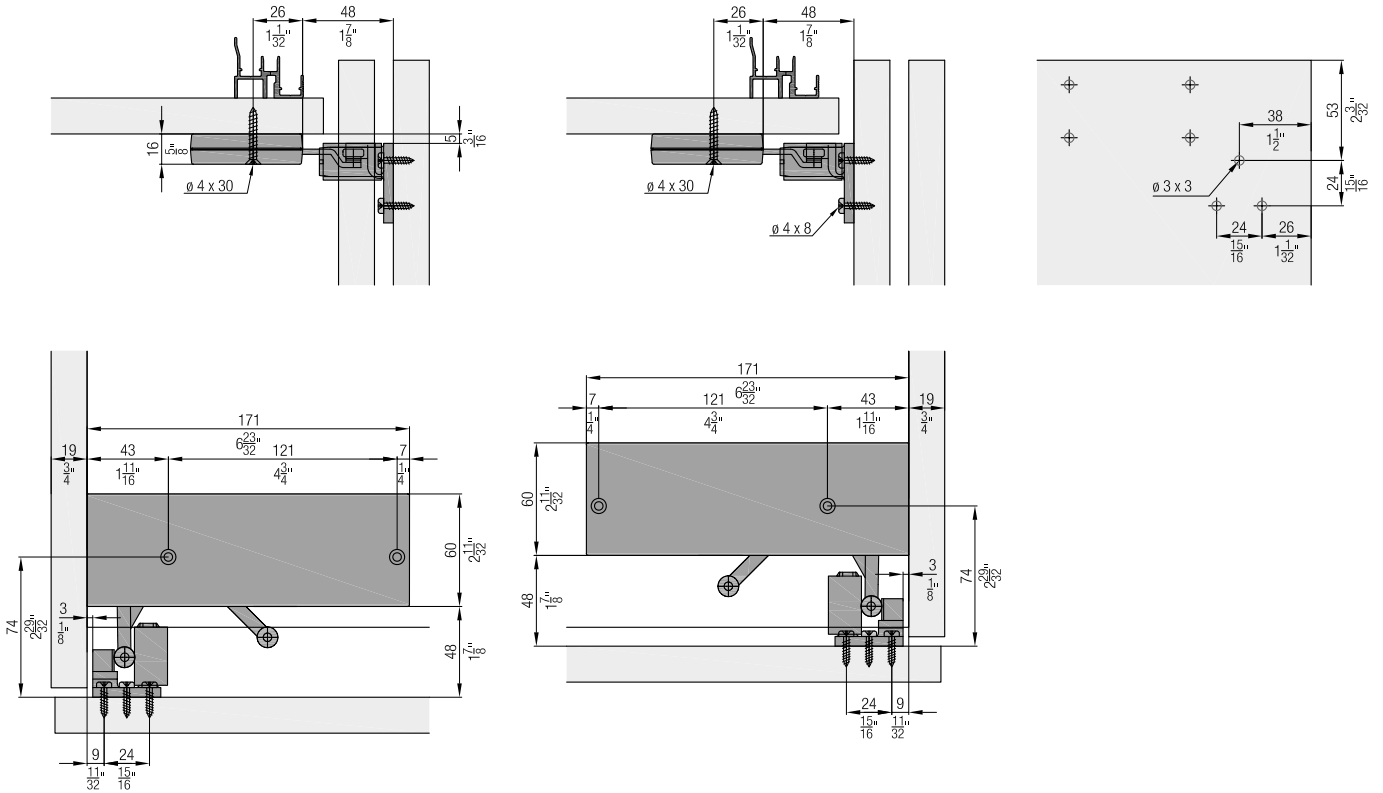
	Nr.
Soft close, 18–40 kg (40–88 lbs.), with wide follower, 2 pieces	055.3091.073

		055.3091.073	Nr.
Set consisting of:			
	Soft close, left, 18–40 kg (40–88 lbs.)	1	055.3090.073
	Soft close, right, 18–40 kg (40–88 lbs.)	1	055.3090.074
	Follower, for soft close, right, plastic, gray	1	055.3040.071
	Follower, for soft close, left, plastic, gray	1	055.3040.072
	Fillister head screw, 4x16 mm, steel, zinc-plated	6	600.0000.166
	Countersunk head screw, 4x30 mm, steel, zinc-plated	4	600.0000.439

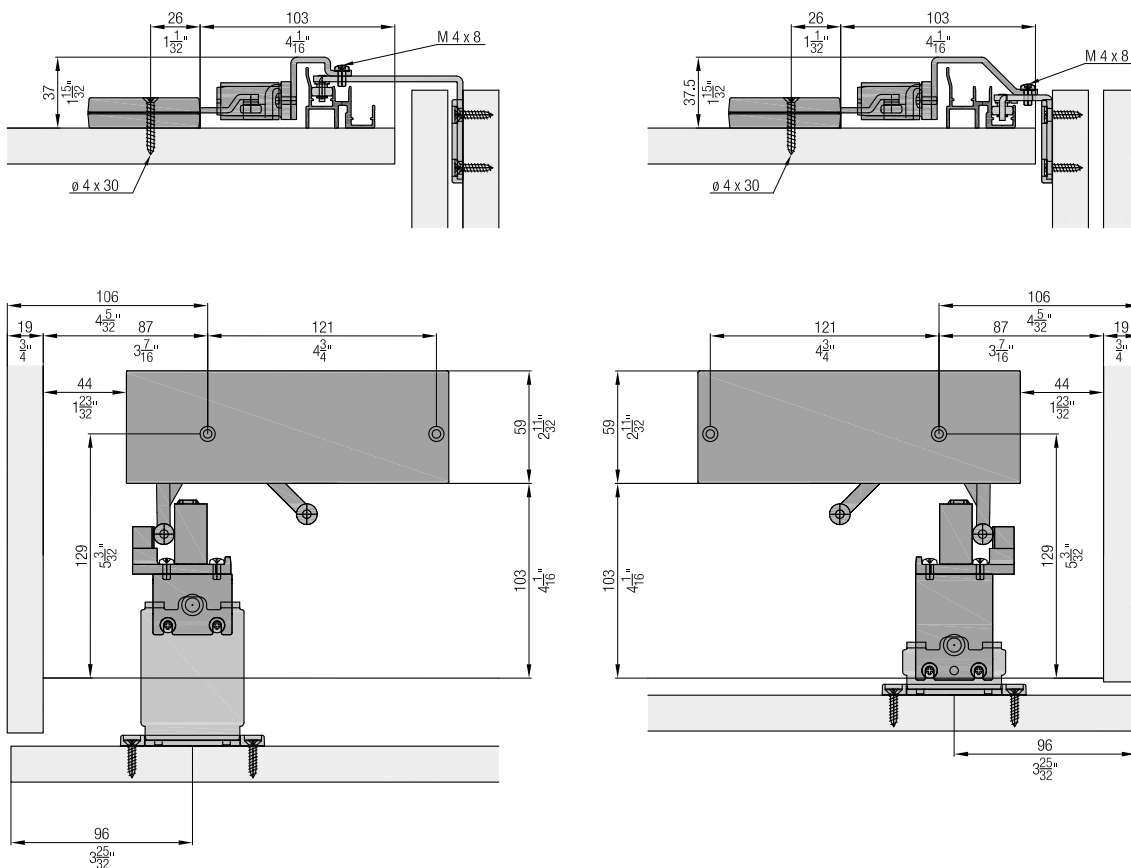
Accessories

	Nr.	
	Intermediate stop set, for 3 doors	055.3128.071

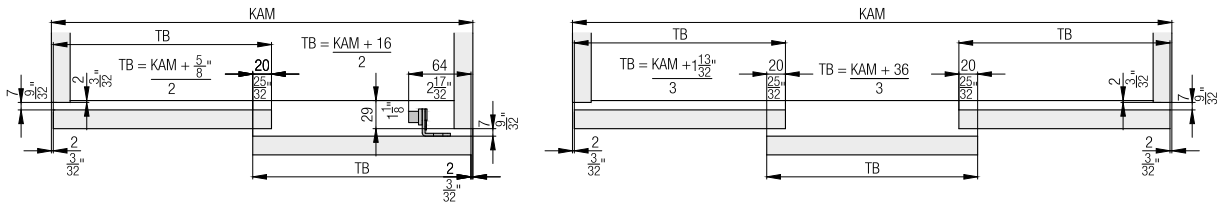
Soft close installation inside (only for system with 2 doors)



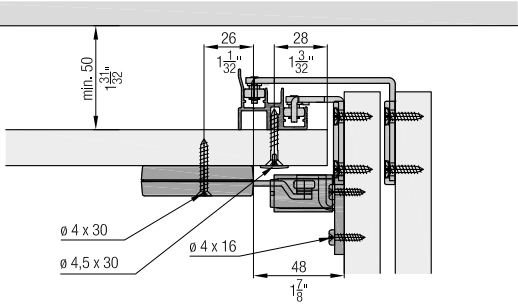
Soft close installation outside (only for system with 2 doors)



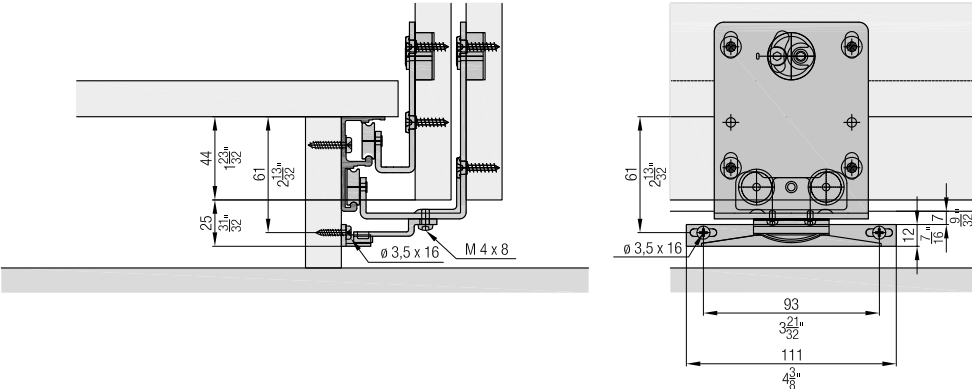
Calculations



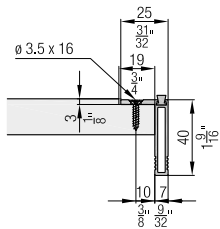
Optional: Guide track installation from below



Intermediate stop with 3 doors



Handle profile



Accessories

- Straightening fitting from page 236
- Handle profiles from page 238
- Order overview soft close from page 240

Planning/execution

Further information about the product can be found on www.hawa.com.

Fitting for 2–3 bottom-running wooden doors (19/25 mm) up to 50 kg (110 lbs.) with screwed on running track and integrated soft close. Design Mixslide

Product highlights



Comfort

Sophisticated soft closing system and innovation arrangement of the components for very easy operation



Aesthetics

Bottom-running system that supports the entire door weight on the base makes cabinet designs with thin materials possible

Technical specifications



Max. 50 kg (110 lbs.)



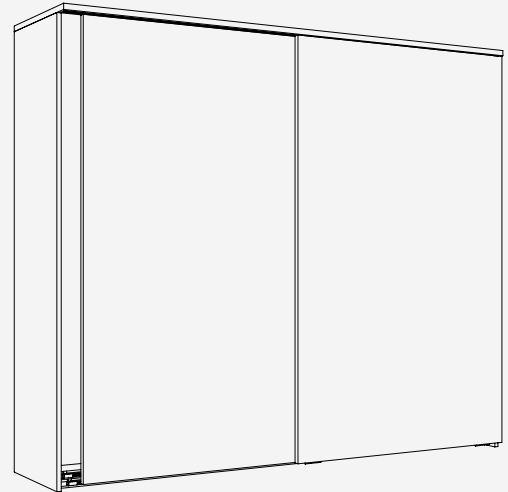
Max. 2400 mm (7'10 7/16")



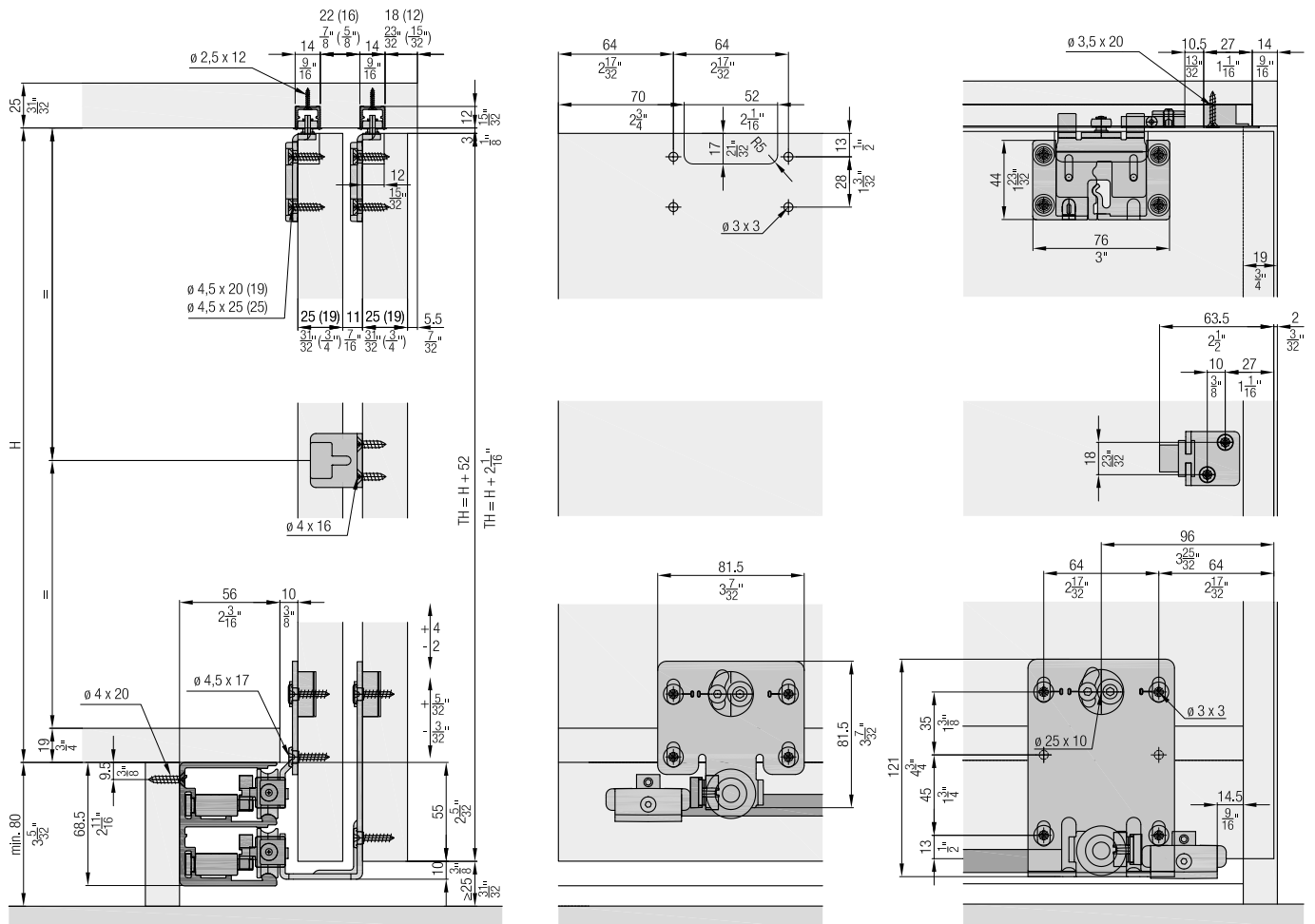
Max. 1400 mm (4'7 1/8")



19/25 mm (3/4" or 31/32")



















Installation examples



Set for 2 or 3 wooden doors, 19 mm (3/4")

	No.
Hawa Combino 50 H MS, door thickness 19 mm (3/4"), for 2 doors	055.3199.071
Hawa Combino 50 H MS, door thickness 19 mm (3/4"), for 3 doors	055.3199.073

















Set consisting of:

		055.3199.071	055.3199.073	No.
	Running gear, interior door, steel, zinc-plated	2	4	055.3169.071
	Running gear, exterior door, 19 mm (3/4"), steel, zinc-plated	2	2	055.3113.175
	Guide bracket, steel, zinc-plated	4	6	055.3059.171
	Guide bracket housing, plastic, anthracite	4	6	055.0282.001
	Anti-derailment device, plastic, red	4	6	055.0186.001
	Stopper, plastic, gray	4	4	055.3167.071
	Retention spring for stopper, plastic, gray	2	3	055.0204.001
	Stopper guide, plastic, gray	4	4	040.3079.074
	Door follower, with 2 doors, steel, zinc-plated	1		055.3124.071
	Track end piece, plastic, gray, 31 mm (1 7/32")	3	4	040.3083.002
	Track end piece, plastic, gray, 22 mm (7/8")	1		040.3083.003
	Washer and screw assembly, 4.5x17 mm, steel, zinc-plated	16	24	055.0100.101
	Countersunk head screw, 4.5x20 mm, steel, zinc-plated	16	24	600.0000.167
	Countersunk head screw, 3.5x20 mm, steel, zinc-plated	4	4	766.5035.120
	Door follower, with 3 doors, 2-piece set, steel, zinc-plated		1	056.3095.171
	Buffer, with adhesive, 2-piece set		1	053.3364.051

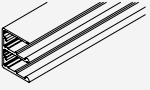
Set for 2 or 3 wooden doors, 25 mm (31/32")

	No.
Hawa Combino 50 H MS, door thickness 25 mm (31/32"), for 2 doors	055.3199.072
Hawa Combino 50 H MS, door thickness 25 mm (31/32"), for 3 doors	055.3199.074


Set consisting of:

		055.3199.072	055.3199.074	No.
	Running gear, interior door, steel, zinc-plated	2	4	055.3169.071
	Running gear, exterior door, 25 mm (31/32"), steel, zinc-plated	2	2	055.3114.175
	Guide bracket, steel, zinc-plated	4	6	055.3059.171
	Guide bracket housing, plastic, anthracite	4	6	055.0282.001
	Anti-derailment device, plastic, red	4	6	055.0186.001
	Stopper, plastic, gray	4	4	055.3167.071
	Retention spring for stopper, plastic, gray	2	3	055.0204.001
	Stopper guide, plastic, gray	4	4	040.3079.074
	Door follower, with 2 doors, steel, zinc-plated	1		055.3124.071
	Track end piece, plastic, gray, 31 mm (1 7/32")	3	4	040.3083.002
	Track end piece, plastic, gray, 22 mm (7/8")	1		040.3083.003
	Washer and screw assembly, 4.5x17 mm, steel, zinc-plated	16	24	055.0100.101
	Countersunk head screw, 4.5x25 mm, steel, zinc-plated	16	24	766.5045.125
	Countersunk head screw, 3.5x20 mm, steel, zinc-plated	4	4	766.5035.120
	Door follower, with 3 doors, 2-piece set, steel, zinc-plated		1	056.3095.171
	Buffer, with adhesive, 2-piece set		1	053.3364.051

Running tracks


		mm (inch)	No.
	Double running track, aluminum, anodized, pre-drilled, for soft close	2500 (8'2 7/16")	055.3160.250
		3500 (11'5 25/32")	055.3160.350
		6000 (19'8 7/32")	055.3160.600

Guide tracks

		mm (inch)	No.
	Guide track, aluminum, pre-drilled	2500 (8'2 7/16")	056.3079.250
		3500 (11'5 25/32")	056.3079.350
		6000 (19'8 7/32")	056.3079.600

Stopper extension






For use without soft close order 4 pieces

		No.
	Stopper extension, plastic, gray	055.3168.071


Soft close

	No.
Hawa Combino 50 H MS/FS, up to 50 kg (110 lbs.), 2 pieces	055.3215.071
Hawa Combino 50 H MS/FS, up to 50 kg (110 lbs.), 4 pieces	055.3215.072

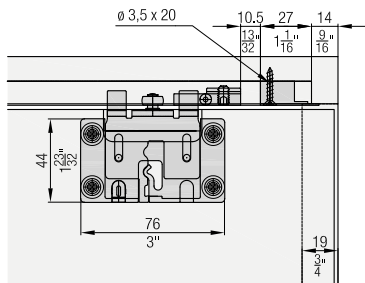
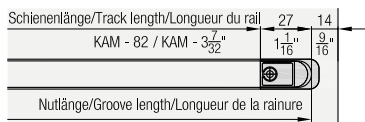
Set consisting of:

		055.3215.071	055.3215.072	No.
	Soft close, left, up to 50 kg (110 lbs.)	1	2	055.3166.072
	Soft close, right, up to 50 kg (110 lbs.)	1	2	055.3166.071
	Activator soft close	2	4	055.3165.071
	Stopper extension, plastic, gray	2		055.3168.071
	Thread-cutting head screw, M4x8 mm, steel, zinc-plated	2	4	600.0000.344

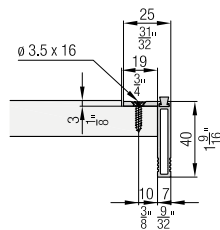
Accessories

	No.	
	Drilling and milling jig, for processing guide brackets, wood	055.3099.001

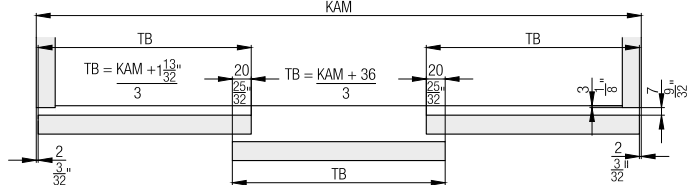
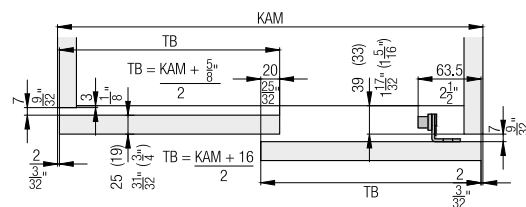
Track end piece



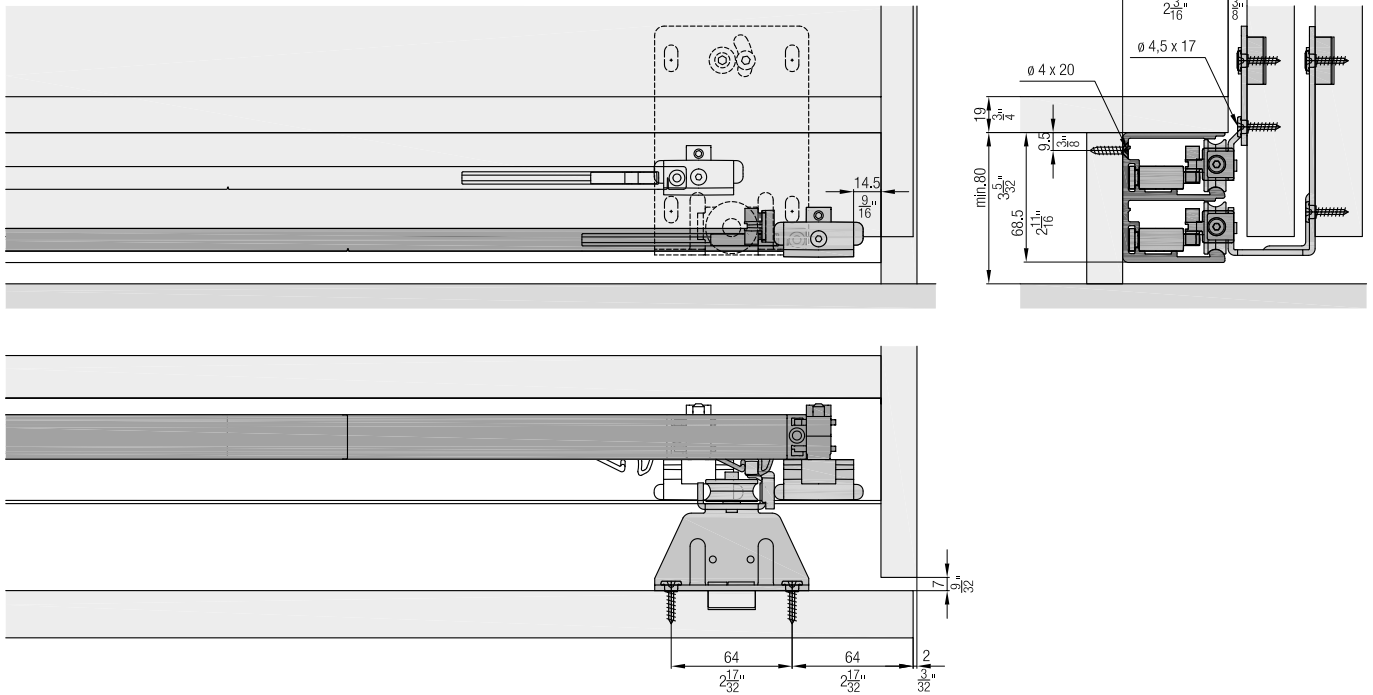
Handle profiles



Calculations



Soft close



Accessories



- Straightening fitting from page 236
- Handle profiles from page 238
- Order overview soft close from page 240

Planning/execution



Further information about the product can be found on www.hawa.com.

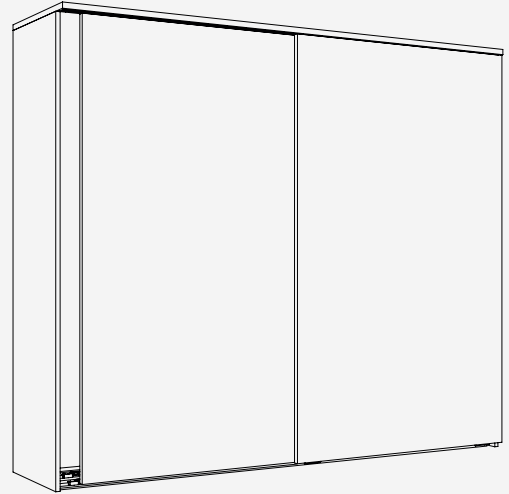
Fitting for 2–3 bottom-running wooden doors (19/25 mm) up to 50 kg (110 lbs.) with screwed on running track. Design Mixslide without soft close

Product highlights

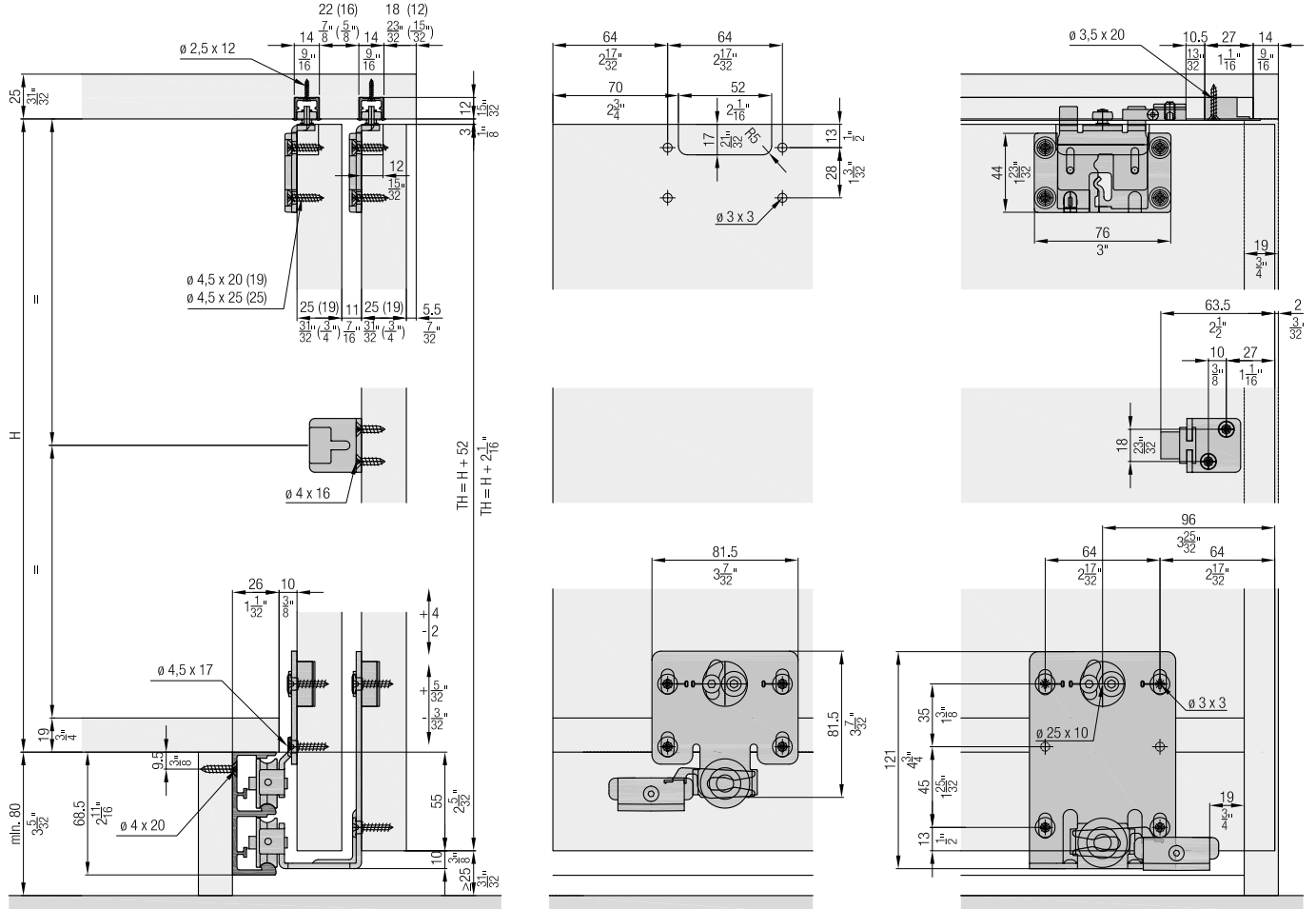
-  **Aesthetics** Bottom-running system that supports the entire door weight on the base makes cabinet designs with thin materials possible
-  **Comfort** Smooth, silent running with Hawa Comfort roller

Technical specifications

-  Max. 50 kg (110 lbs.)
-  Max. 2400 mm (7'10 7/16")
-  Max. 1400 mm (4'7 1/8")
-  19/25 mm (3/4" or 31/32")






Installation examples



Set for 2 or 3 wooden doors, 19 mm (3/4")

	No.
Hawa Combino 50 H MS, door thickness 19 mm (3/4"), for 2 doors	055.3199.071
Hawa Combino 50 H MS, door thickness 19 mm (3/4"), for 3 doors	055.3199.073

















Set consisting of:

		055.3199.071	055.3199.073	No.
	Running gear, interior door, steel, zinc-plated	2	4	055.3169.071
	Running gear, exterior door, 19 mm (3/4"), steel, zinc-plated	2	2	055.3113.175
	Guide bracket, steel, zinc-plated	4	6	055.3059.171
	Guide bracket housing, plastic, anthracite	4	6	055.0282.001
	Anti-derailment device, plastic, red	4	6	055.0186.001
	Stopper, plastic, gray	4	4	055.3167.071
	Retention spring for stopper, plastic, gray	2	3	055.0204.001
	Stopper guide, plastic, gray	4	4	040.3079.074
	Door follower, with 2 doors, steel, zinc-plated	1		055.3124.071
	Track end piece, plastic, gray, 31 mm (1 7/32")	3	4	040.3083.002
	Track end piece, plastic, gray, 22 mm (7/8")	1		040.3083.003
	Washer-and-screw assembly, 4.5x17 mm, steel, zinc-plated	16	24	055.0100.101
	Countersunk head screw, 4.5x20 mm, steel, zinc-plated	16	24	600.0000.167
	Countersunk head screw, 3.5x20 mm, steel, zinc-plated	4	4	766.5035.120
	Door follower, with 3 doors, 2-piece set, steel, zinc-plated		1	056.3095.171
	Buffer, with adhesive, 2-piece set		1	053.3364.051

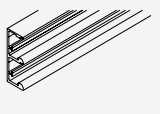
Set for 2 or 3 wooden doors, 25 mm (31/32")

	No.
Hawa Combino 50 H MS, door thickness 25 mm (31/32"), for 2 doors	055.3199.072
Hawa Combino 50 H MS, door thickness 25 mm (31/32"), for 3 doors	055.3199.074

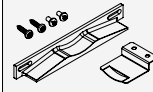

Set consisting of:

		055.3199.072	055.3199.074	No.
	Running gear, interior door, steel, zinc-plated	2	4	055.3169.071
	Running gear, exterior door, 25 mm (31/32"), steel, zinc-plated	2	2	055.3114.175
	Guide bracket, steel, zinc-plated	4	6	055.3059.171
	Guide bracket housing, plastic, anthracite	4	6	055.0282.001
	Anti-derailment device, plastic, red	4	6	055.0186.001
	Stopper, plastic, gray	4	4	055.3167.071
	Retention spring for stopper, plastic, gray	2	3	055.0204.001
	Stopper guide, plastic, gray	4	4	040.3079.074
	Door follower, with 2 doors, steel, zinc-plated	1		055.3124.071
	Track end piece, plastic, gray, 31 mm (1 7/32")	3	4	040.3083.002
	Track end piece, plastic, gray, 22 mm (7/8")	1		040.3083.003
	Washer-and-screw assembly, 4.5x17 mm, steel, zinc-plated	16	24	055.0100.101
	Countersunk head screw, 4.5x25 mm, steel, zinc-plated	16	24	766.5045.125
	Countersunk head screw, 3.5x20 mm, steel, zinc-plated	4	4	766.5035.120
	Door follower, with 3 doors, 2-piece set, steel, zinc-plated		1	056.3095.171
	Buffer, with adhesive, 2-piece set		1	053.3364.051


Running tracks

		mm (inch)	No.
	Double running track, aluminum, anodized, pre-drilled	2500 (8'2 7/16")	055.3161.250
		3500 (11'5 25/32")	055.3161.350
		6000 (19'8 7/32")	055.3161.600

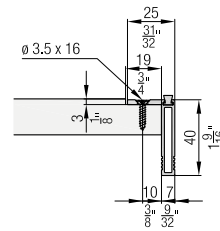
Accessories

		No.
	Intermediate stop set, for 3 doors	055.3218.071
	Drilling and milling jig, for processing guide brackets, wood	055.3099.001

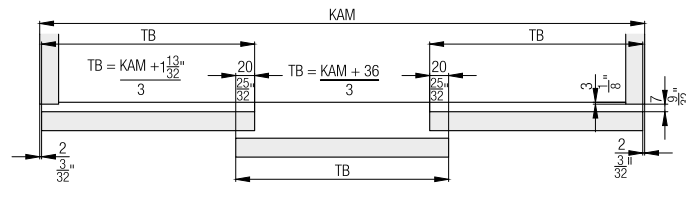
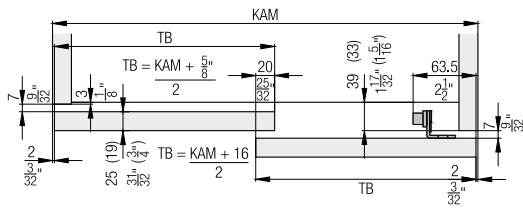
Guide tracks

		mm (inch)	No.
	Guide track, aluminum, pre-drilled	2500 (8'2 7/16")	056.3079.250
		3500 (11'5 25/32")	056.3079.350
		6000 (19'8 7/32")	056.3079.600

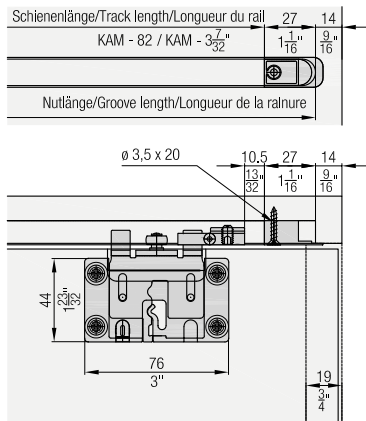
Handle profiles



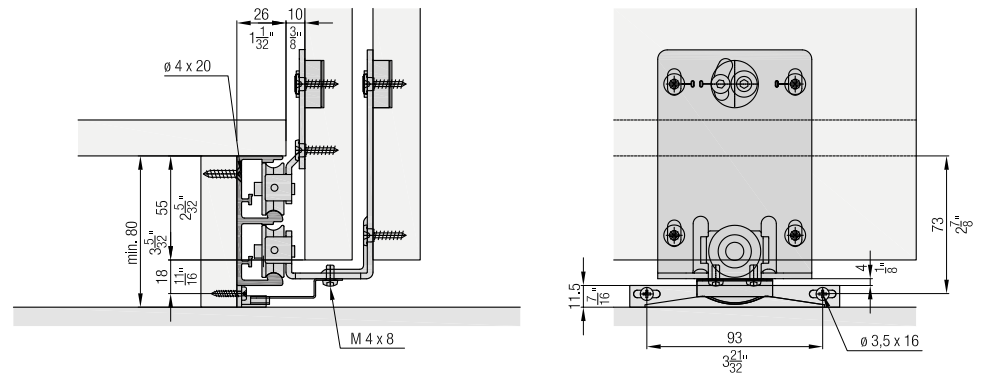
Calculations



Track end piece



Intermediate stop with 3 doors



Accessories



- Straightening fitting from page 236
- Handle profiles from page 238

Planning/execution





Further information about the product can be found on www.hawa.com.

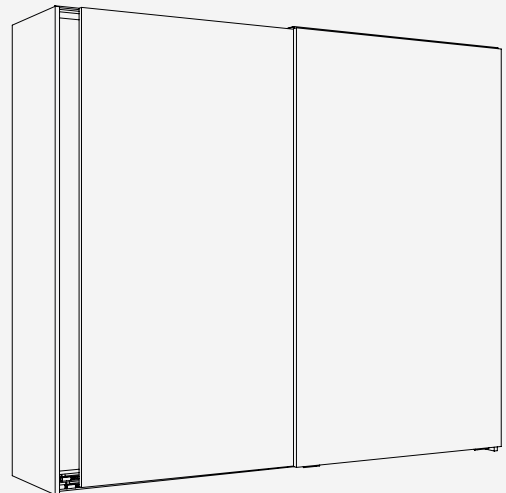
Fitting for 2–3 bottom-running wooden doors (19/25 mm) up to 50 kg (110 lbs.) with screwed on running track and integrated soft close. Design Forslide.

Product highlights

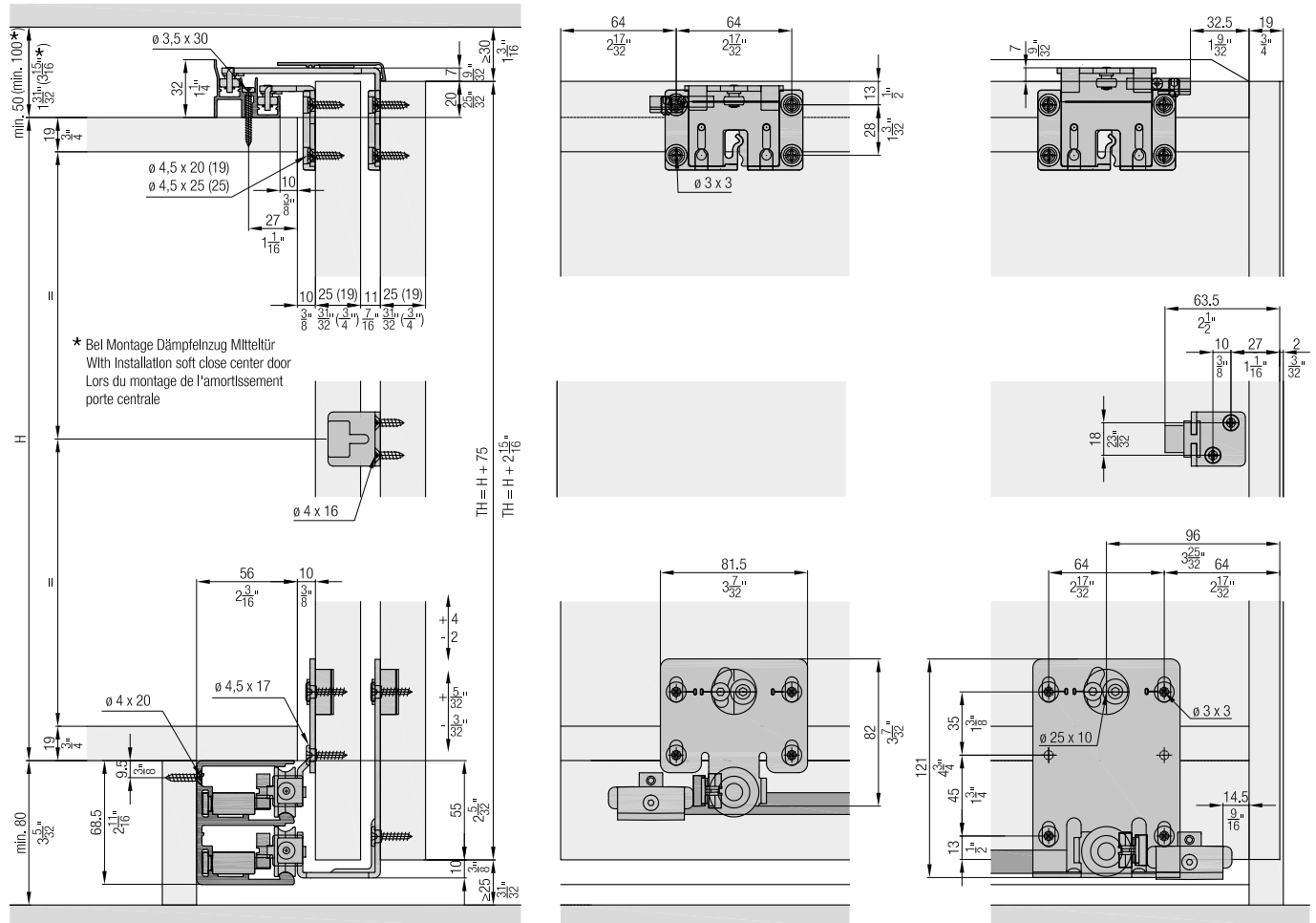
-  **Comfort** Sophisticated soft closing system and innovation arrangement of the components for very easy operation
-  **Aesthetics** Bottom-running system that supports the entire door weight on the base makes cabinet designs with thin materials possible

Technical specifications

-  **Max.** 50 kg (110 lbs.)
-  **Max.** 2400 mm (7'10 7/16")
-  **Max.** 1400 mm (4'7 1/8")
-  **19/25 mm (3/4" or 31/32")**



Installation examples



Set for 2 or 3 wooden doors, 19 mm (3/4")

	No.
Hawa Combino 50 H FS, door thickness 19 mm (3/4"), for 2 doors	055.3200.071
Hawa Combino 50 H FS, door thickness 19 mm (3/4"), for 3 doors	055.3200.073

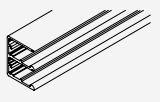
Set consisting of:	055.3200.071		055.3200.073		No.
 Running gear, interior door, steel, zinc-plated	2	4			055.3169.071
 Running gear, exterior door, 19 mm (3/4"), steel, zinc-plated	2	2			055.3113.175
 Guide bracket, interior door, steel, zinc-plated	2	4			055.3107.171
 Guide bracket, exterior door, 19 mm (3/4"), steel, zinc-plated	2	2			055.3109.171
 Guide bracket housing, plastic, anthracite	4	6			055.0282.001
 Stopper, plastic, gray	4	4			055.3167.071
 Retention spring for stopper, plastic, gray	2	3			055.0204.001
 Stopper guide, plastic, gray	4	4			040.3079.074
 Door follower, with 2 doors, steel, zinc-plated	1				055.3124.071
 Washer and screw assembly, 4.5x17 mm, steel, zinc-plated	16	24			055.0100.101
 Countersunk head screw, 4.5x20 mm, steel, zinc-plated	16	24			600.0000.167
 Door follower, with 3 doors, steel, zinc-plated			2		055.3126.171
 Buffer, with adhesive, 2-piece set			1		053.3364.051
 Thread-cutting rounded head screw, M4x8 mm, steel, zinc-plated			2		600.0000.328

Set for 2 or 3 wooden doors, 25 mm (31/32")

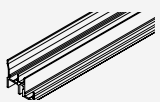
	No.
Hawa Combino 50 H FS, door thickness 25 mm (31/32"), for 2 doors	055.3200.072
Hawa Combino 50 H FS, door thickness 25 mm (31/32"), for 3 doors	055.3200.074

Set consisting of:	055.3200.072		055.3200.074		No.
 Running gear, interior door, steel, zinc-plated	2	4			055.3169.071
 Running gear, exterior door, 25 mm (31/32"), steel, zinc-plated	2	2			055.3114.175
 Guide bracket, interior door, steel, zinc-plated	2	4			055.3107.171
 Guide bracket, exterior door, 25 mm (31/32"), steel, zinc-plated	2	2			055.3110.171
 Guide bracket housing, plastic, anthracite	4	6			055.0282.001
 Stopper, plastic, gray	4	4			055.3167.071
 Retention spring for stopper, plastic, gray	2	3			055.0204.001
 Stopper guide, plastic, gray	4	4			040.3079.074
 Door follower, with 2 doors, steel, zinc-plated	1				055.3124.071
 Washer and screw assembly, 4.5x17 mm, steel, zinc-plated	16	24			055.0100.101
 Countersunk head screw, 4.5x25 mm, steel, zinc-plated	16	24			766.5045.125
 Door follower, with 3 doors, steel, zinc-plated			2		055.3126.171
 Buffer, with adhesive, 2-piece set			1		053.3364.051
 Thread-cutting rounded head screw, M4x8 mm, steel, zinc-plated			2		600.0000.328


Running tracks

		mm (inch)	No.
	Double running track, aluminum, anodized, pre-drilled, for soft close	2500 (8'2 7/16")	055.3160.250
		3500 (11'5 25/32")	055.3160.350
		6000 (19'8 7/32")	055.3160.600

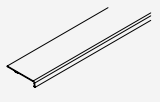
Guide tracks

		mm (inch)	No.
	Double guide track, aluminum, anodized, pre-drilled	2500 (8'2 7/16")	056.3072.250
		3500 (11'5 25/32")	056.3072.350
		6000 (19'8 7/32")	056.3072.600

Stopper extension
For use without soft close order 4 pieces

		No.
	Stopper extension, plastic, gray	055.3168.071






Panels

		mm (inch)	No.
	Cover panel, aluminum, anodized	2500 (8'2 7/16")	055.3130.250
		3500 (11'5 25/32")	055.3130.350
		6000 (19'8 7/32")	055.3130.600

Soft close

		No.
Hawa Combino 50 H MS/FS, up to 50 kg (110 lbs.), 2 pieces		055.3215.071
Hawa Combino 50 H MS/FS, up to 50 kg (110 lbs.), 4 pieces		055.3215.072

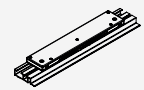
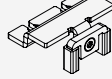




Set consisting of:

		055.3215.071	055.3215.072	No.
	Soft close, left, up to 50 kg (110 lbs.)	1	2	055.3166.072
	Soft close, right, up to 50 kg (110 lbs.)	1	2	055.3166.071
	Activator soft close	2	4	055.3165.071
	Stopper extension, plastic, gray	2		055.3168.071
	Thread-cutting head screw, M4x8 mm, steel, zinc-plated	2	4	600.0000.344

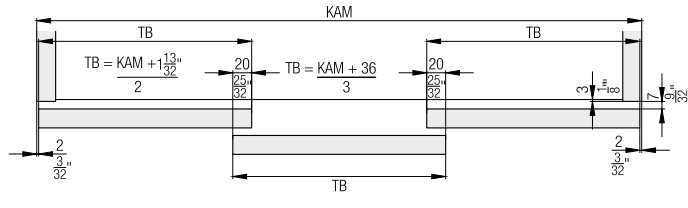
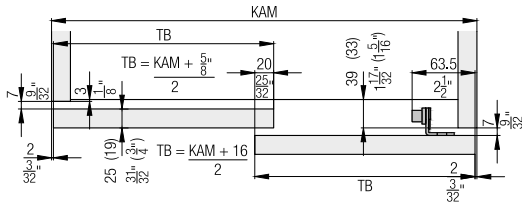
Soft close center door

		No.
Hawa Combino 50 H FS, center door		055.3216.071

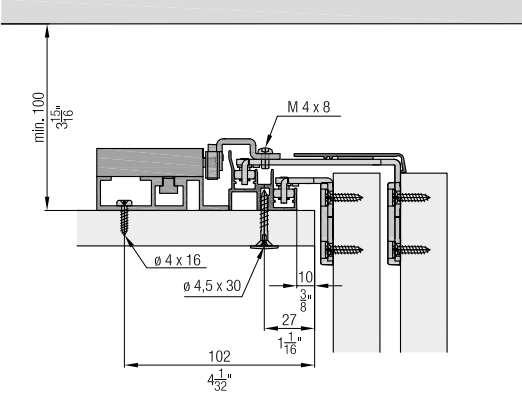
Set consisting of:

		055.3216.071	No.
	Soft close, center door	1	055.3193.071
	Activator, center door soft close	1	055.3195.071
	Safety device for guide bracket, plastic, anthracite	1	053.3099.001
	Rubber buffer, plastic, transparent	2	055.0318.001
	Fillister head screw, 4x16 mm, steel, zinc-plated	2	600.0000.166
	Countersunk head screw, 4.5x20 mm, steel, zinc-plated	1	600.0000.167
	Thread-cutting rounded head screw, M4x8 mm, steel, zinc-plated	2	762.7009.100

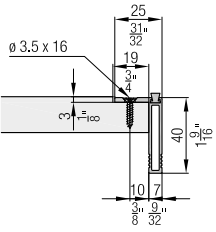
Calculations



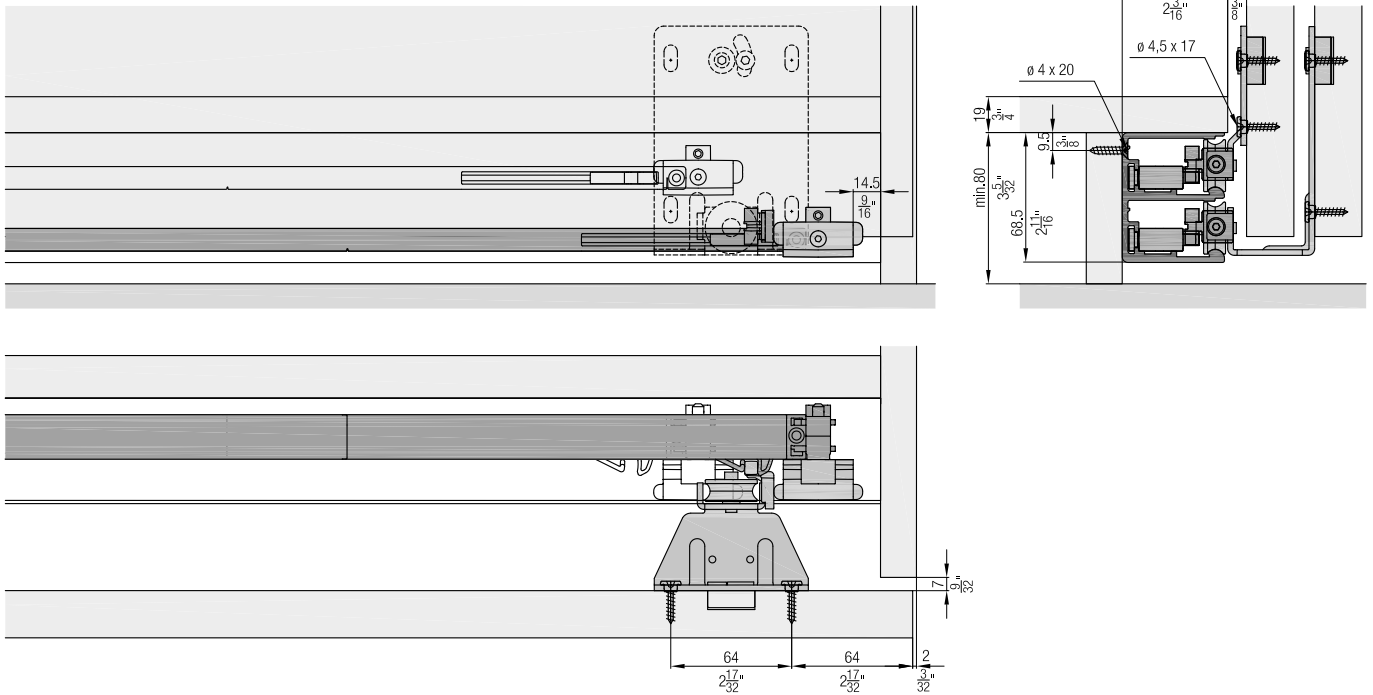
Center door soft close for 3 doors



Handle profiles



Soft close



Accessories



- Straightening fitting from page 236
- Handle profiles from page 238
- Order overview soft close from page 240

Planning/execution

Further information about the product can be found on www.hawa.com.

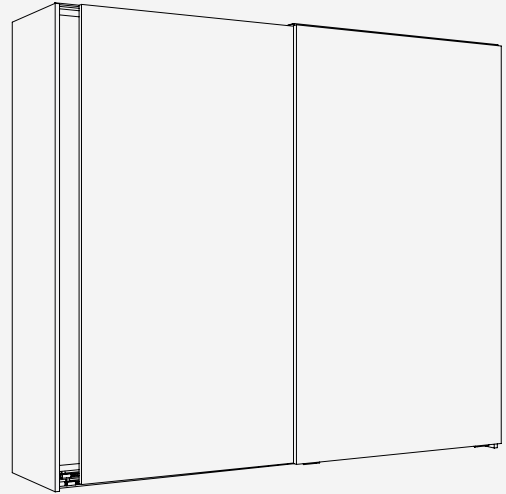
Fitting for 2–3 bottom-running wooden doors (19/25 mm) up to 50 kg (110 lbs.) with screwed on running track. Design Forslide without soft close

Product highlights

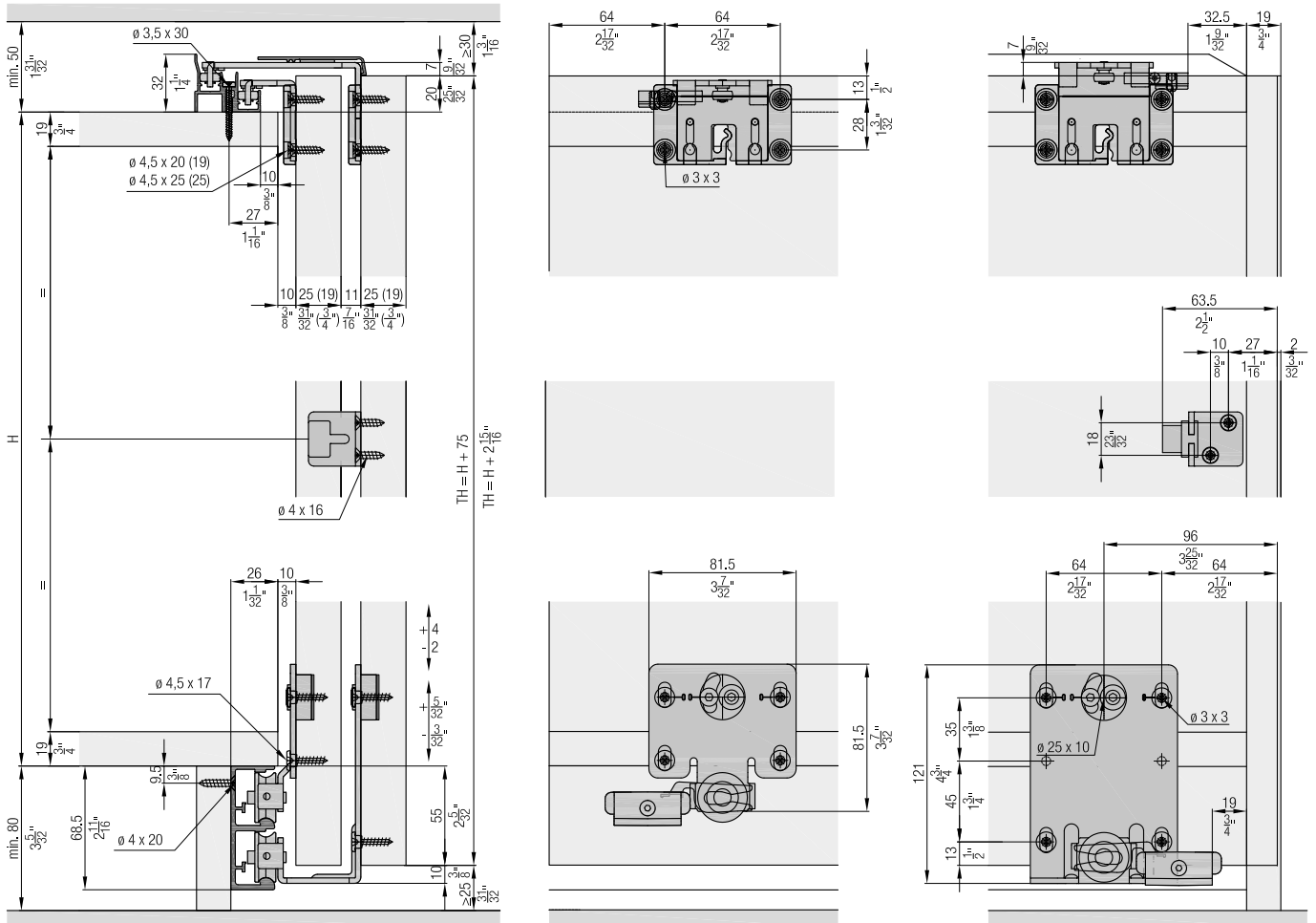
-  **Aesthetics** Bottom-running system that supports the entire door weight on the base makes cabinet designs with thin materials possible
-  **Comfort** Smooth, silent running with Hawa Comfort roller

Technical specifications

-  Max. 50 kg (110 lbs.)
-  Max. 2400 mm (7'10 7/16")
-  Max. 1400 mm (4'7 1/8")
-  19/25 mm (3/4" or 31/32")



Installation examples











Set for 2 or 3 wooden doors, 19 mm (3/4")

	No.
Hawa Combino 50 H FS, door thickness 19 mm (3/4"), for 2 doors	055.3200.071
Hawa Combino 50 H FS, door thickness 19 mm (3/4"), for 3 doors	055.3200.073

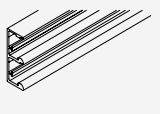
Set consisting of:	055.3200.071		055.3200.073		No.
 Running gear, interior door, steel, zinc-plated	2	4			055.3169.071
 Running gear, exterior door, 19 mm (3/4"), steel, zinc-plated	2	2			055.3113.175
 Guide bracket, interior door, steel, zinc-plated	2	4			055.3107.171
 Guide bracket, exterior door, 19 mm (3/4"), steel, zinc-plated	2	2			055.3109.171
 Guide bracket housing, plastic, anthracite	4	6			055.0282.001
 Stopper, plastic, gray	4	4			055.3167.071
 Retention spring for stopper, plastic, gray	2	3			055.0204.001
 Stopper guide, plastic, gray	4	4			040.3079.074
 Door follower, with 2 doors, steel, zinc-plated	1				055.3124.071
 Washer and screw assembly, 4.5x17 mm, steel, zinc-plated	16	24			055.0100.101
 Countersunk head screw, 4.5x20 mm, steel, zinc-plated	16	24			600.0000.167
 Door follower, with 3 doors, steel, zinc-plated			2		055.3126.171
 Buffer, with adhesive, 2-piece set			1		053.3364.051
 Thread-cutting rounded head screw, M4x8 mm, steel, zinc-plated			2		600.0000.328

Set for 2 or 3 wooden doors, 25 mm (31/32")

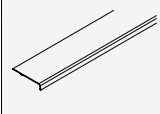
	No.
Hawa Combino 50 H FS, door thickness 25 mm (31/32"), for 2 doors	055.3200.072
Hawa Combino 50 H FS, door thickness 25 mm (31/32"), for 3 doors	055.3200.074

Set consisting of:	055.3200.072		055.3200.074		No.
 Running gear, interior door, steel, zinc-plated	2	4			055.3169.071
 Running gear, exterior door, 25 mm (31/32"), steel, zinc-plated	2	2			055.3114.175
 Guide bracket, interior door, steel, zinc-plated	2	4			055.3107.171
 Guide bracket, exterior door, 25 mm (31/32"), steel, zinc-plated	2	2			055.3110.171
 Guide bracket housing, plastic, anthracite	4	6			055.0282.001
 Stopper, plastic, gray	4	4			055.3167.071
 Retention spring for stopper, plastic, gray	2	3			055.0204.001
 Stopper guide, plastic, gray	4	4			040.3079.074
 Door follower, with 2 doors, steel, zinc-plated	1				055.3124.071
 Washer and screw assembly, 4.5x17 mm, steel, zinc-plated	16	24			055.0100.101
 Countersunk head screw, 4.5x25 mm, steel, zinc-plated	16	24			766.5045.125
 Door follower, with 3 doors, steel, zinc-plated			2		055.3126.171
 Buffer, with adhesive, 2-piece set			1		053.3364.051
 Thread-cutting rounded head screw, M4x8 mm, steel, zinc-plated			2		600.0000.328

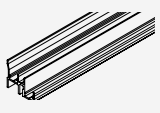
Running tracks

		mm (inch)	No.
	Double running track, aluminum, anodized, pre-drilled	2500 (8'2 7/16")	055.3161.250
		3500 (11'5 25/32")	055.3161.350
		6000 (19'8 7/32")	055.3161.600

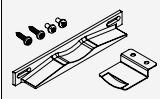
Panels

		mm (inch)	No.
	Cover panel, aluminum, anodized	2500 (8'2 7/16")	055.3130.250
		3500 (11'5 25/32")	055.3130.350
		6000 (19'8 7/32")	055.3130.600

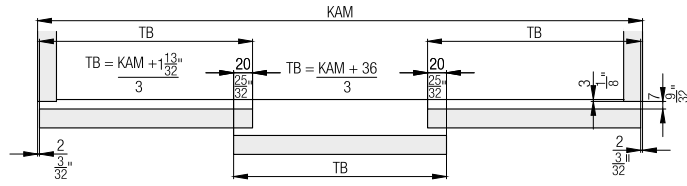
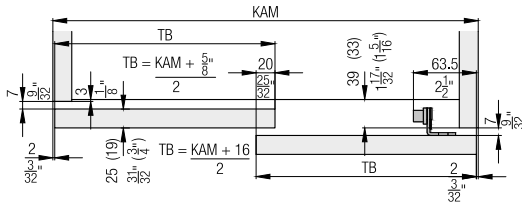
Guide tracks

		mm (inch)	No.
	Double guide track, aluminum, anodized, pre-drilled	2500 (8'2 7/16")	056.3072.250
		3500 (11'5 25/32")	056.3072.350
		6000 (19'8 7/32")	056.3072.600

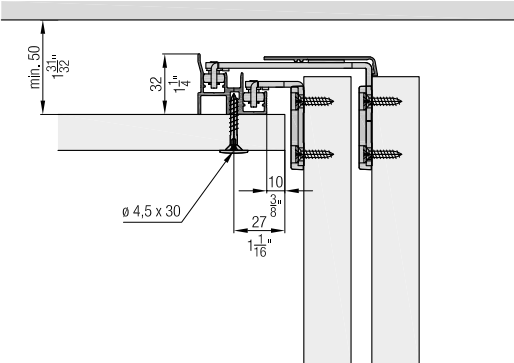
Accessories

		No.
	Intermediate stop set, for 3 doors	055.3218.071

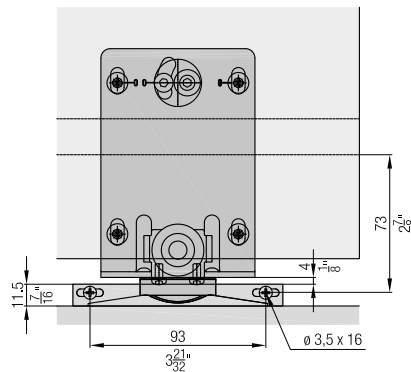
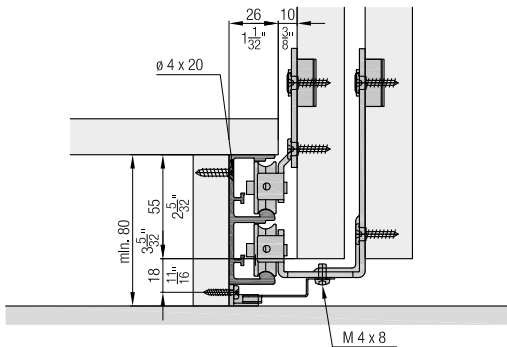
Calculations



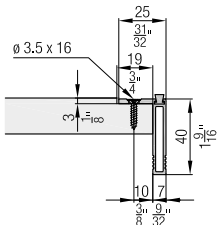
Optional: Guide track installation from below



Intermediate stop with 3 doors



Handle profiles



Accessories



- Straightening fitting from page 236
- Handle profiles from page 238

Planning/execution





Further information about the product can be found on www.hawa.com.

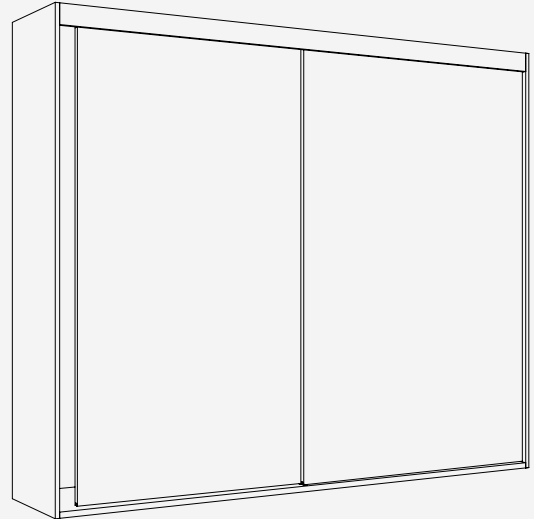
Fitting for 2–3 top-running wooden doors up to 65 kg (143 lbs.) with screwed on running track. Optional soft close integrated in track. Design Inside top-running

Product highlights

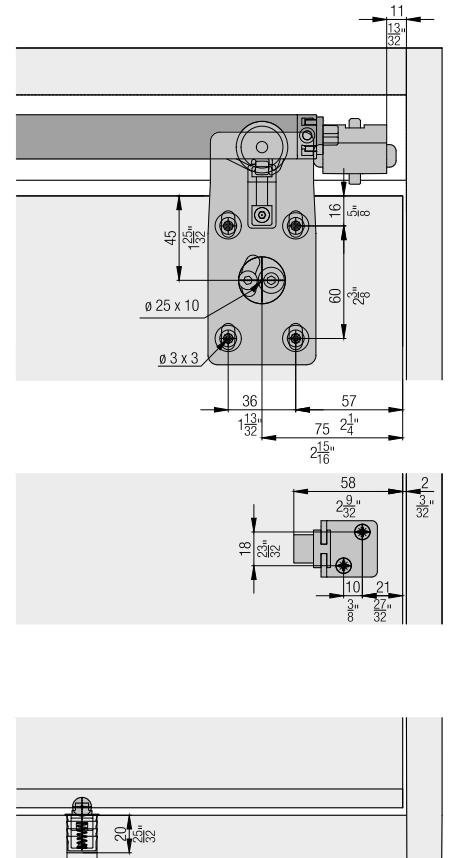
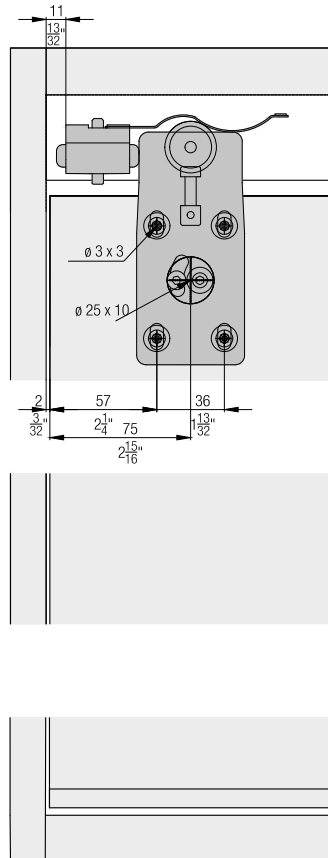
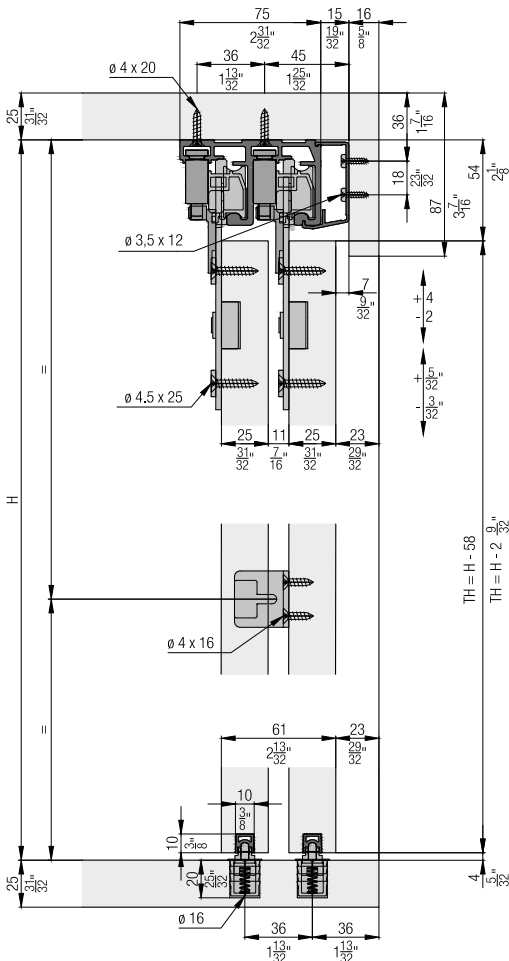
-  **Comfort** Smooth, silent running with Hawa Comfort roller
-  **Comfort** Sophisticated soft closing system and innovation arrangement of the components for very easy operation

Technical specifications

-  Max. 65 kg (143 lbs.)
-  Max. 2600 mm (8'6 3/8")
-  Max. 1400 mm (4'7 1/8")
-  Min. 25–40 mm (31/32" to 1 9/16")












Installation examples



Set for 2 or 3 wooden doors

	Nr.
Hawa Combino 65 H IS, door thickness 25–40 mm (31/32"-1 9/16"), for 2 doors	055.3202.071
Hawa Combino 65 H IS, door thickness 25–40 mm (31/32"-1 9/16"), max. door width 1350 mm (4'5 5/32"), for 3 doors	055.3202.072

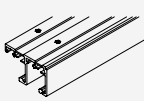
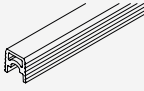
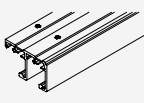
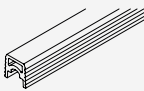
Set consisting of:

	055.3202.071	055.3202.072	Nr.
 Running gear, steel, zinc-plated	4	6	055.3152.071
 Bottom guide, plastic, gray	2	3	055.3081.071
 Stopper, plastic, gray	4	4	055.3153.071
 Retention spring for stopper, steel	2	3	055.3190.071
 Door follower, with 2 doors, steel, zinc-plated	1		055.3124.071
 Centering disk, plastic, white	16	24	055.0110.001
 Countersunk head screw, 4.5x25 mm, steel, zinc-plated	16	24	766.5045.125
 Thread-cutting rounded head screw, M4x8 mm, steel, zinc-plated	2	3	762.7009.100
 Buffer, with adhesive, 2-piece set	1		053.3364.051

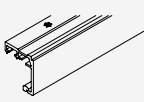
Track sets, 25 mm (31/32")

	Nr.
Hawa Combino 65 H IS, 2500 mm (8'2 7/16")	055.3208.071
Hawa Combino 65 H IS, 4000 mm (13'1 15/32")	055.3208.072

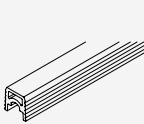
Set consisting of:

	mm (inch)	055.3208.071	055.3208.072	Nr.
 Double running track, aluminum, anodized, pre-drilled	2500 (8'2 7/16")	1		055.3143.250
 Guide track, plastic, gray, for glue fixing	2500 (8'2 7/16")	1		055.3171.250
 Double running track, aluminum, anodized, pre-drilled	4000 (13'1 15/32")		1	055.3143.400
 Guide track, plastic, gray, for glue fixing	1450 (4'9 3/32")		3	055.3171.145

Running tracks, from a door thickness of 28 mm (1 3/32")

	mm (inch)	Nr.
 Single running track, aluminum, anodized, pre-drilled	2500 (8'2 7/16")	055.3162.250
	4000 (13'1 15/32")	055.3162.400

Guide tracks





	mm (inch)	Nr.
 Guide track, plastic, gray, for glue fixing	2500 (8'2 7/16")	055.3171.250
	3500 (11'5 25/32")	055.3171.350
	6000 (19'8 7/32")	055.3171.600

Soft close
For soft closing in opening and closing direction
order 2 sets.

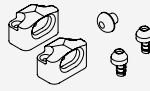

	Nr.
EKU Combino 65 H IS/MS, up to 65 kg (143 lbs.), 2 pieces	055.3214.071

	Nr.
	055.3214.071

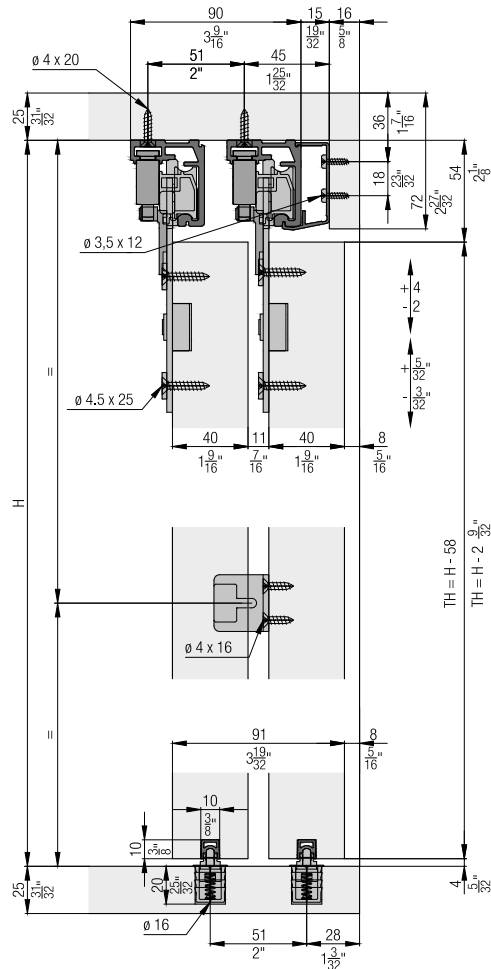
Set consisting of:

	Soft close, right, up to 65 kg (143 lbs.)	1	055.3149.071
	Soft close, left, up to 65 kg (143 lbs.)	1	055.3149.072
	Activator, for soft close	2	055.3156.071
	Thread-cutting head screw, M4x8 mm, steel, zinc-plated	2	600.0000.344

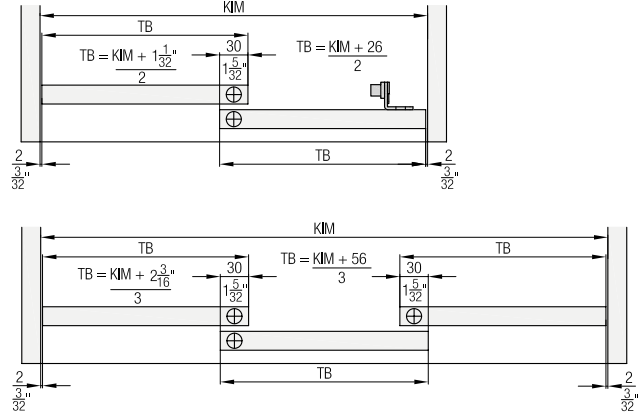
Accessories

	Nr.	
	Door centering, for 2 doors, plastic, anthracite	053.3207.071
	Clip-on component, for wooden panel, every 700–800 mm (2'3 9/16"–2'7 1/2"), aluminum, pre-drilled	055.3155.000

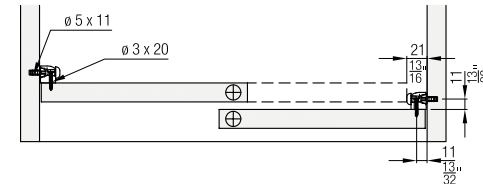
Door 40 mm (1 9/16")



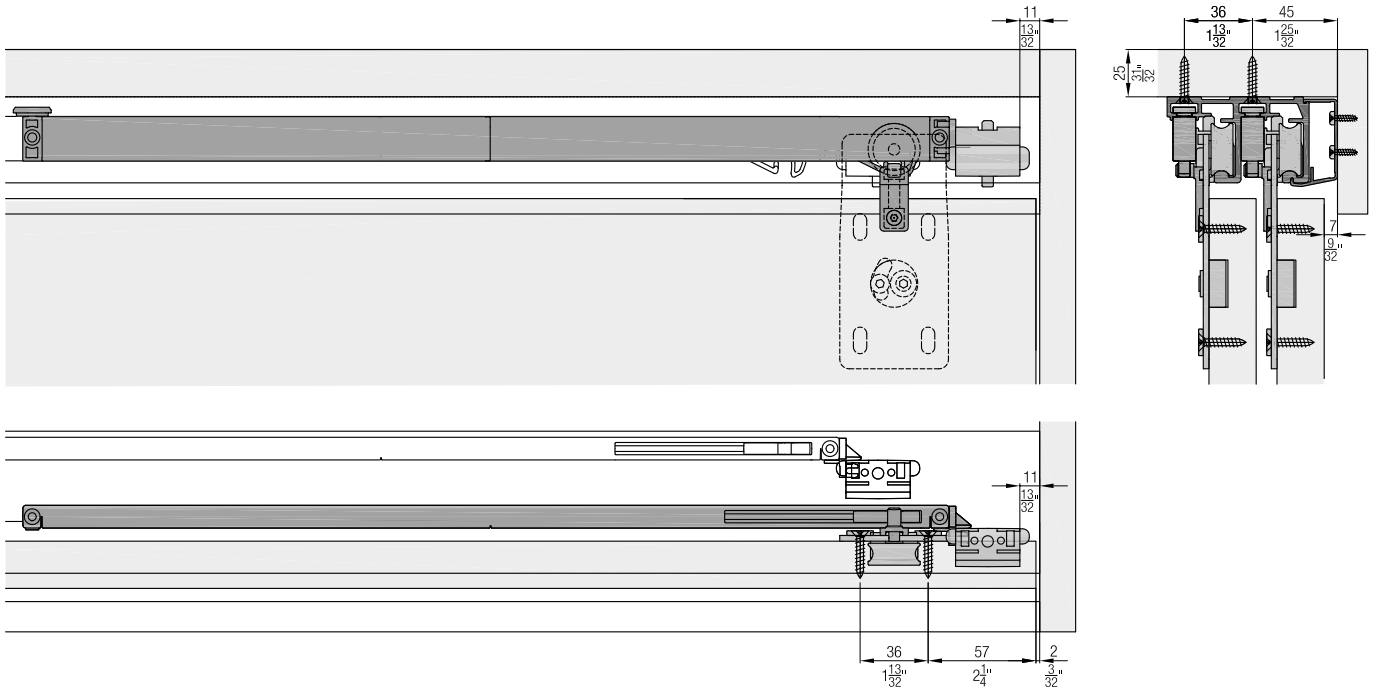
Calculations



Door centering



Soft close



Accessories



- Straightening fitting from page 236
- Order overview soft close from page 240

Planning/execution




Further information about the product can be found on www.hawa.com.

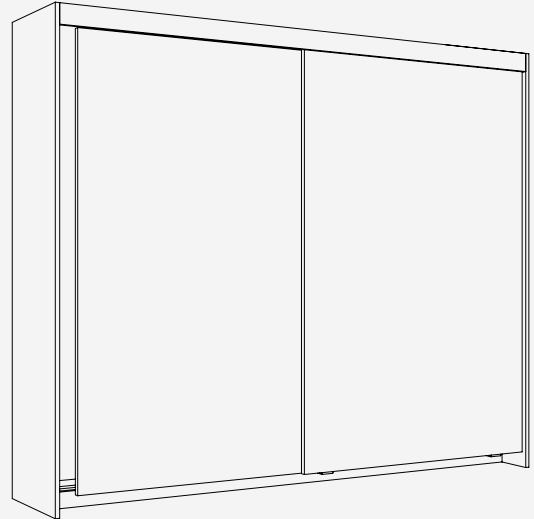
Fitting for 2–3 top-running wooden doors up to 65 kg (143 lbs.) with screwed on running track. Optional soft close integrated in track. Design Mixslide top-running.

Product highlights

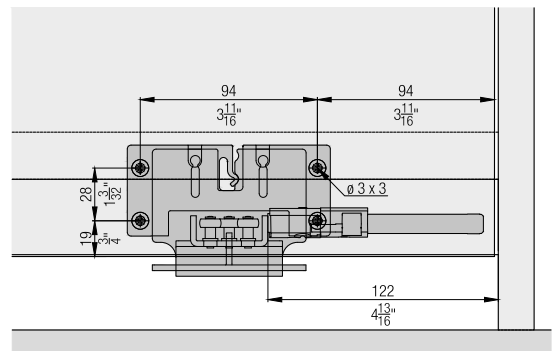
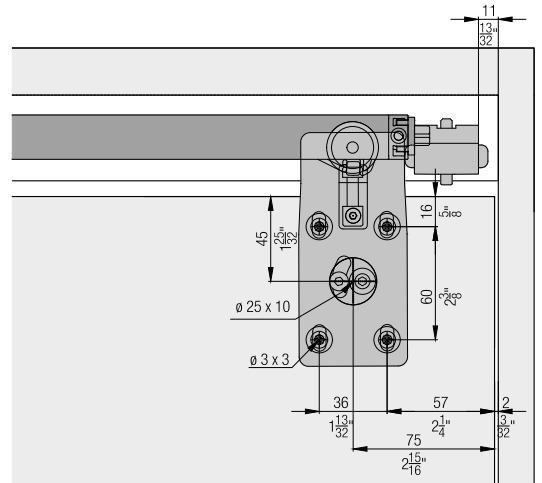
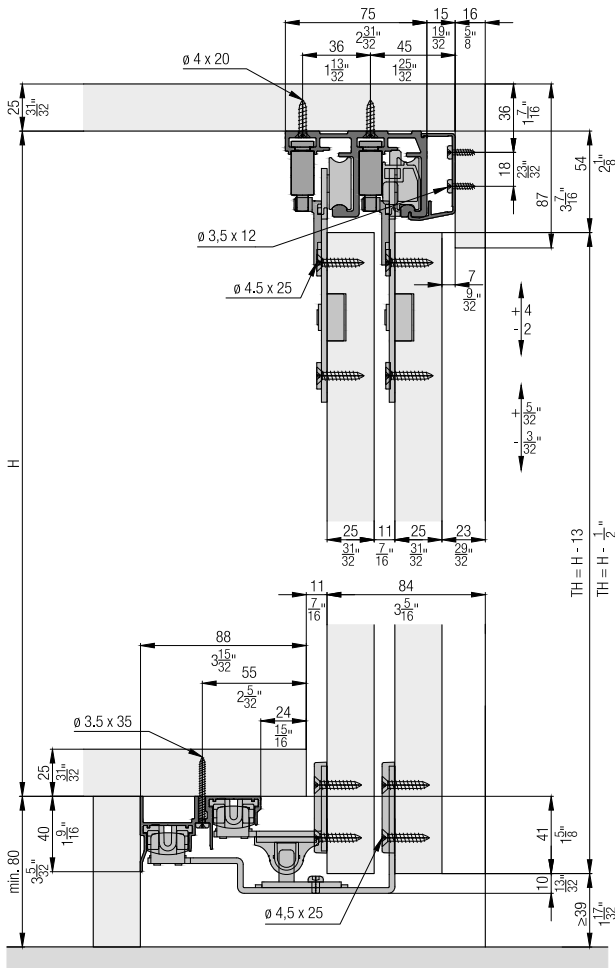
-  **Comfort** Smooth, silent running with Hawa Comfort roller
-  **Comfort** Sophisticated soft closing system and innovation arrangement of the components for very easy operation

Technical specifications

-  Max. 65 kg (143 lbs.)
-  Max. 2600 mm (8'6 3/8")
-  Max. 1400 mm (4'7 1/8")
-  25 mm (31/32")



Installation examples



Set for 2 or 3 wooden doors

	No.
Hawa Combino 65 H MS, door thickness 25 mm (31/32"), for 2 doors	055.3203.071
Hawa Combino 65 H MS, door thickness 25 mm (31/32"), max. door width 1340 mm (4'3/4"), for 3 doors	055.3203.072

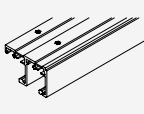
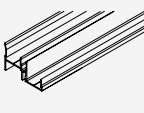
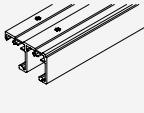
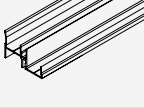
Set consisting of:

		055.3203.071	055.3203.072	No.
	Running gear, steel, zinc-plated	4	6	055.3152.071
	Guide bracket, interior door, steel, zinc-plated	2	4	055.3136.071
	Guide bracket, exterior door, 25 mm (31/32"), steel, zinc-plated	2	2	055.3137.071
	Guide bracket housing, plastic, anthracite	4	6	055.0237.001
	Stopper, plastic, gray	4	4	055.3153.071
	Retention spring for stopper, steel	2	3	055.3190.071
	Stopper guide, plastic, gray	4	4	055.3135.071
	Door follower, with soft close, plastic, gray	1	2	055.0268.001
	Activator, for door follower, steel, zinc-plated	1	2	055.0238.101
	Centering disk, plastic, white	16	24	055.0110.001
	Countersunk head screw, 4.5x25 mm, steel, zinc-plated	32	48	766.5045.125
	Thread-cutting rounded head screw, M4x8 mm, steel, zinc-plated	2	3	762.7009.100
	Thread-cutting rounded head screw, M4x6 mm, steel, zinc-plated	1	2	762.7009.107
	Thread-cutting countersunk head screw, M3x6 mm, steel, zinc-plated	2	4	600.0000.789
	Buffer, with adhesive, 2-piece set	1		053.3364.051

Track sets

	No.
Hawa Combino 65 H MS, 2500 mm (8'2 7/16")	055.3209.071
Hawa Combino 65 H MS, 4000 mm (13'1 15/32")	055.3209.072

Set consisting of:





		mm (inch)	055.3209.071	055.3209.072	No.
	Double running track, aluminum, anodized, pre-drilled	2500 (8'2 7/16")	1		055.3143.250
	Double guide track, aluminum, anodized, pre-drilled	2500 (8'2 7/16")	1		055.3134.250
	Double running track, aluminum, anodized, pre-drilled	4000 (13'1 15/32")		1	055.3143.400
	Double guide track, aluminum, anodized, pre-drilled	4000 (13'1 15/32")		1	055.3134.400

Soft close

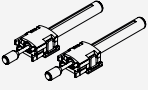

For soft closing in opening and closing direction order 2 sets.

	No.
Hawa Combino 65 H IS/MS, up to 65 kg (143 lbs.), 2 pieces	055.3214.071

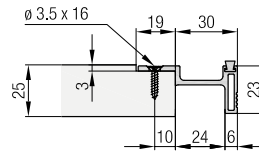
Set consisting of:

		055.3214.071	No.
	Soft close, right, up to 65 kg (143 lbs.)	1	055.3149.071
	Soft close, left, up to 65 kg (143 lbs.)	1	055.3149.072
	Activator, for soft close	2	055.3156.071
	Thread-cutting head screw, M4x8 mm, steel, zinc-plated	2	600.0000.344

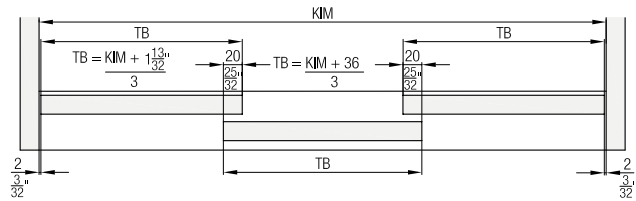
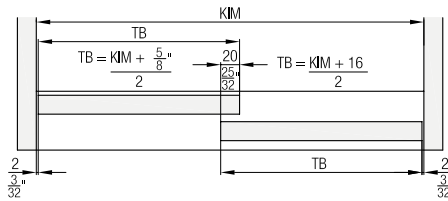
Accessories

		No.
	Soft close for guide (recommended from a door ratio bigger than 1:3. Can only be used with a soft close.)	055.3219.051
	Clip-on component, for wooden panel, every 700-800 mm (2'3 9/16"-2'7 1/2"), aluminum, pre-drilled	055.3155.000

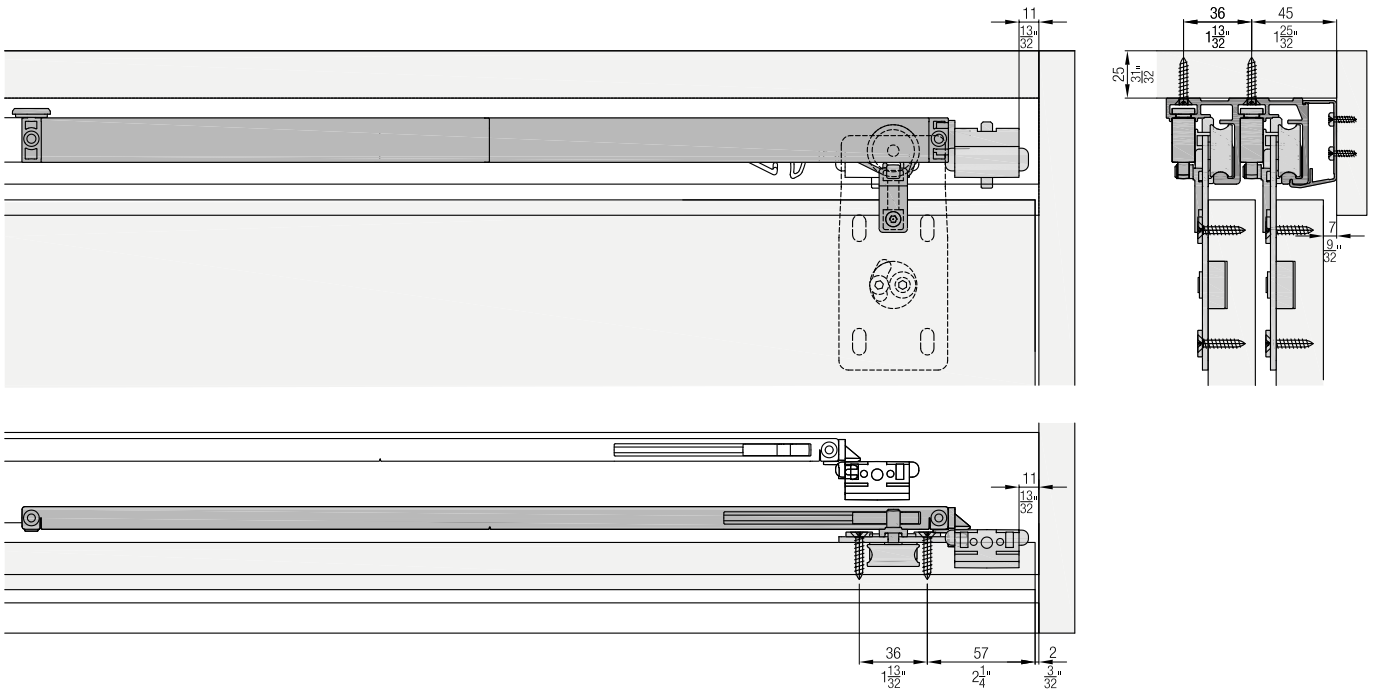
Handle profile



Calculations



Soft close



Accessories



- Straightening fitting from page 236
- Handle profiles from page 238
- Order overview soft close from page 240

Planning/execution





Further information about the product can be found on www.hawa.com.

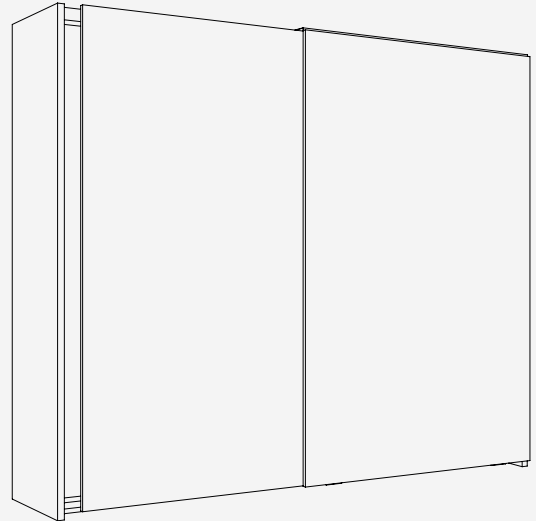
Fitting for 2–3 top-running wooden doors up to 65 kg (143 lbs.) with screwed on running track. Optional soft close integrated in track. Design Forslide top-running.

Product highlights

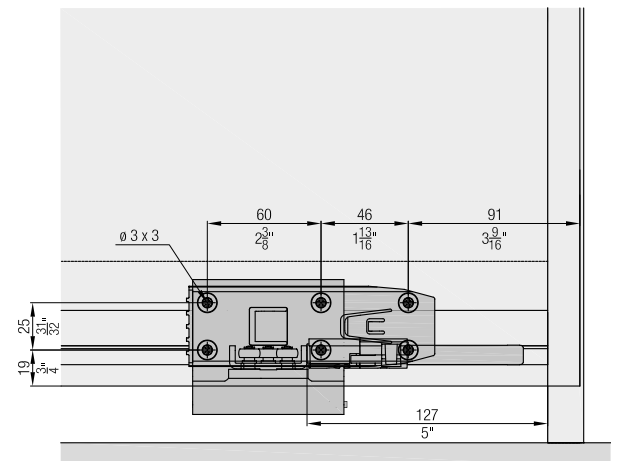
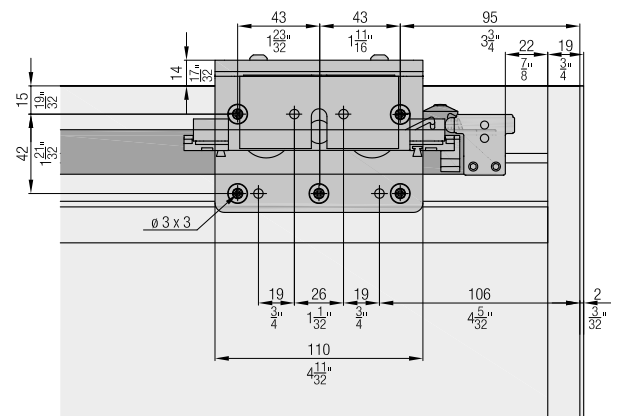
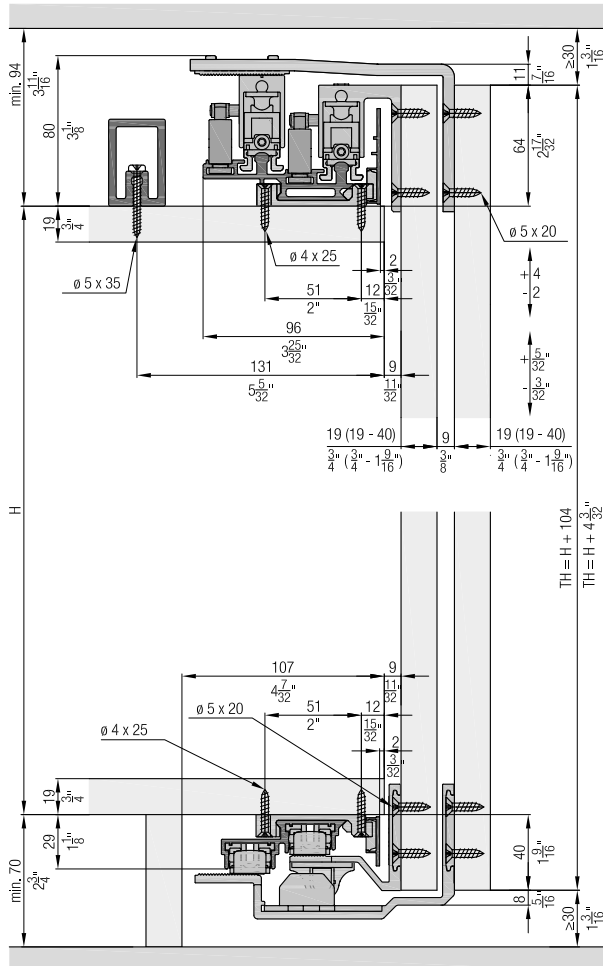
-  **Comfort** Smooth, silent running with Hawa Comfort roller and guide with zero clearance
-  **Comfort** Sophisticated soft close also for center doors and an innovative arrangement of the components make for very easy operation

Technical specifications

-  Max. 65 kg (143 lbs.)
-  Max. 2600 mm (8'6 3/8")
-  Max. 1400 mm (4'7 1/8")
-  19 – 40 mm (3/4" to 1 9/16")



Installation examples



Set for 2 or 3 wooden doors


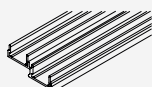
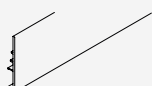

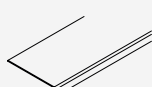
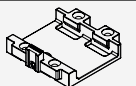
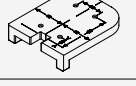


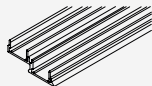
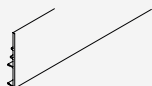

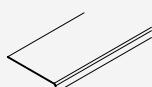
	No.
Hawa Combino 65 H FS ol, door thickness 19–40 mm (3/4"-1 9/16"), for 2 doors	055.3205.071
Hawa Combino 65 H FS ol, door thickness 19–40 mm (3/4"-1 9/16"), max. door width 1350 mm (4'5 5/32"), for 3 doors	055.3205.072

Set consisting of:


		055.3205.071	055.3205.072	No.
	Running gear, interior door, aluminum, anodized	2	4	055.3150.071
	Running gear bracket, exterior door, steel, zinc-plated	2	2	055.3159.071
	Running gear, exterior door, aluminum, anodized	2	2	055.3158.071
	Anti-derailment device, plastic, red	4	6	055.0279.001
	Guide bracket, interior door, aluminum, anodized	2	4	055.3178.071
	Guide bracket, exterior door, aluminum, anodized	2	2	055.3179.071
	Guide plate, plastic, gray	4	6	055.0269.001
	Stopper, left, plastic, gray	2	2	055.3163.071
	Stopper, right, plastic, gray	2	2	055.3163.072
	Stopper guide, plastic, gray	4	4	055.3135.071
	Door follower, with soft close, plastic, gray	1	2	055.0268.001
	Activator, for door follower, steel, zinc-plated	1	2	055.0259.101
	Rounded head screw, M5x16 mm, steel, zinc-plated	4	4	600.0000.782
	Countersunk head screw, 5x20 mm, steel, zinc-plated	42	62	600.0000.787
	Thread-cutting rounded head screw, M4x8 mm, steel, zinc-plated	1	2	762.7009.100
	Thread-cutting head screw, M4x8 mm, steel, zinc-plated	4	6	600.0000.344
	Thread-cutting countersunk head screw, M3x6 mm, steel, zinc-plated	2	4	600.0000.789
	Buffer, with adhesive, 2-piece set		1	053.3364.051

Track sets

	No.
Hawa Combino 65/80 H FS ol, 2500 mm (8'2 7/16")	055.3211.071
Hawa Combino 65/80 H FS ol, 4000 mm (13'1 15/32")	055.3211.072

		mm (inch)	055.3211.071	055.3211.072	No.
Set consisting of:					
	Double running track, aluminum, anodized	2500 (8'2 7/16")	1		055.3183.250
	Double guide track, aluminum, anodized	2500 (8'2 7/16")	1		055.3184.250
	Panel profile running track, aluminum, anodized	2500 (8'2 7/16")	1		055.3181.250
	Panel profile guide track, aluminum, anodized	2500 (8'2 7/16")	1		055.3182.250
	Panel profile cover, aluminum, anodized	1300 (4'3 3/16")	1		055.3170.130
	Fixing adapter, zinc-plated		15	20	055.3180.071
	Drilling jig, plastic, anthracite		1	1	055.0316.001
	Countersunk head screw, 4x25 mm, steel, zinc-plated		60	80	766.5042.125
	Double running track, aluminum, anodized	4000 (13'1 15/32")		1	055.3183.400
	Double guide track, aluminum, anodized	4000 (13'1 15/32")		1	055.3184.400
	Panel profile running track, aluminum, anodized	4000 (13'1 15/32")		1	055.3181.400
	Panel profile guide track, aluminum, anodized	4000 (13'1 15/32")		1	055.3182.400
	Panel profile cover, aluminum, anodized	1600 (5'3")		1	055.3170.160

Reinforcement profile

		mm (inch)	No.
	Reinforcement profile, aluminum, anodized, pre-drilled, recommended from a span width of 800 mm (2'7 1/2")	2500 (8'2 7/16")	055.3185.250
		4000 (13'1 15/32")	055.3185.400

Soft close

For soft closing in opening and closing direction order 2 sets.

		No.
Hawa Combinio 65 H FS ol, up to 65 kg (143 lbs.), 2 pieces	055.3206.071	





Set consisting of:

	Soft close, right, up to 65 kg (143 lbs.)	1	055.3187.074
	Soft close, left, up to 65 kg (143 lbs.)	1	055.3187.073
	Activator, for soft close, plastic, gray	2	055.3186.071
	Thread-cutting rounded head screw, M4x20 mm, steel, zinc-plated	2	600.0000.783
	Thread-cutting countersunk head screw, M4x10 mm, steel, zinc-plated	2	600.0000.778

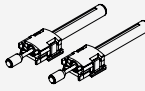
Soft close center door

		No.
Hawa Combinio 65/80 H FS ol, center door	055.3207.071	

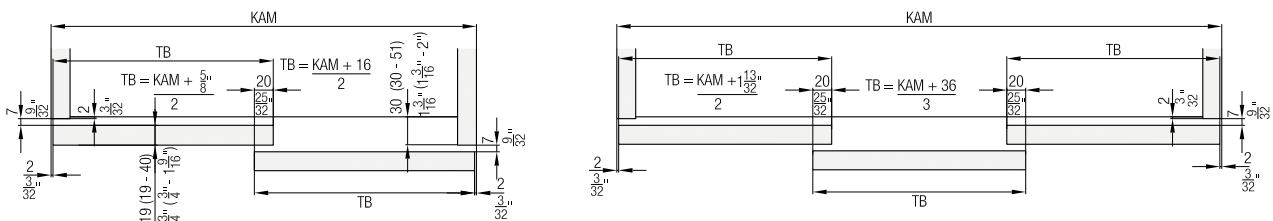
Set consisting of:

	Soft close, center door	1	055.3197.071
	Activator, for soft close center door	1	055.3198.071
	Rubber buffer, plastic, transparent	2	055.0318.001
	Thread-cutting rounded head screw, M4x10 mm, steel, zinc-plated	1	600.0000.790

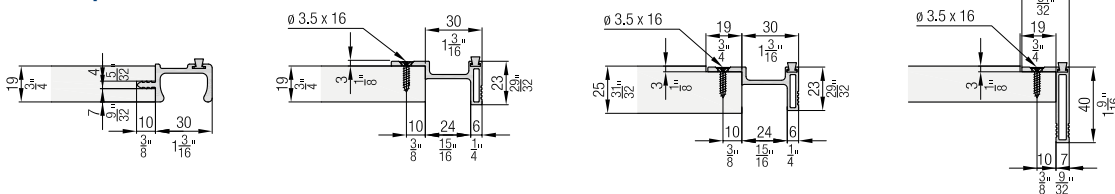
Accessories

		No.
	Soft close for guide (recommended from a door ratio bigger than 1:3. Can only be used with a soft close.)	055.3219.051

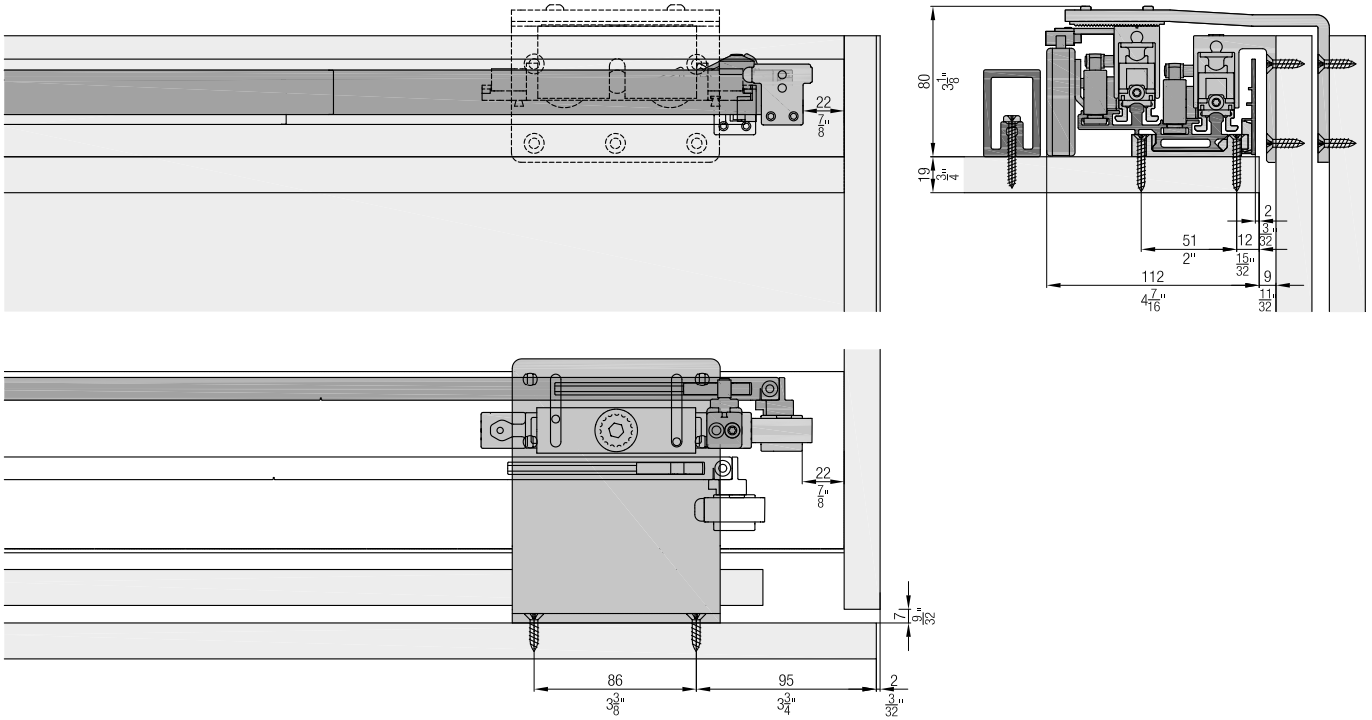
Calculations



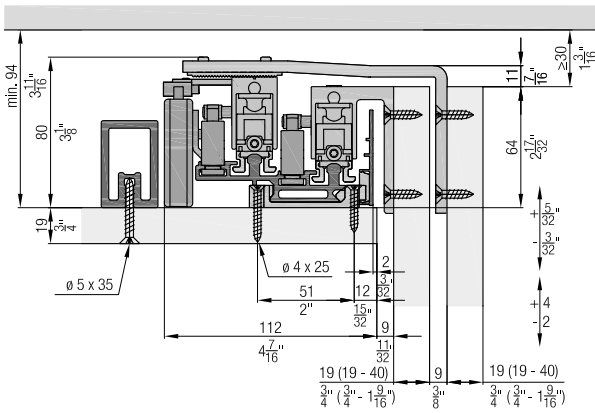
Handle profiles



Soft close



Soft close center door



Accessories



- Straightening fitting from page 236
- Handle profiles from page 238
- Order overview soft close from page 240

Planning/execution

Further information about the product can be found on www.hawa.com.

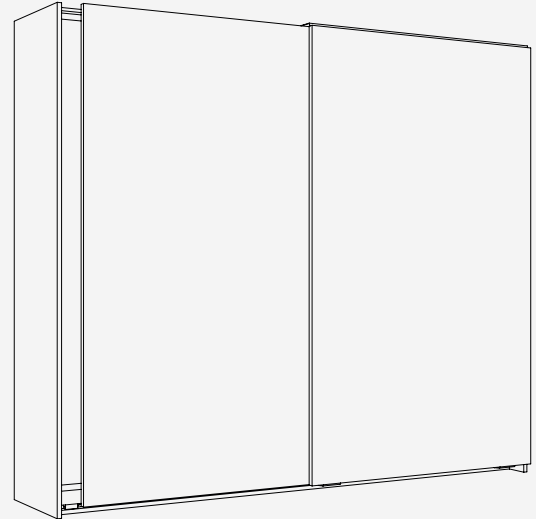
Fitting for 2–3 bottom-running wooden doors up to 65 kg (143 lbs.) with screwed on running track and wooden clip panel. Optional soft close integrated in track. Design Forslide bottom-running.

Product highlights

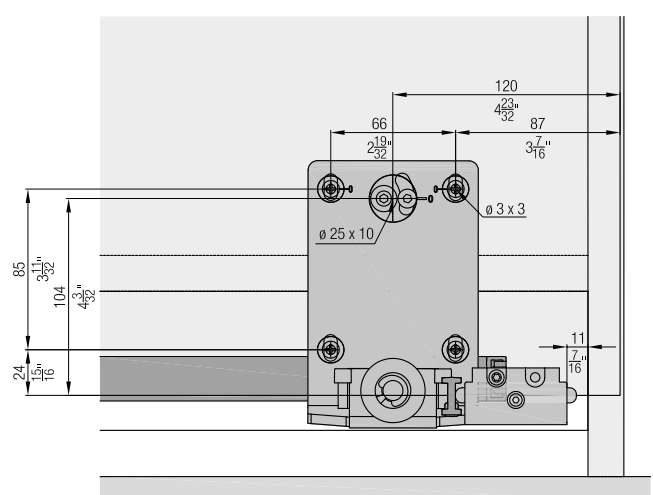
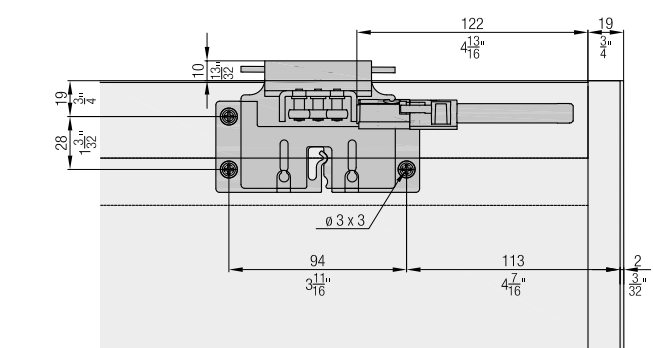
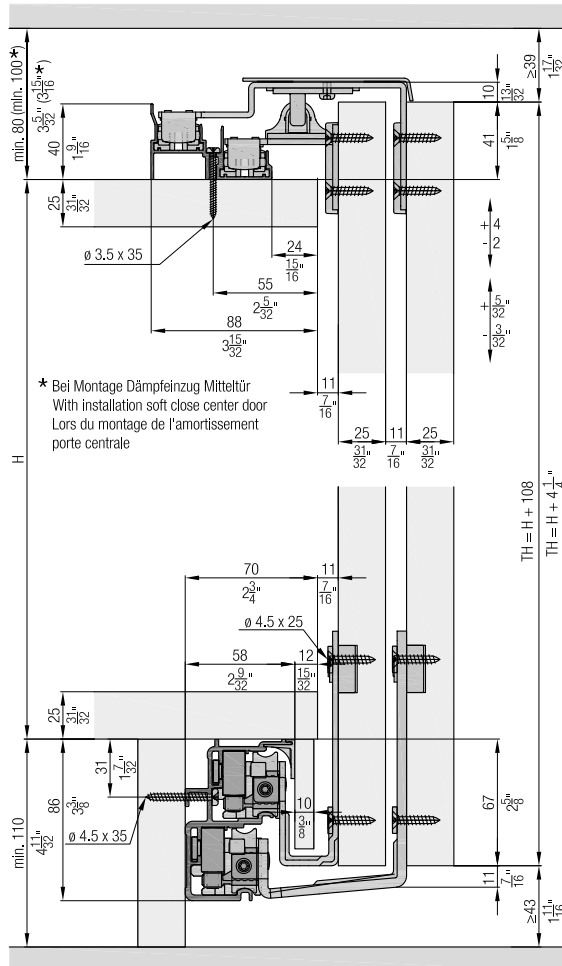
-  **Comfort** Sophisticated soft close also for center doors and an innovative arrangement of the components make for very easy operation
-  **Aesthetics** Bottom-running system that supports the entire door weight on the base makes cabinet designs with thin materials possible

Technical specifications

-  Max. 65 kg (143 lbs.)
-  Max. 2600 mm (8'6 3/8")
-  Max. 1400 mm (4'7 1/8")
-  25 mm (31/32")




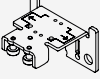
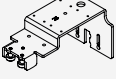









Installation examples



Set for 2 or 3 wooden doors

	No.
Hawa Combino 65 H FS ul, for 2 doors	055.3204.071
Hawa Combino 65 H FS ul, max. door width 1350 mm (4'5 5/32"), for 3 doors	055.3204.072

Set consisting of:

		055.3204.071	055.3204.072	No.
	Running gear, interior door, steel, zinc-plated	2	4	055.3147.071
	Running gear, exterior door, steel, zinc-plated	2	2	055.3146.071
	Guide bracket, interior door, steel, zinc-plated	2	4	055.3136.071
	Guide bracket, exterior door, 25 mm (31/32"), steel, zinc-plated	2	2	055.3137.071
	Guide bracket housing, plastic, anthracite	4	6	055.0237.001
	Stopper, plastic, gray	4	4	055.3145.071
	Retention spring for stopper, plastic, gray	2	3	055.0267.001
	Stopper guide, plastic, gray	4	4	055.3135.071
	Door follower, with soft close, plastic, gray	1	2	055.0268.001
	Activator, for door follower, steel, zinc-plated	1	2	055.0238.101
	Panel clip, plastic, gray	10	15	055.3071.001
	Centering disk, plastic, white	16	24	055.0110.001
	Countersunk head screw, 4.5x25 mm, steel, zinc-plated	32	48	766.5045.125
	Countersunk head screw, 3x10 mm, steel, zinc-plated	10	15	600.0000.395
	Thread-cutting rounded head screw, M4x6 mm, steel, zinc-plated	1	2	762.7009.107
	Thread-cutting countersunk head screw, M3x6 mm, steel, zinc-plated	2	4	600.0000.789
	Buffer, with adhesive, 2-piece set	1		053.3364.051

Track sets

	No.
Hawa Combino 65/80 H FS ul, 2500 mm (8'2 7/16")	055.3210.071
Hawa Combino 65/80 H FS ul, 4000 mm (13'1 15/32")	055.3210.072

Set consisting of:





		mm (inch)	055.3210.071	055.3210.072	No.
	Double running track, aluminum, anodized, pre-drilled	2500 (8'2 7/16")	1		055.3142.250
	Double guide track, aluminum, anodized, pre-drilled	2500 (8'2 7/16")	1		055.3134.250
	Panel profile cover, aluminum, anodized	1300 (4'3 3/16")	1		055.3170.130
	Double running track, aluminum, anodized, pre-drilled	4000 (13'1 15/32")		1	055.3142.400
	Double guide track, aluminum, anodized, pre-drilled	4000 (13'1 15/32")		1	055.3134.400
	Panel profile cover, aluminum, anodized	1600 (5'3")		1	055.3170.160

Soft close

For soft closing in opening and closing direction
order 2 sets.

	No.
Hawa Combino 65 H FS, up to 65 kg (143 lbs.), 2 pieces	055.3212.071

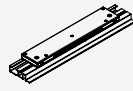
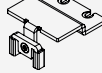





Set consisting of:

		055.3212.071	No.
	Soft close, right, up to 65 kg (143 lbs.)	1	055.3138.073
	Soft close, left, up to 65 kg (143 lbs.)	1	055.3138.074
	Activator, for soft close	2	055.3157.071
	Thread-cutting rounded head screw, M5x16 mm, steel, zinc-plated	2	600.0000.591
	Thread-cutting countersunk head screw, M5x10 mm, steel, zinc-plated	2	600.0000.345

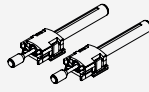
Soft close center door

	No.
Hawa Combino 65/80 H FS, center door	055.3217.071

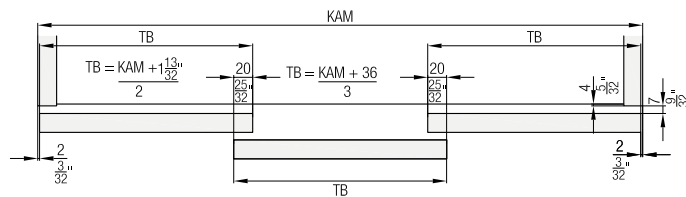
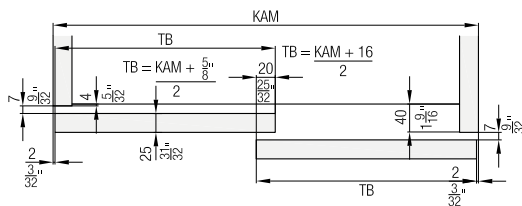
	055.3217.071	No.
Set consisting of:		

	Soft close, center door	1	055.3193.071
	Activator, for soft close center door	1	055.3196.071
	Safety device for guide bracket, plastic, anthracite	1	053.3099.001
	Rubber buffer, plastic, transparent	2	055.0318.001
	Thread-cutting rounded head screw, M4x8 mm, steel, zinc-plated	2	762.7009.100
	Fillister head screw, 4x16 mm, steel, zinc-plated	2	600.0000.166
	Countersunk head screw, 4.5x20 mm, steel, zinc-plated	1	600.0000.167

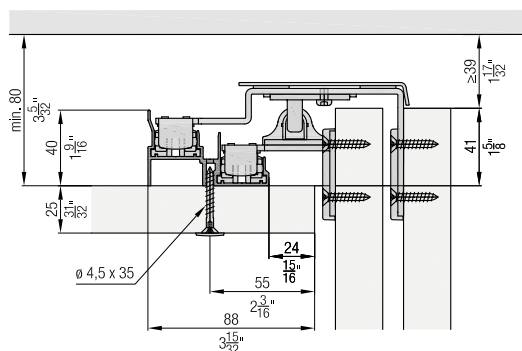
Accessories

	No.	
	Soft close for guide (recommen- ded from a door ratio bigger than 1:3. Can only be used with a soft close.)	055.3219.051

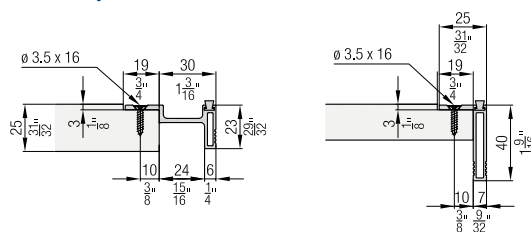
Calculations



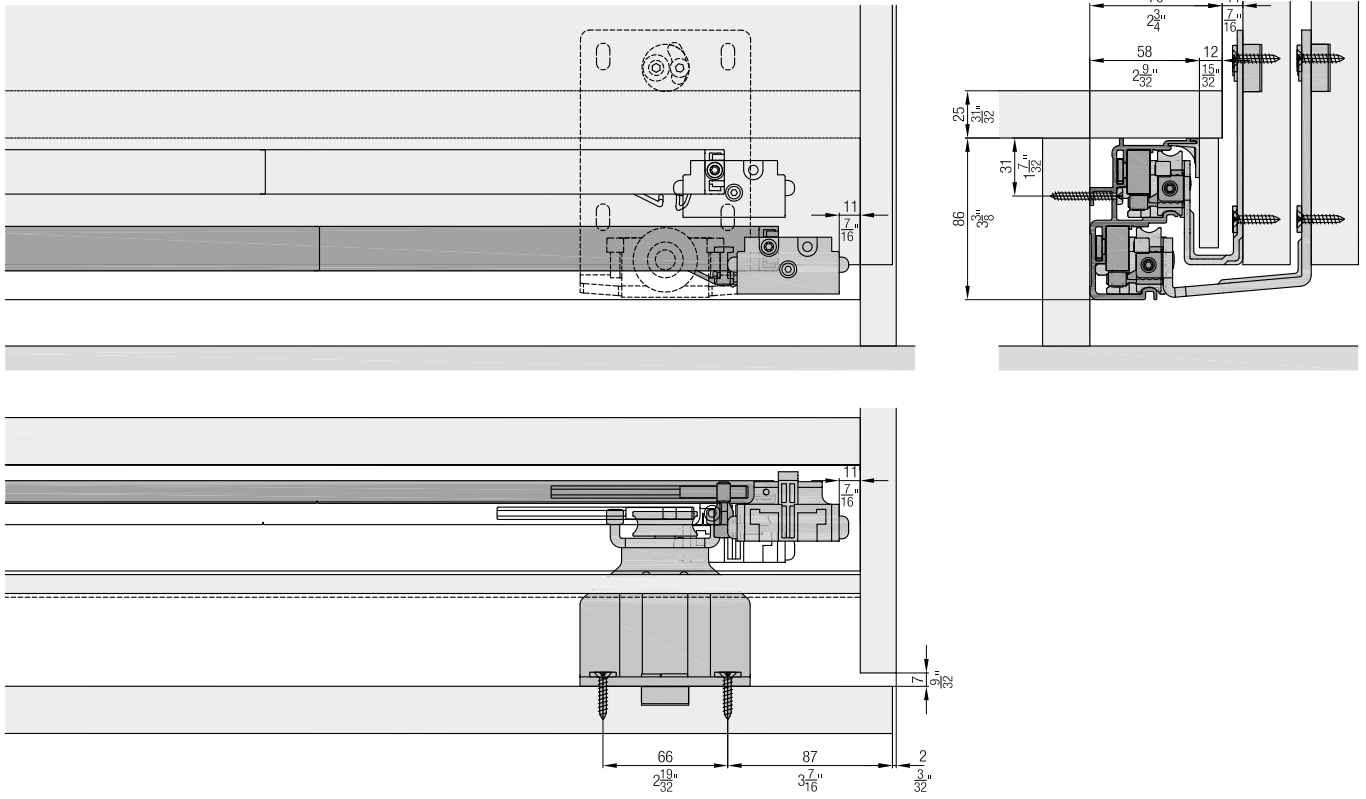
Optional: Guide track installation from below



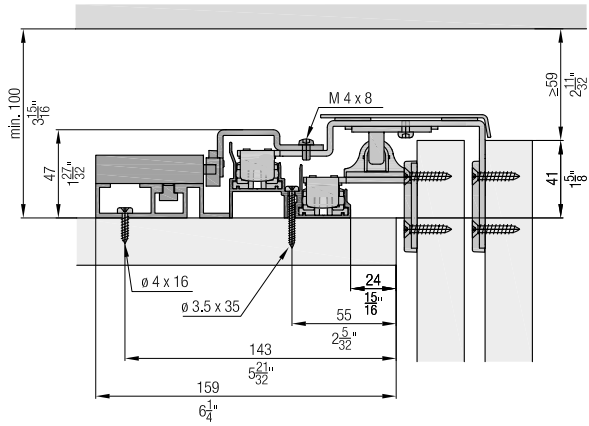
Handle profiles



Soft close



Soft close center door



Accessories



- Straightening fitting from page 236
- Handle profiles from page 238
- Order overview soft close from page 240

Planning/execution

Further information about the product can be found on www.hawa.com.

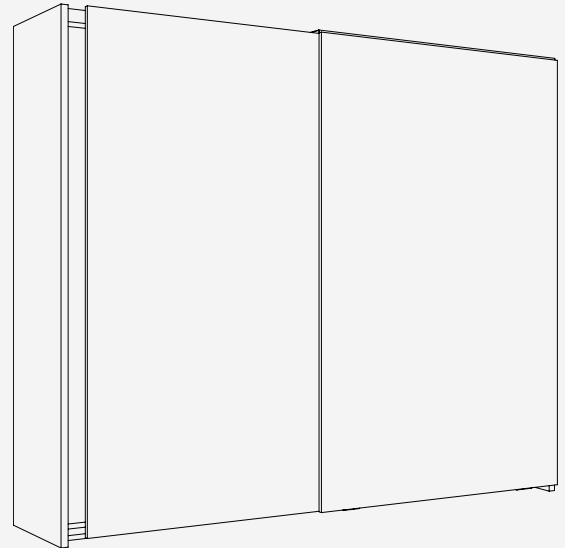
Fitting for 2–3 top-running wooden doors up to 80 kg (176 lbs.) with screwed on running track. Optional soft close integrated in track. Design Forslide top-running.

Product highlights

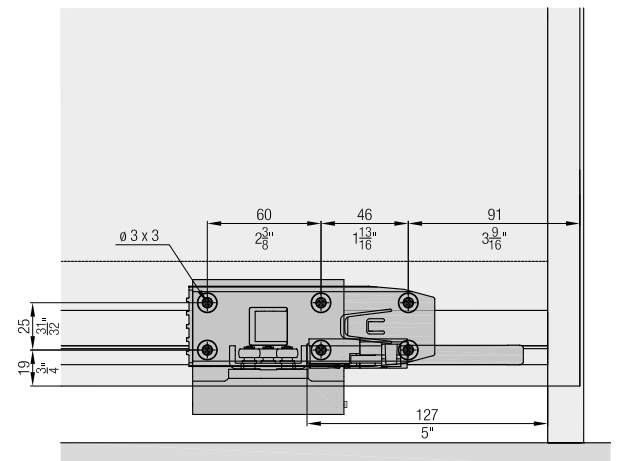
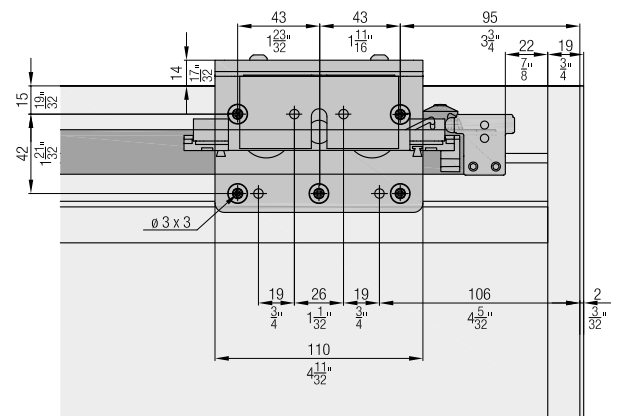
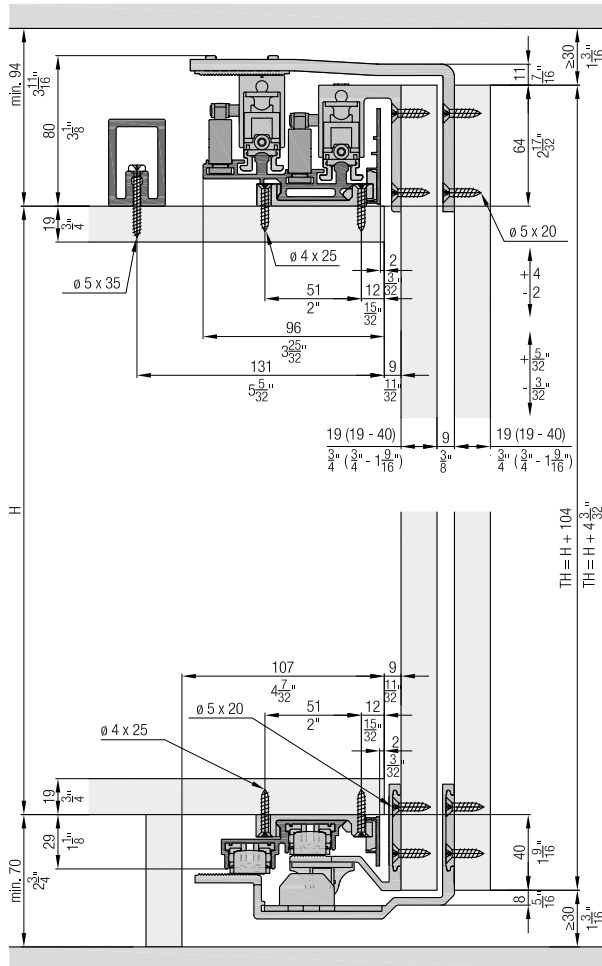
-  **Comfort** Smooth, silent running with Hawa Comfort roller and guide with zero clearance
-  **Comfort** Sophisticated soft close also for center doors and an innovative arrangement of the components make for very easy operation

Technical specifications

-  Max. 80 kg (176 lbs.)
-  Max. 2800 mm (9'2 1/4")
-  Max. 1600 mm (5'3")
-  19–40 mm (3/4" to 1 9/16")



Installation examples



Set for 2 or 3 wooden doors

	No.
Hawa Combino 80 H FS ol, door thickness 19–40 mm (3/4"-1 9/16"), for 2 doors	055.3205.073
Hawa Combino 80 H FS ol, door thickness 19–40 mm (3/4"-1 9/16"), max. door width 1350 mm (4'5 5/32"), for 3 doors	055.3205.074

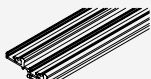
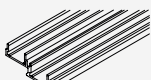
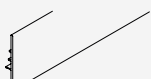


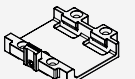
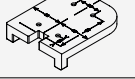



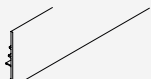


Set consisting of:

		055.3205.073	055.3205.074	No.
	Running gear, interior door, aluminum, anodized	2	4	055.3150.071
	Running gear bracket, exterior door, steel, matt nickel-plated	2	2	055.3159.072
	Running gear, exterior door, aluminum, anodized	2	2	055.3158.071
	Anti-derailment device, plastic, red	4	6	055.0279.001
	Guide bracket, interior door, aluminum, anodized	2	4	055.3178.071
	Guide bracket, exterior door, aluminum, anodized	2	2	055.3179.071
	Guide plate, plastic, gray	4	6	055.0269.001
	Stopper, left, plastic, gray	2	2	055.3163.071
	Stopper, right, plastic, gray	2	2	055.3163.072
	Stopper guide, plastic, gray	4	4	055.3135.071
	Door follower, with soft close, plastic, gray	1	2	055.0268.001
	Activator, for door follower, steel, zinc-plated	1	2	055.0259.101
	Rounded head screw, M5x16 mm, steel, zinc-plated	4	4	600.0000.782
	Countersunk head screw, 5x20 mm, steel, zinc-plated	42	62	600.0000.787
	Thread-cutting rounded head screw, M4x8 mm, steel, zinc-plated	1	2	762.7009.100
	Thread-cutting head screw, M4x8 mm, steel, zinc-plated	4	6	600.0000.344
	Thread-cutting countersunk head screw, M3x6 mm, steel, zinc-plated	2	4	600.0000.789
	Buffer, with adhesive, 2-piece set	1		053.3364.051


Track sets

	No.
Hawa Combino 65/80 H FS ol, 2500 mm (8'2 7/16")	055.3211.071
Hawa Combino 65/80 H FS ol, 4000 mm (13'1 15/32")	055.3211.072

Set consisting of:

		mm (inch)	055.3211.071	055.3211.072	No.
	Double running track, aluminum, anodized	2500 (8'2 7/16")	1		055.3183.250
	Double guide track, aluminum, anodized	2500 (8'2 7/16")	1		055.3184.250
	Panel profile running track, aluminum, anodized	2500 (8'2 7/16")	1		055.3181.250
	Panel profile guide track, aluminum, anodized	2500 (8'2 7/16")	1		055.3182.250
	Panel profile cover, aluminum, anodized	1300 (4'3 3/16")	1		055.3170.130
	Fixing adapter, zinc-plated		15	20	055.3180.071
	Drilling jig, plastic, anthracite		1	1	055.0316.001
	Countersunk head screw, 4x25 mm, steel, zinc-plated		60	80	766.5042.125
	Double running track, aluminum, anodized	4000 (13'1 15/32")	1		055.3183.400
	Double guide track, aluminum, anodized	4000 (13'1 15/32")	1		055.3184.400
	Panel profile running track, aluminum, anodized	4000 (13'1 15/32")	1		055.3181.400
	Panel profile guide track, aluminum, anodized	4000 (13'1 15/32")	1		055.3182.400
	Panel profile cover, aluminum, anodized	1600 (5'3")	1		055.3170.160




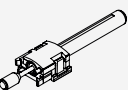



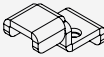

Reinforcement profile

		mm (inch)	No.
	Reinforcement profile, aluminum, anodized, pre-drilled, recommended from a span width of 800 mm (2'7 1/2")	2500 (8'2 7/16")	055.3185.250
		4000 (13'1 15/32")	055.3185.400

Soft close

	No.
Hawa Combinio 80 H FS ol, up to 80 kg (176 lbs.), 4 pieces	055.3206.072
Hawa Combinio 80 H FS ol, up to 80 kg (110-176 lbs.), 6 pieces	055.3206.073





Set consisting of:

		055.3206.072	055.3206.073	No.
	Soft close, right, up to 80 kg (176 lbs.)	2	2	055.3187.072
	Soft close, left, up to 80 kg (176 lbs.)	2	2	055.3187.071
	Activator, for soft close, plastic, gray	4	6	055.3186.071
	Soft close for guide (recommended from a door ratio bigger than 1:3. Can only be used with a soft close.)	4	4	055.3148.071
	Thread-cutting rounded head screw, M4x20 mm, steel, zinc-plated	4	4	600.0000.783
	Thread-cutting counter-sunk head screw, M4x10 mm, steel, zinc-plated	4	4	600.0000.778
	Soft close, with 3 doors, up to 80 kg (176 lbs.)		2	055.3189.071
	End stop, interior door, in opening direction, steel, zinc-plated		2	055.0304.101
	Thread-cutting rounded head screw, M4x12 mm, steel, zinc-plated		2	600.0000.785

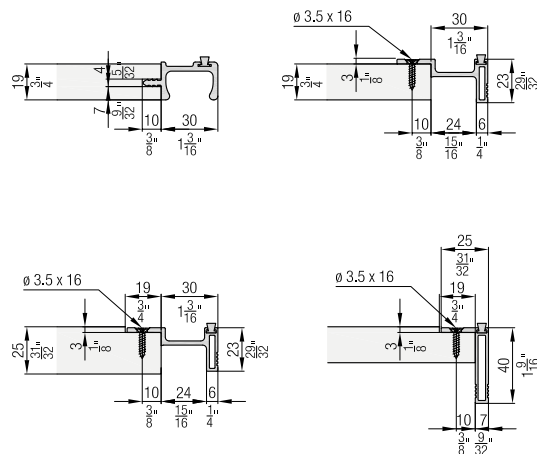
Soft close center door

	No.
EKU Combinio 65/80 H FS ol, center door	055.3207.071

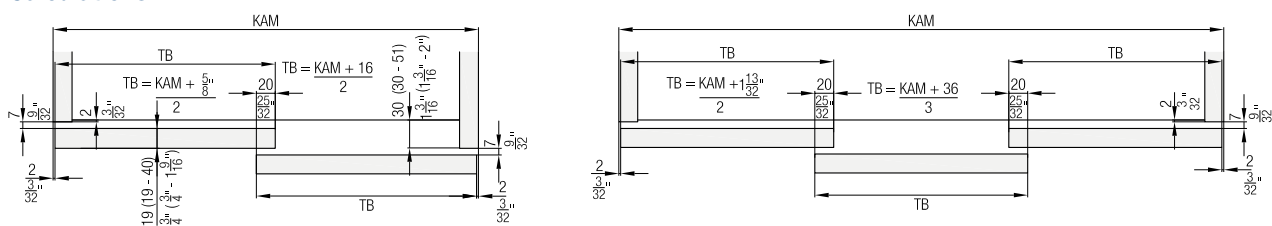
Set consisting of:

		055.3207.071	No.
	Soft close, center door	1	055.3197.071
	Activator, for soft close center door	1	055.3198.071
	Rubber buffer, plastic, transparent	2	055.0318.001
	Thread-cutting rounded head screw, M4x10 mm, steel, zinc-plated	1	600.0000.790

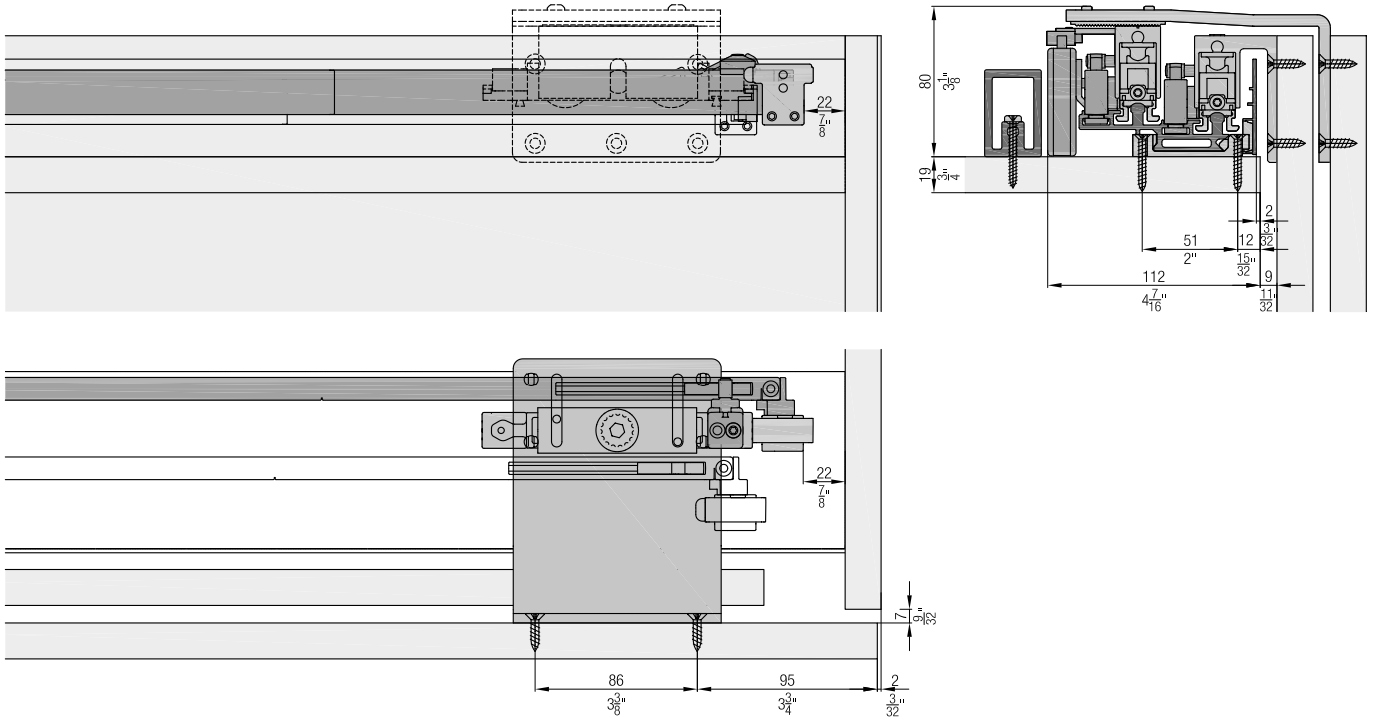
Handle profiles



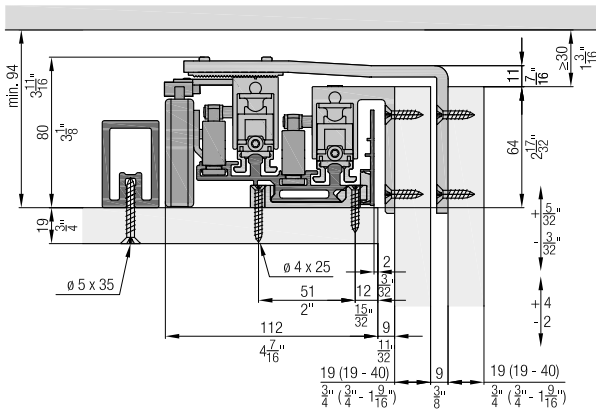
Calculations



Soft close



Soft close center door



Accessories

- Straightening fitting from page 236
- Handle profiles from page 238
- Order overview soft close from page 240

Planning/execution

Further information about the product can be found on www.hawa.com.

Fitting for 2-3 bottom-running wooden doors up to 80 kg (176 lbs.), with screwed on running track and wooden clip panel. Optional soft close integrated in track. Design Forslide bottom-running.

Product highlights



Comfort

Sophisticated soft close also for center doors and an innovative arrangement of the components make for very easy operation



Aesthetics

Bottom-running system that supports the entire door weight on the base makes cabinet designs with thin materials possible

Technical specifications



Max. 80 kg (176 lbs.)



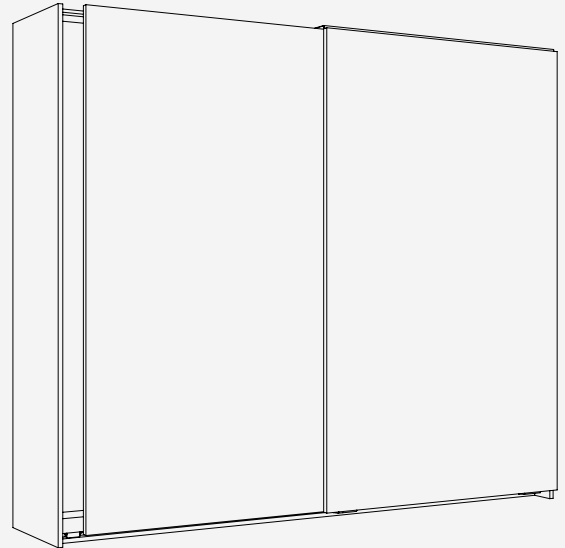
Max. 2800 mm (9'2 1/4")



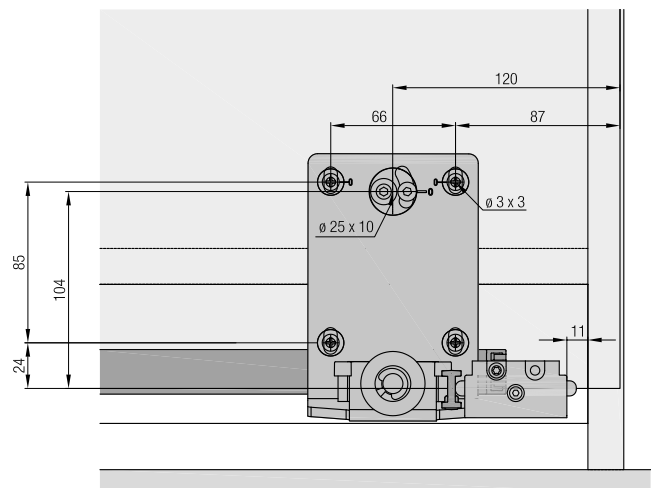
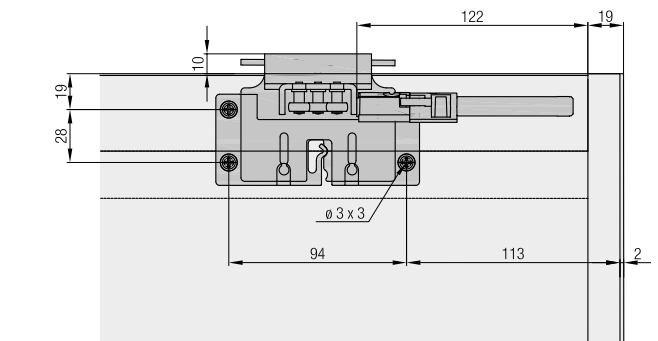
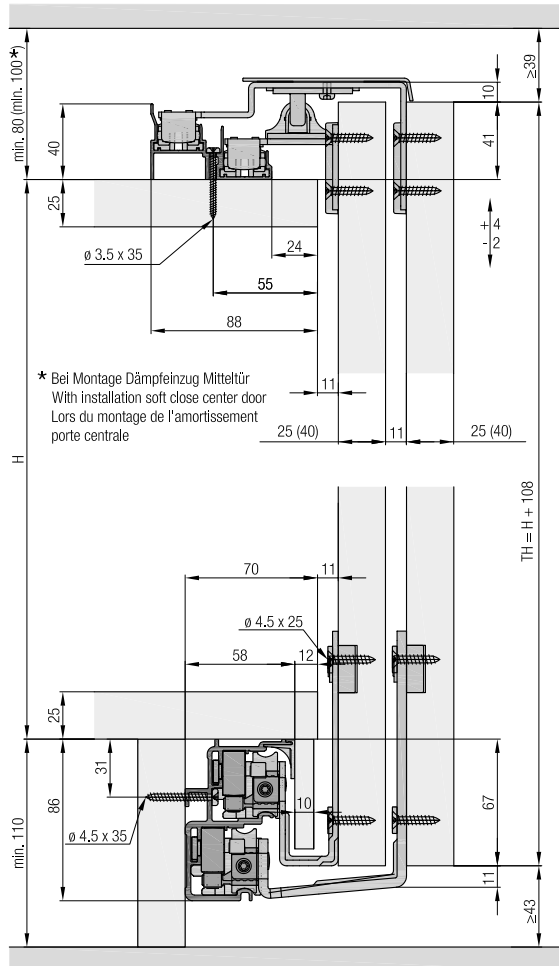
Max. 1600 mm (5'3")



25/40 mm (31/32" or 1 9/16")















Installation examples



Set for 2 or 3 wooden doors, 25 mm (31/32")

	No.
Hawa Combino 80 H FS ul, door thickness 25 mm (31/32"), for 2 doors	055.3201.072
Hawa Combino 80 H FS ul, door thickness 25 mm (31/32"), max. door width 1350 mm (4'5 5/32"), for 3 doors	055.3201.074

Set consisting of:

		055.3201.072	055.3201.074	No.
	Running gear, interior door, steel, zinc-plated	2	4	055.3147.071
	Running gear, exterior door, 25 mm (31/32"), steel, matt nickel-plated	2	2	055.3146.072
	Guide bracket, interior door, steel, zinc-plated	2	4	055.3136.071
	Guide bracket, exterior door, 25 mm (31/32"), steel, zinc-plated	2	2	055.3137.071
	Guide bracket housing, plastic, anthracite	4	6	055.0237.001
	Stopper, plastic, gray	4	4	055.3145.071
	Retention spring for stopper, plastic, gray	2	3	055.0267.001
	Stopper guide, plastic, gray	4	4	055.3135.071
	Door follower, with soft close, plastic, gray	1	2	055.0268.001
	Activator, for door follower, steel, zinc-plated	1	2	055.0238.101
	Panel clip, plastic, gray	10	15	055.3071.001
	Centering disk, plastic, white	16	24	055.0110.001
	Countersunk head screw, 4.5x25 mm, steel, zinc-plated	32	48	766.5045.125
	Countersunk head screw, 3x10 mm, steel, zinc-plated	10	15	600.0000.395
	Thread-cutting rounded head screw, M4x6 mm, steel, zinc-plated	1	2	762.7009.107
	Thread-cutting countersunk head screw, M3x6 mm, steel, zinc-plated	2	4	600.0000.789
	Buffer, with adhesive, 2-piece set	1		053.3364.051

Set for 2 or 3 wooden doors, 40 mm (1 9/16")

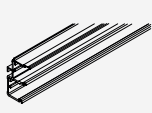
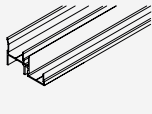
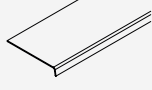
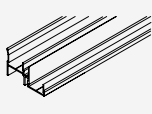
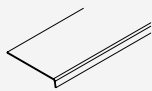
	No.
Hawa Combino 80 H FS ul, door thickness 40 mm (1 9/16"), for 2 doors	055.3201.071
Hawa Combino 80 H FS ul, door thickness 40 mm (1 9/16"), max. door width 1350 mm (4'5 5/32"), for 3 doors	055.3201.073

Set consisting of:

		055.3201.071	055.3201.073	No.
	Running gear, interior door, steel, zinc-plated	2	4	055.3147.071
	Running gear, exterior door, 40 mm (1 9/16"), steel, matt nickel-plated	2	2	055.3146.074
	Guide bracket, interior door, steel, zinc-plated	2	4	055.3136.071
	Guide bracket, exterior door, 40 mm (1 9/16"), steel, zinc-plated	2	2	055.3137.073
	Guide bracket housing, plastic, anthracite	4	6	055.0237.001
	Stopper, plastic, gray	4	4	055.3145.071
	Retention spring for stopper, plastic, gray	2	3	055.0267.001
	Stopper guide, plastic, gray	4	4	055.3135.071
	Door follower, with soft close, plastic, gray	1	2	055.0268.001
	Activator, for door follower, steel, zinc-plated	1	2	055.0238.101
	Panel clip, plastic, gray	10	15	055.3071.001
	Centering disk, plastic, white	16	24	055.0110.001
	Countersunk head screw, 4.5x25 mm, steel, zinc-plated	32	48	766.5045.125
	Countersunk head screw, 3x10 mm, steel, zinc-plated	10	15	600.0000.395
	Thread-cutting rounded head screw, M4x6 mm, steel, zinc-plated	1	2	762.7009.107
	Thread-cutting countersunk head screw, M3x6 mm, steel, zinc-plated	2	4	600.0000.789
	Buffer, with adhesive, 2-piece set	1		053.3364.051




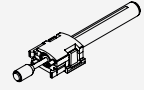


Track sets

	No.
Hawa Combino 65/80 H FS ul, 2500 mm (8'2 7/16")	055.3210.071
EKU Combino 65/80 H FS ul, 4000 mm (13'1 15/32")	055.3210.072

	mm (inch)	055.3210.071	055.3210.072	No.
Set consisting of:				
 Double running track, aluminum, anodized, pre-drilled	2500 (8'2 7/16")	1		055.3142.250
 Double guide track, aluminum, anodized, pre-drilled	2500 (8'2 7/16")	1		055.3134.250
 Panel profile cover, aluminum, anodized	1300 (4'3 3/16")	1		055.3170.130
 Double running track, aluminum, anodized, pre-drilled	4000 (13'1 15/32")		1	055.3142.400
 Double guide track, aluminum, anodized, pre-drilled	4000 (13'1 15/32")		1	055.3134.400
 Panel profile cover, aluminum, anodized	1600 (5'3")		1	055.3170.160

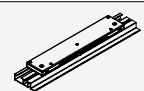
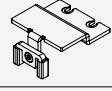





Soft close

	No.
Hawa Combino 80 FS ul, 65–80 kg (143-176 lbs.), 4 pieces	055.3213.071

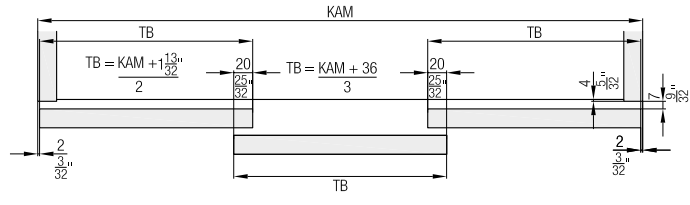
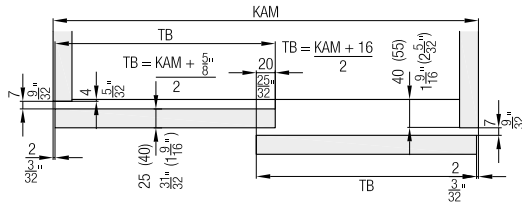
	055.3213.071	No.
Set consisting of:		
 Soft close, right, up to 80 kg (176 lbs.)	2	055.3138.071
 Soft close, left, up to 80 kg (176 lbs.)	2	055.3138.072
 Activator, for soft close	4	055.3157.071
 Soft close for guide (recommended from a door ratio bigger than 1:3. Can only be used with a soft close.)	4	055.3148.071
 Thread-cutting rounded head screw, M5x16 mm, steel, zinc-plated	4	600.0000.591
 Thread-cutting countersunk head screw, M5x10 mm, steel, zinc-plated	4	600.0000.345

Soft close center door

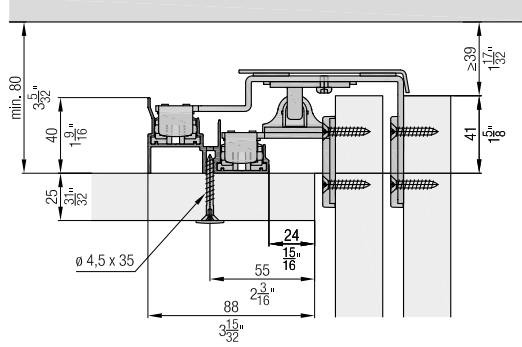
	No.
Hawa Combino 65/80 H FS, center door	055.3217.071

	055.3217.071	No.
Set consisting of:		
 Soft close, center door	1	055.3193.071
 Activator, for soft close center door	1	055.3196.071
 Safety device for guide bracket, plastic, anthracite	1	053.3099.001
 Rubber buffer, plastic, transparent	2	055.0318.001
 Thread-cutting rounded head screw, M4x8 mm, steel, zinc-plated	2	762.7009.100
 Fillister head screw, 4x16 mm, steel, zinc-plated	2	600.0000.166
 Countersunk head screw, 4.5x20 mm, steel, zinc-plated	1	600.0000.167

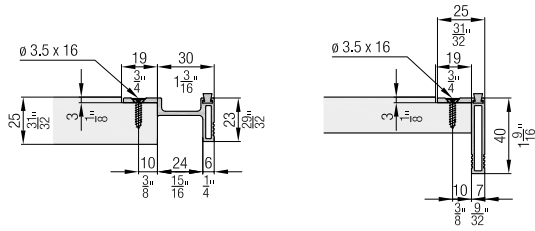
Calculations



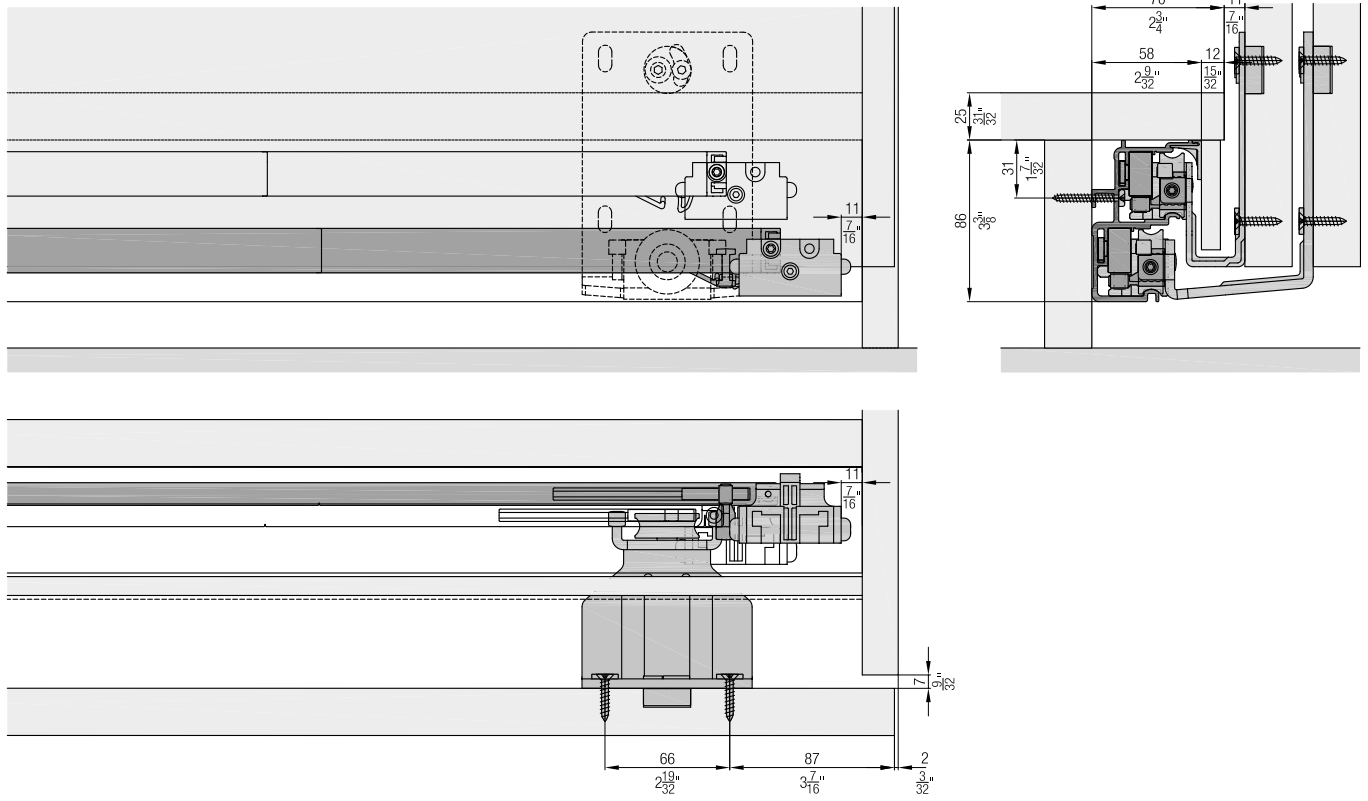
Optional: Guide track installation from below



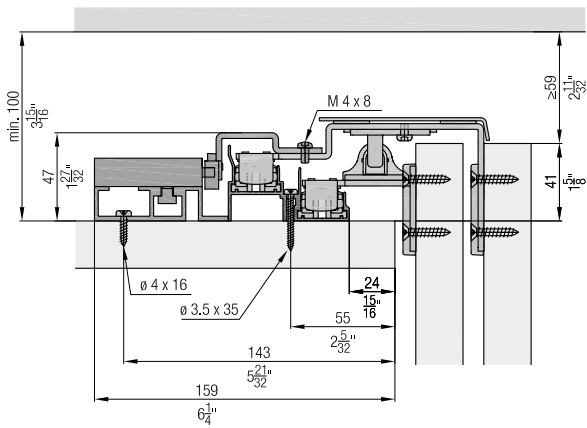
Handle profiles



Soft close



Soft close center door



Accessories

- Straightening fitting from page 236
- Handle profiles from page 238
- Order overview soft close from page 240

Planning/execution

Further information about the product can be found on www.hawa.com.

Hawa Combino L 40 for L-shaped wooden sliding doors New options for furniture designers






Furniture with sliding doors can be viewed from a completely different perspective with the Hawa Combino L 40. Because this sophisticated fitting moves up to four angular wooden doors weighing up to 40 kg over a cabinet, individually or symmetrically in pairs using the Hawa Combino L 40 Synchro. This makes it possible to access the interior of a furniture item simultaneously from the front and above, which paves the way to trendy sideboards and intelligent multimedia applications. As innovative as the concept is, you don't have to forego the traditional qualities of Hawa Sliding Solutions: Operation is extremely convenient thanks to the best running characteristics, guide with zero clearance and integrated soft closing mechanism, and installation is easy thanks to the high degree of pre-installation and flexible adjusting options.







Area of application

Unconventional sideboards positioned on the wall or in the room and ultra-modern, clever multimedia furniture for private living and dining areas.

System advantages

-  **Flexibility** **Maximum design freedom** and **wide range of applications** for 1 to 4 doors in an L-shape, with optional **Symmetric function**
-  **Productivity** **High degree of pre-assembly** for quick, easy installation
Intuitive, **continuous adjustment** of all components
-  **Comfort** **Convenient sliding** with play-free running and guide systems and **integrated soft closing technology**
-  **Aesthetics** **Invisible technology** makes high-quality, **unique cabinet design** possible
-  **Security** Innovative, intelligent technology guarantees a **high degree of functional**

Technical specifications

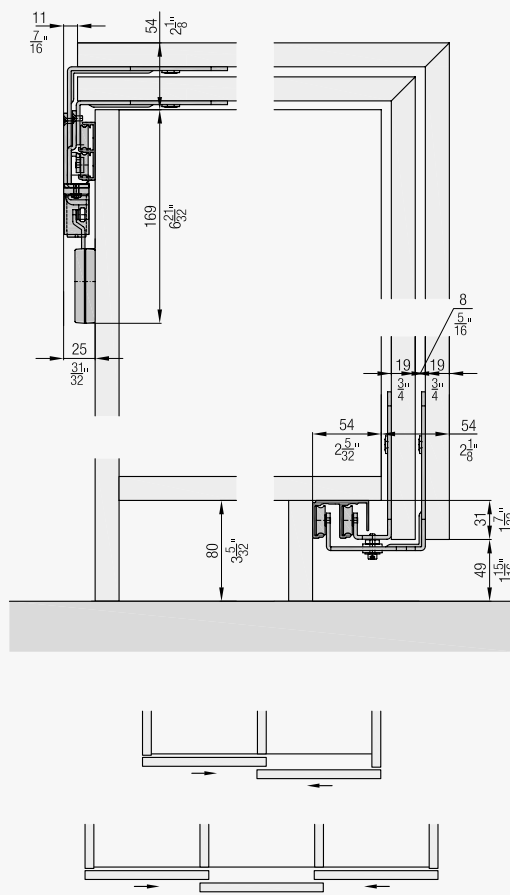
-  max. 40 kg
-  max. 1500 mm
-  max. 1500 mm
-  19 mm

Good to know (accessories)

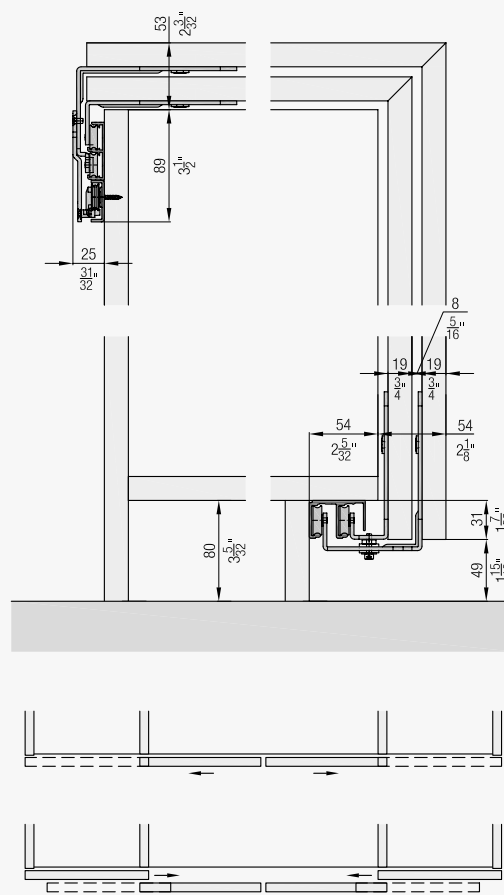
- Straightening fitting for doors
- Handle profiles
- Soft close

Installation examples

Hawa Combino L 40 H FS





Hawa Combino L 40 H FS Synchro







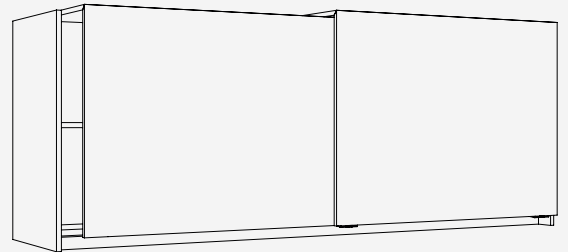
Fitting for 1–3 bottom-running L-shaped wooden doors up to 40 kg (88 lbs.). Soft close optional. Design Forslide.

Product highlights

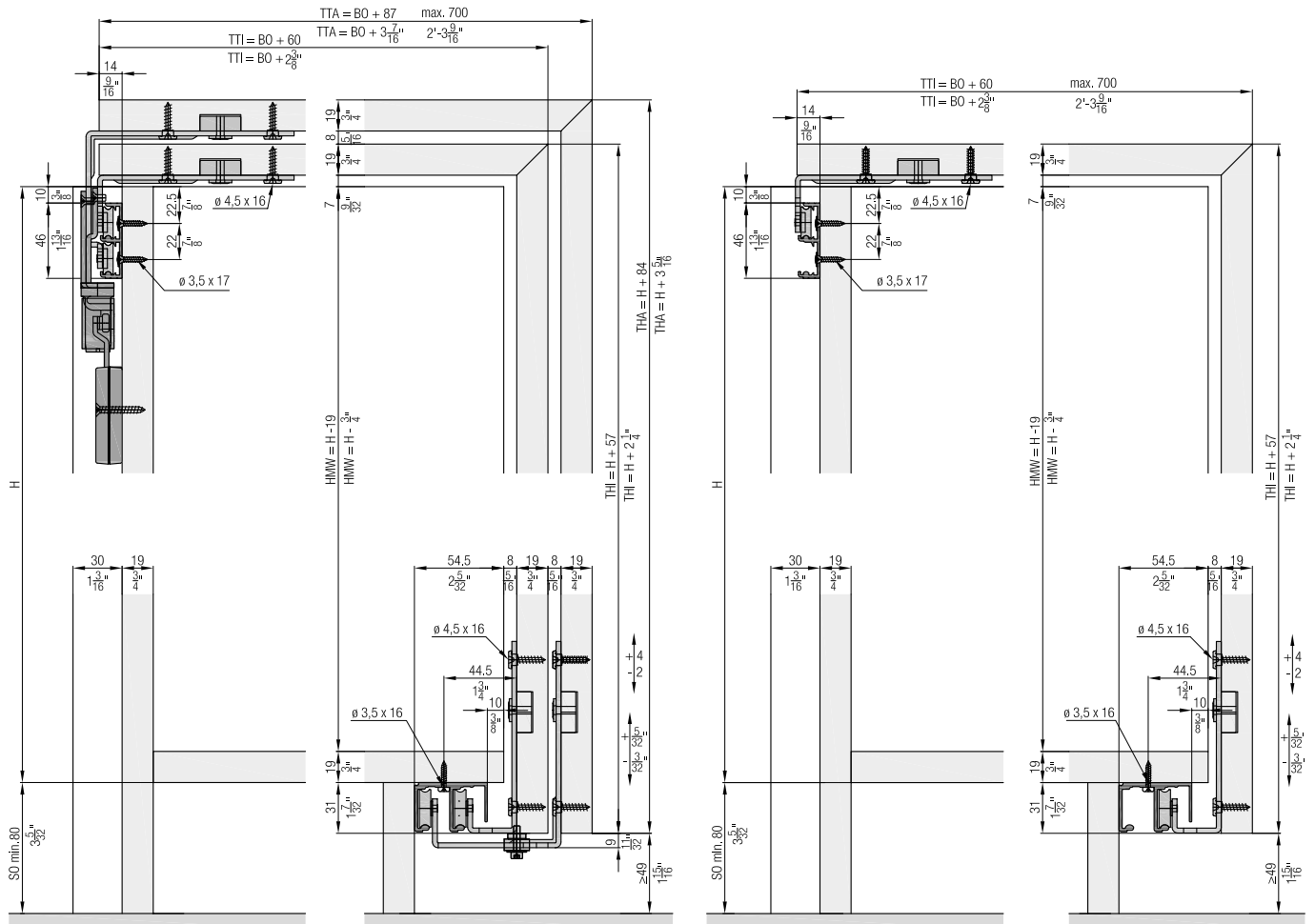
-  **Comfort** High operating convenience thanks to proven running system and soft closing technology which is integrated in the system
-  **Aesthetics** L-shaped doors for a unique cabinet design with access to the cabinet interior from two sides

Technical specifications

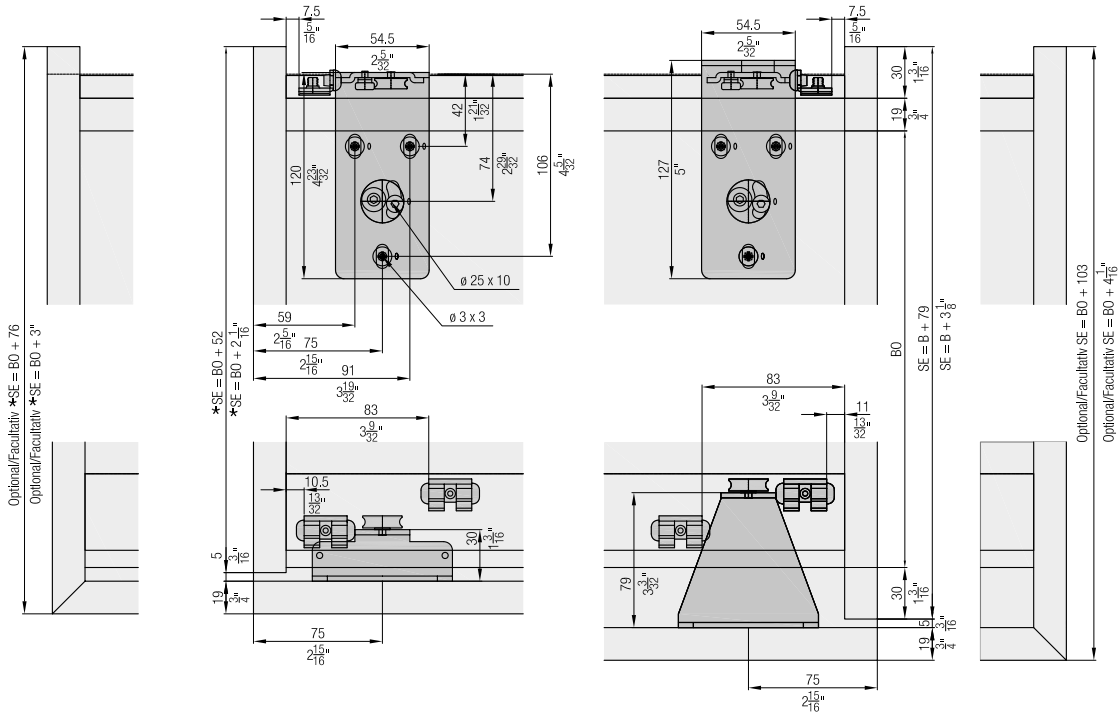
-  Max. 40 kg (88 lbs.)
-  Max. 1500 mm (4'11 1/16")
-  Max. 1500 mm (4'11 1/16")
-  19 mm (3/4")



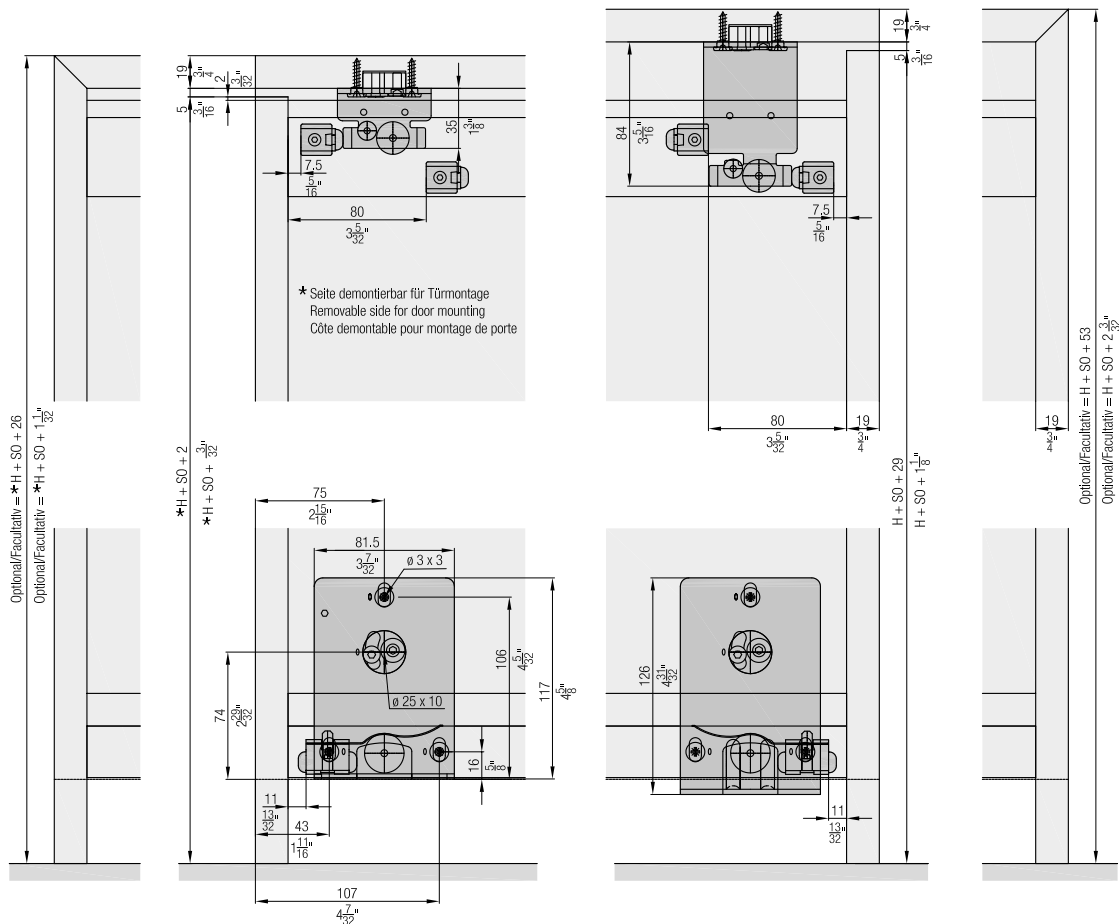
Installation examples



From above




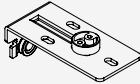






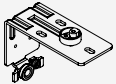


From front



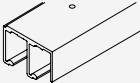
Set for 1 to 3 wooden doors

	No.
Hawa Combino L 40 H FS, for 1 wooden door	056.3160.071
Hawa Combino L 40 H FS, for 2 wooden doors	056.3160.072
Hawa Combino L 40 H FS, for 3 wooden doors	056.3160.073


Set consisting of:

		056.3160.071	056.3160.072	056.3160.073	No.
	Running gear, interior door, steel, zinc-plated	2	2	4	056.3155.171
	Guide bracket, interior door, steel, zinc-plated	2	2	4	056.3157.171
	Stopper, plastic, gray	2	4	4	056.3151.071
	Catch spring, steel	2	2	3	056.0174.001
	Stopper, steel, zinc-plated	2	4	4	056.3150.171
	Washer-and-screw assembly, 4.5x17 mm, steel, zinc-plated	12	24	36	055.0100.101
	Wood screw, 3.5x17 mm, steel, zinc-plated	16	16	16	766.6052.100
	Running gear, exterior door, steel, zinc-plated		2	2	056.3154.171
	Guide bracket, exterior door, steel, zinc-plated		2	2	056.3156.171
	Door follower, with 2-3 doors		1	2	056.3162.171
	Rubber buffer, plastic, grey			3	025.0107.001

Running tracks

		mm (inch)	No.
	Double running track, aluminum, anodized, pre-drilled	2500 (8'2 7/16")	056.3149.250
		3500 (11'5 25/32")	056.3149.350
		6000 (19'8 7/32")	056.3149.600

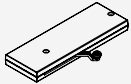
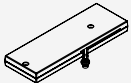




Guide tracks

		mm (inch)	No.
	Double guide track, aluminum, anodized, pre-drilled	2500 (8'2 7/16")	056.3148.250
		3500 (11'5 25/32")	056.3148.350
		6000 (19'8 7/32")	056.3148.600

Soft close (only for system with 2 doors)

	No.
Soft close, 18–40 kg (40–88 lbs.), with narrow follower, 2 pieces	055.3091.074





Set consisting of:

		055.3091.074	No.
	Soft close, left, 18–40 kg (40–88 lbs.)	1	055.3090.073
	Soft close, right, 18–40 kg (40–88 lbs.)	1	055.3090.074
	Follower, for soft close, right, plastic, gray	1	055.3041.071
	Follower, for soft close, left, plastic, gray	1	055.3041.072
	Fillister head screw, 4x16 mm, steel, zinc-plated	4	600.0000.166
	Countersunk head screw, 4x30 mm, steel, zinc-plated	4	600.0000.439

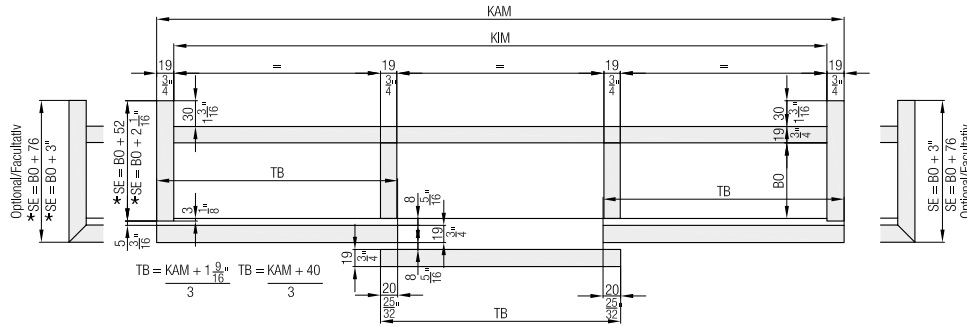
Adapter soft close

	No.
Adapter set, for soft close	056.3164.071

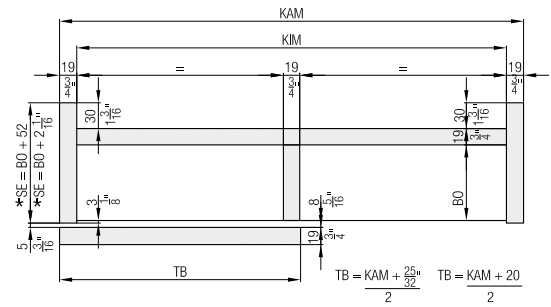
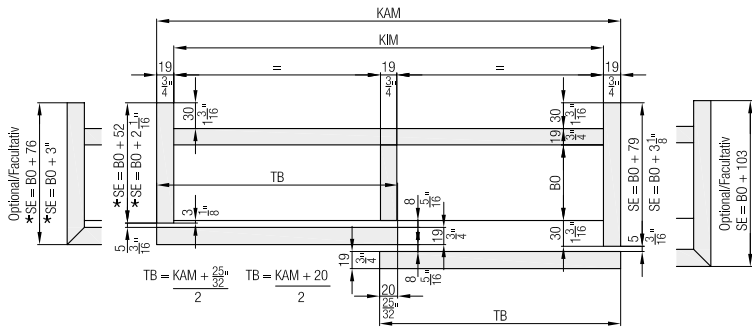
Set consisting of:

		056.3164.071	No.
	Adapter, for soft close, exterior door, top, steel, zinc-plated	1	056.0179.101
	Adapter, for soft closing system, interior door, top, steel, zinc-plated	1	056.0179.102
	Rounded head screw, M4x8 mm, steel, zinc-plated	4	759.0408.108
	Thread-cutting head screw, M4x8 mm, steel, zinc-plated	4	600.0000.344

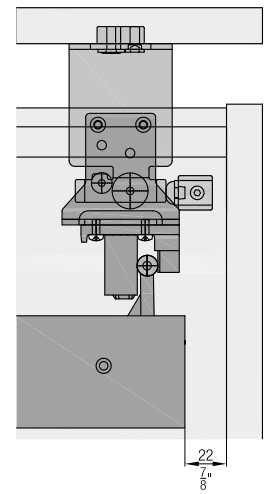
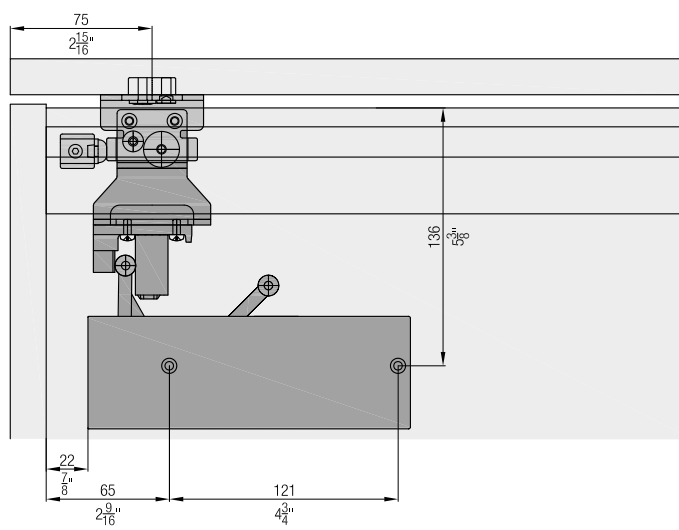
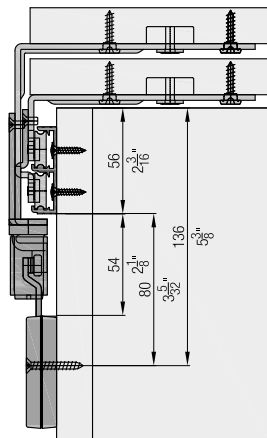
Calculation



* Seite demontierbar für Türmontage
Removable side for door mounting
Côté démontable pour montage de porte



Soft close



Accessories



- Straightening fitting from page 236
- Order overview soft close from page 240

Planning/execution

Further information about the product can be found on www.hawa.com.

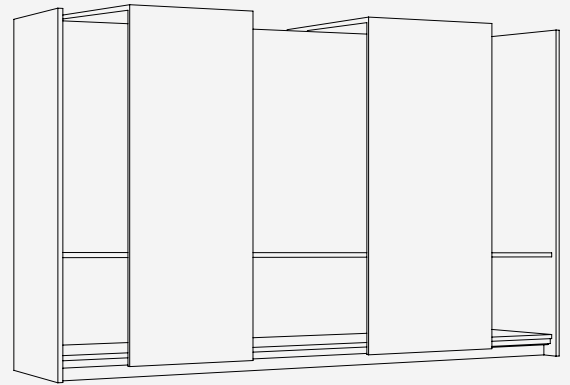
Fitting for 2 or 4 synchronously running L-shaped wooden doors up to 40 kg (88 lbs.) Design Forslide

Product highlights

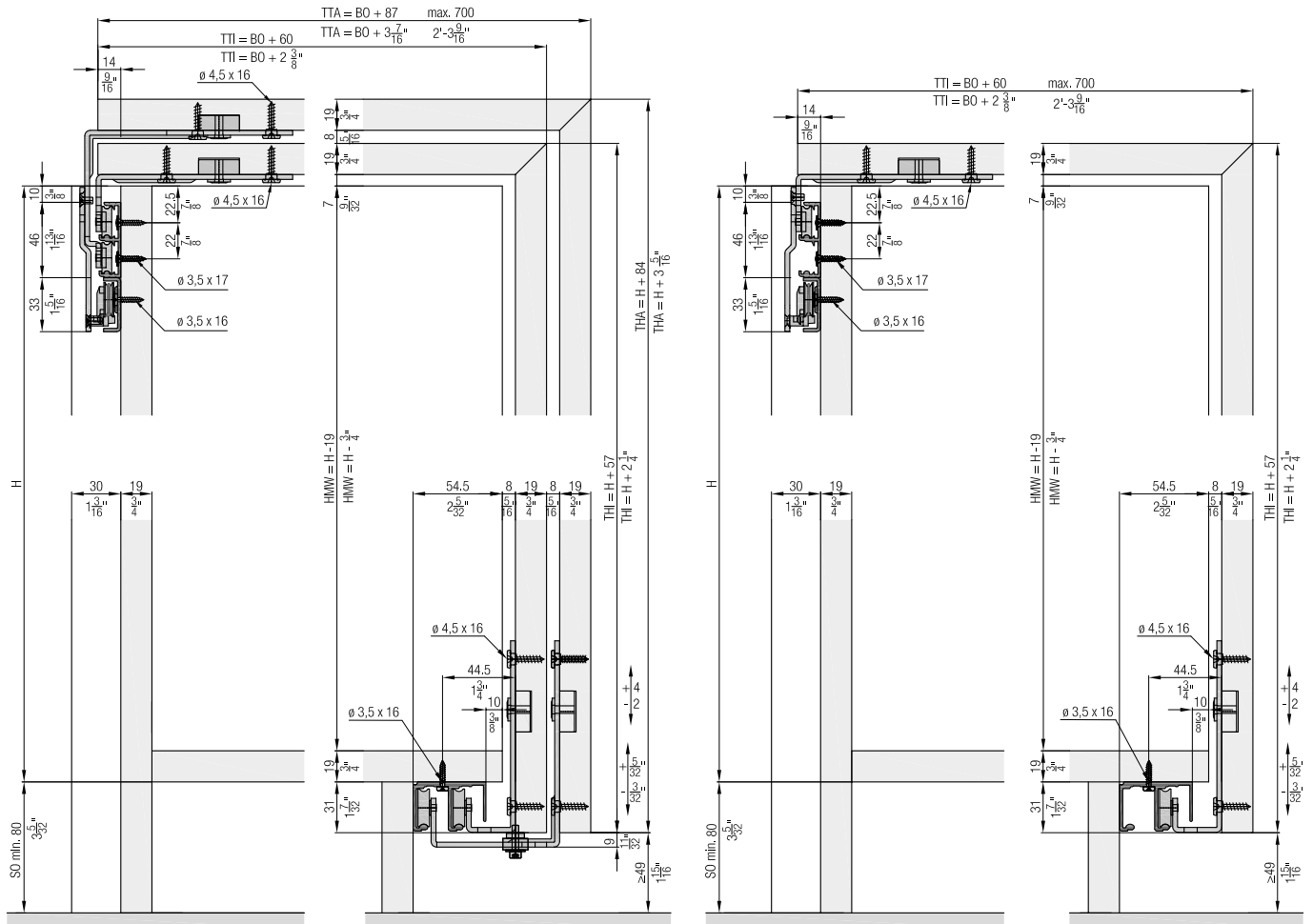
-  **Comfort** High operating convenience thanks to proven running system and soft closing technology which is integrated in the system
-  **Aesthetics** Synchronously running L-shaped doors for a unique cabinet design with access to the cabinet interior from two sides

Technical specifications

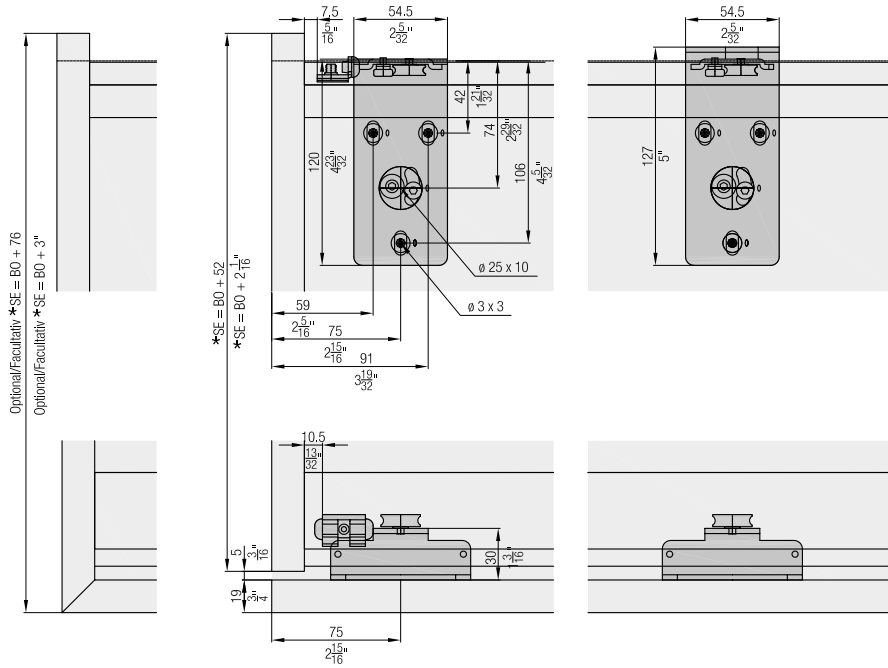
-  Max. 40 kg (88 lbs.)
-  Max. 1500 mm (4'11 1/16")
-  Max. 800 mm (2'7 15/32")
-  19 mm (3/4")



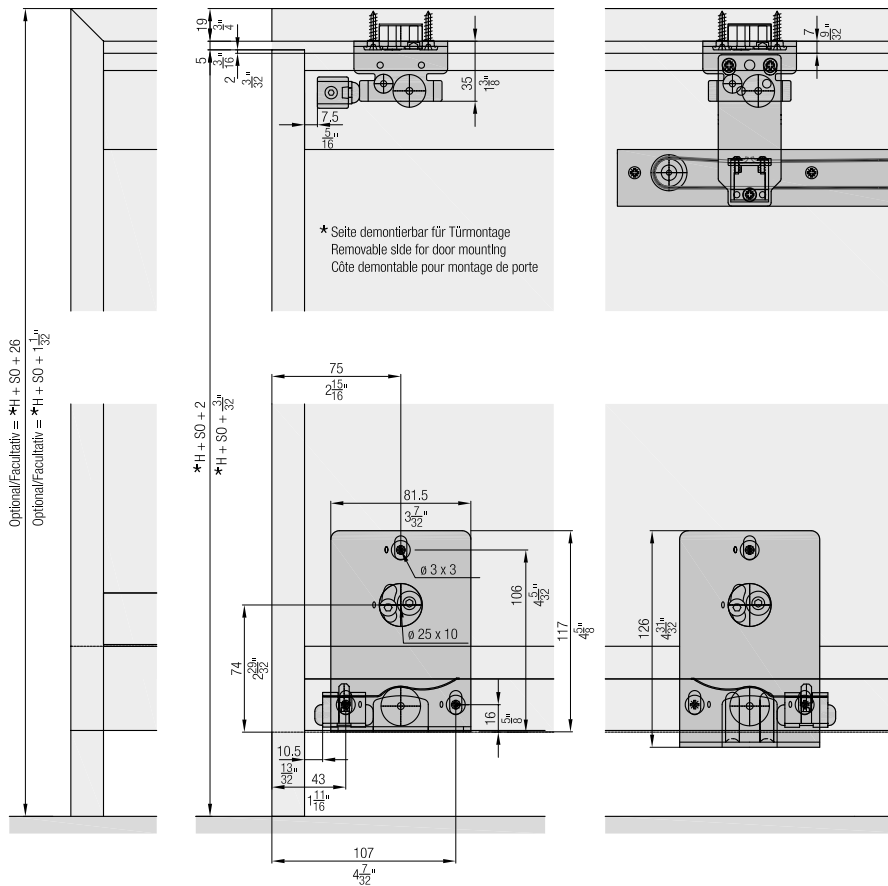
Installation examples



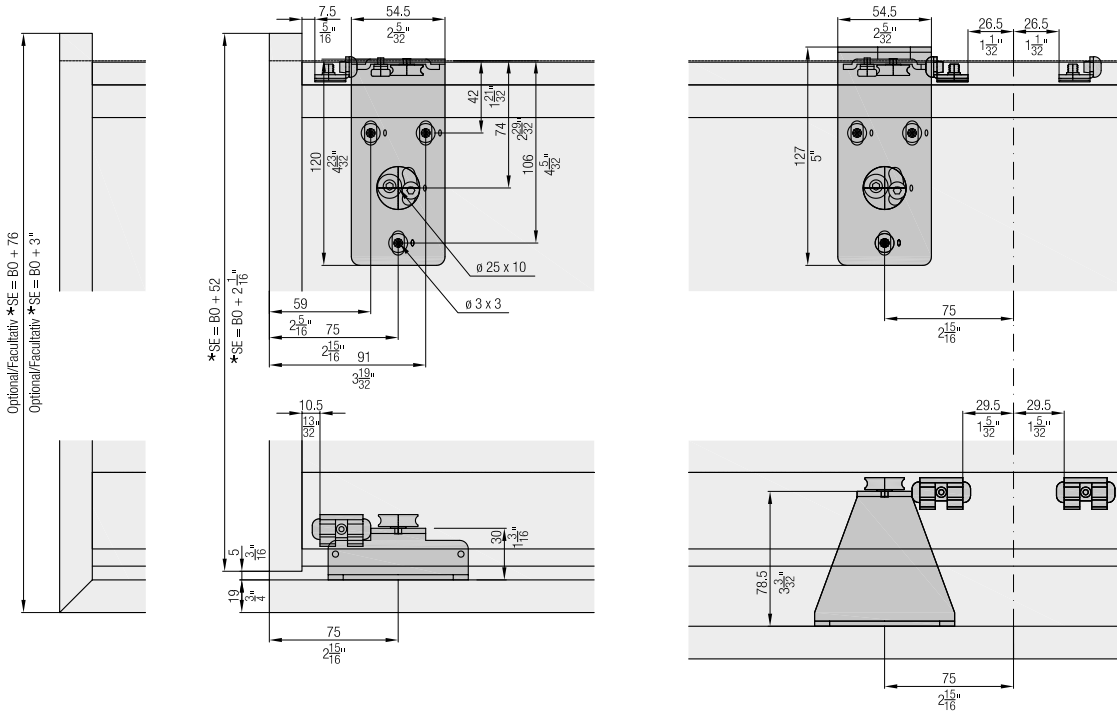
From above/2 wooden doors



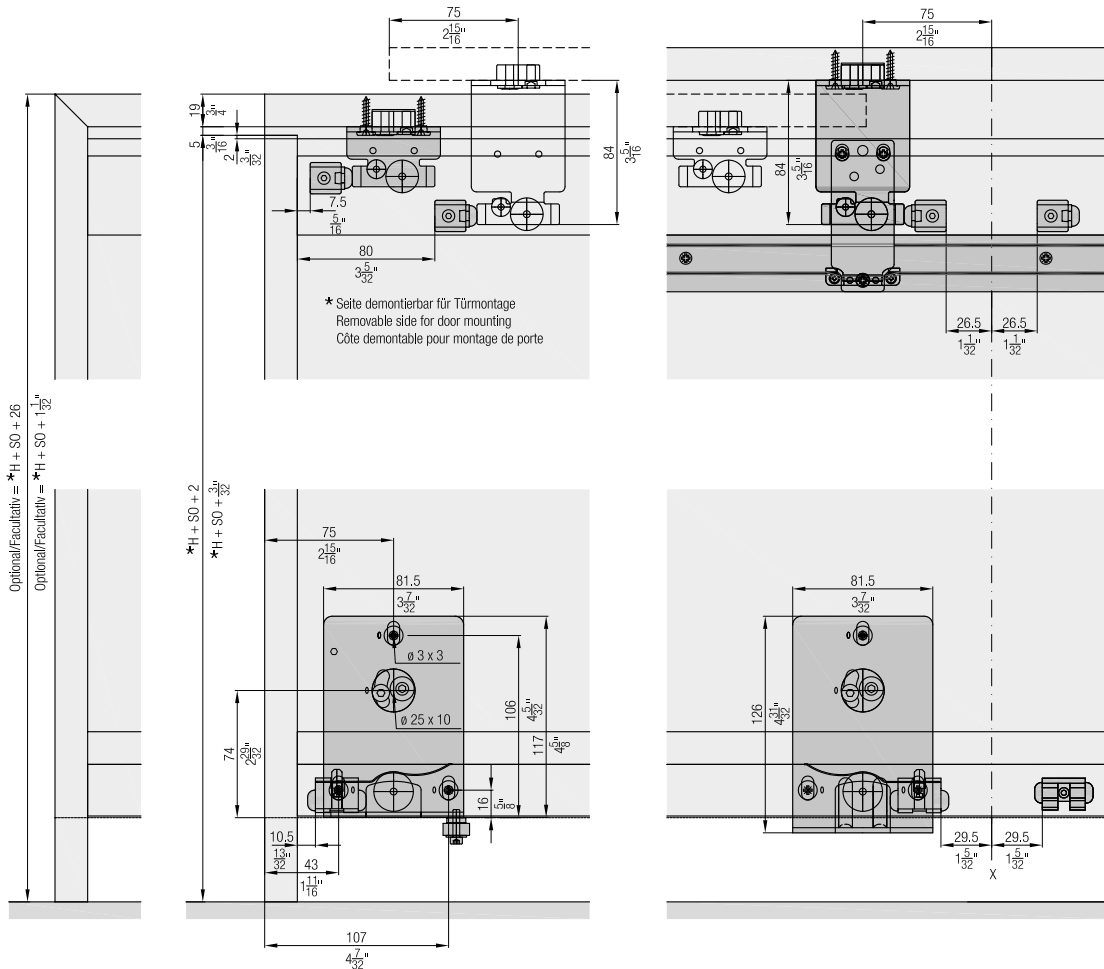
From front/2 wooden doors



From above/4 wooden doors



From front/4 wooden doors



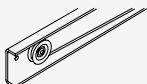




Set for 1 or 2 wooden doors
Always order 2 sets.

	No.
Hawa Combino L 40 H FS, for 1 wooden door	056.3160.071
Hawa Combino L 40 H FS, for 2 wooden doors	056.3160.072

Set consisting of:	056.3160.071		056.3160.072		No.
 Running gear, interior door, steel, zinc-plated	2	2			056.3155.171
 Guide bracket, interior door, steel, zinc-plated	2	2			056.3157.171
 Stopper, plastic, gray	2	4			056.3151.071
 Catch spring, steel	2	2			056.0174.001
 Stopper, steel, zinc-plated	2	4			056.3150.171
 Washer-and-screw assembly, 4.5x17 mm, steel, zinc-plated	12	24			055.0100.101
 Wood screw, 3.5x17 mm, steel, zinc-plated	16	16			766.6052.100
 Running gear, exterior door, steel, zinc-plated			2		056.3154.171
 Guide bracket, exterior door, steel, zinc-plated			2		056.3156.171
 Door follower, with 2-3 doors			1		056.3162.171

Synchro set

	No.
Hawa Combino L 40 H FS Synchrono	056.3173.071

Set consisting of:	056.3173.071		No.
 Symmetric track, aluminum	1		040.5044.171
 Adapter, for Symmetric track, steel, zinc-plated	2		056.0189.101
 Fillister head chipboard screw, 3.5x16 mm, steel, zinc-plated	8		766.6035.116
 Thread-cutting screw, M4x8, steel, zinc-plated	4		762.7007.108
 Countersunk screw, M4x10 mm, steel, zinc-plated	2		762.5003.100

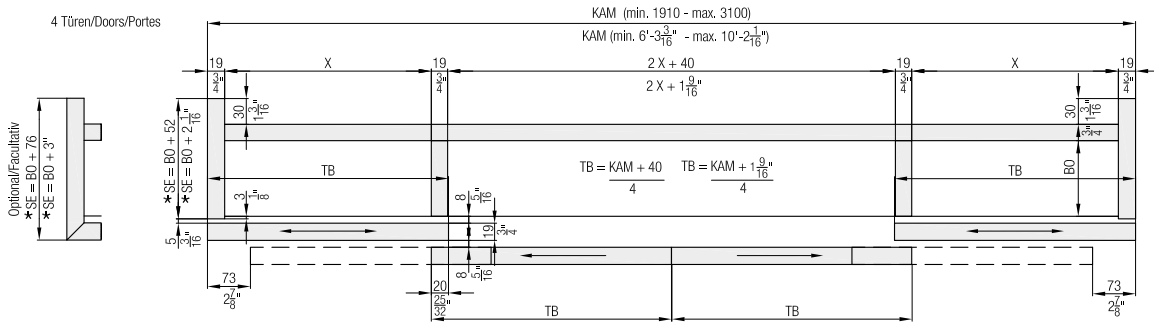
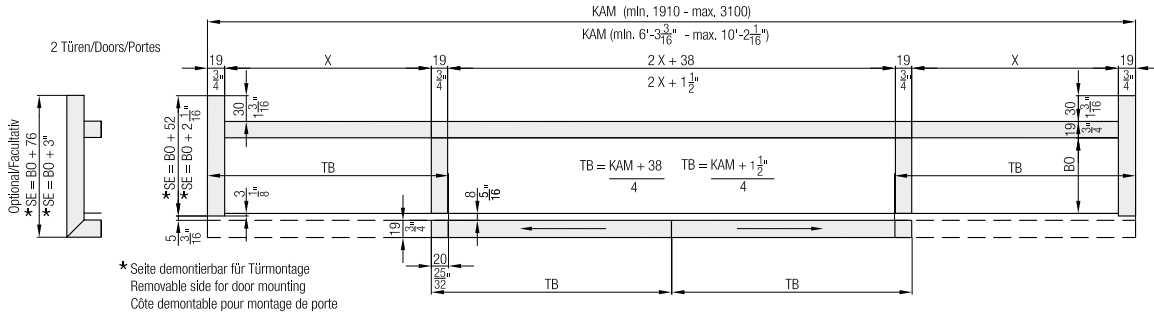
Running tracks

	mm (inch)	No.
	3500 (11'5 25/32")	056.3149.350
	6000 (19'8 7/32")	056.3149.600

Guide tracks

	mm (inch)	No.
	3500 (11'5 25/32")	056.3148.350
	6000 (19'8 7/32")	056.3148.600

Calculations



Accessories

– Straightening fitting from page 236

Planning/execution

Further information about the product can be found on www.hawa.com.

Hawa Clipo for wooden sliding doors One fitting, countless options

It doesn't matter whether you are installing one, two or three wooden doors in your furniture, whether these doors run inside or in front of the cabinet, or whether you are planning a stylish kitchen cabinet, serving hatch or service counter: The ideal Hawa Clipo version is available for all. Precisely coordinated to the weight of the door in versions for 15, 16, 26 or 36 kg. And with suitable soft closing performance for any weight class, which also increases the degree of sliding convenience, which is already high to begin with.





Regarding comfort: You also benefit from this during installation. You can choose whether you glue, screw on, caulk, groove mount or surface mount the running tracks. The door leaf and the running gear are connected without tools using a clip-on system. And height adjustment, e.g., is child's play with the well-tried, tool-less thumb wheel adjuster for Hawa Clipo 15 and 16.





Area of application

In offices, dining rooms or bedrooms, e.g. for sideboards and other occasional furniture, highboards as room partitions, wall units and base units in kitchens and bathrooms, wall cabinets and much more.

System advantages

-  **Flexibility** **Wide range of design and installation versions**, also thanks to combination of hardware components
-  **Productivity** **Easy installation** with tool-less clip-on system and convenient height adjustment
-  **Comfort** **Smooth, soft running**
Invisible soft closing mechanism, integrated in running track
-  **Aesthetics** **Flexible design options** with doors running inside and in front of the cabinet

Technical specifications

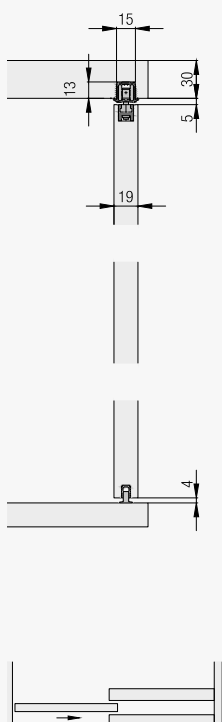
-  max. 15/16/26/36 kg
-  max. 2400 mm
-  max. 1200 mm
-  16–25 mm

Good to know (accessories)

- Hawa Soft closing mechanism
- Straightening fitting for doors
- Various handles

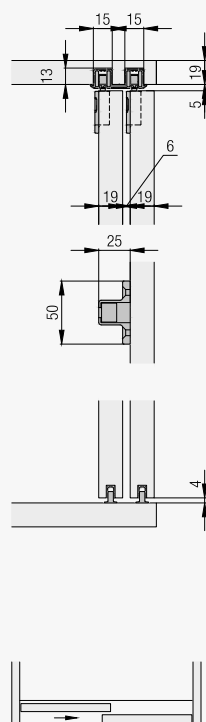
Installation examples

Hawa Clipo 16 HM IS



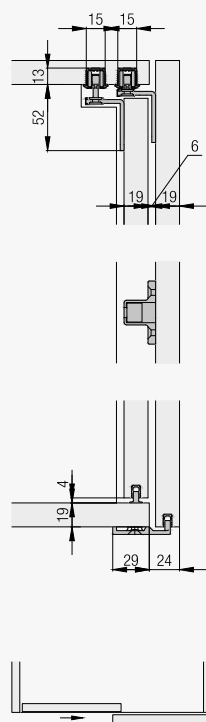
Product range
Hawa Clipo 16 HM IS
Hawa Clipo 36 HM IS

Hawa Clipo 16 H IS



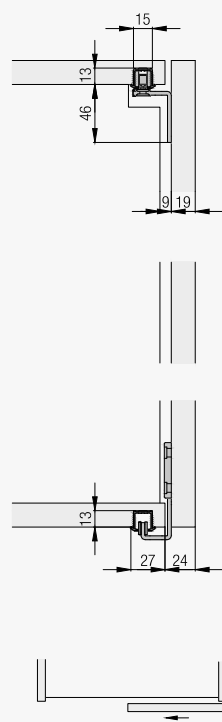
Hawa Clipo 15 H IS
Hawa Clipo 16 H IS
Hawa Clipo 26 H IS
Hawa Clipo 36 H IS

Hawa Clipo 16 H IS/FS



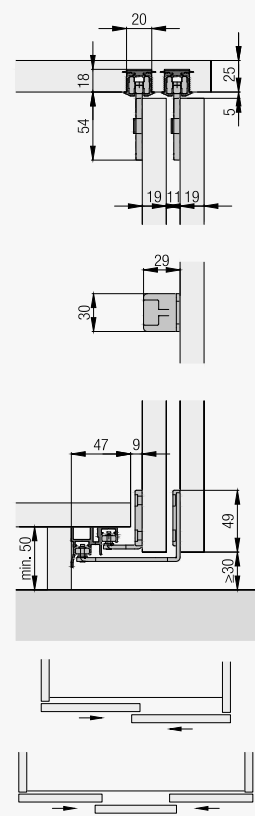
Hawa Clipo 16 H IS/FS

Hawa Clipo 16 H FS



Hawa Clipo 15 H FS
Hawa Clipo 16 H FS



Hawa Clipo 26 H MS







Hawa Clipo 15 H MS
Hawa Clipo 16 H MS
Hawa Clipo 26 H MS
Hawa Clipo 36 H MS

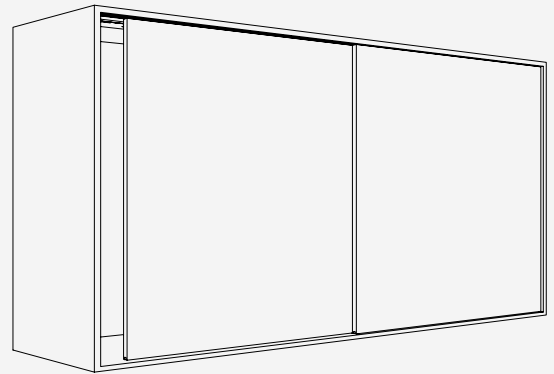
Fitting for 2 top-running wooden doors up to 15 kg (33 lbs.), with screwed on or groove mounted running track. Design Inside.

Product highlights

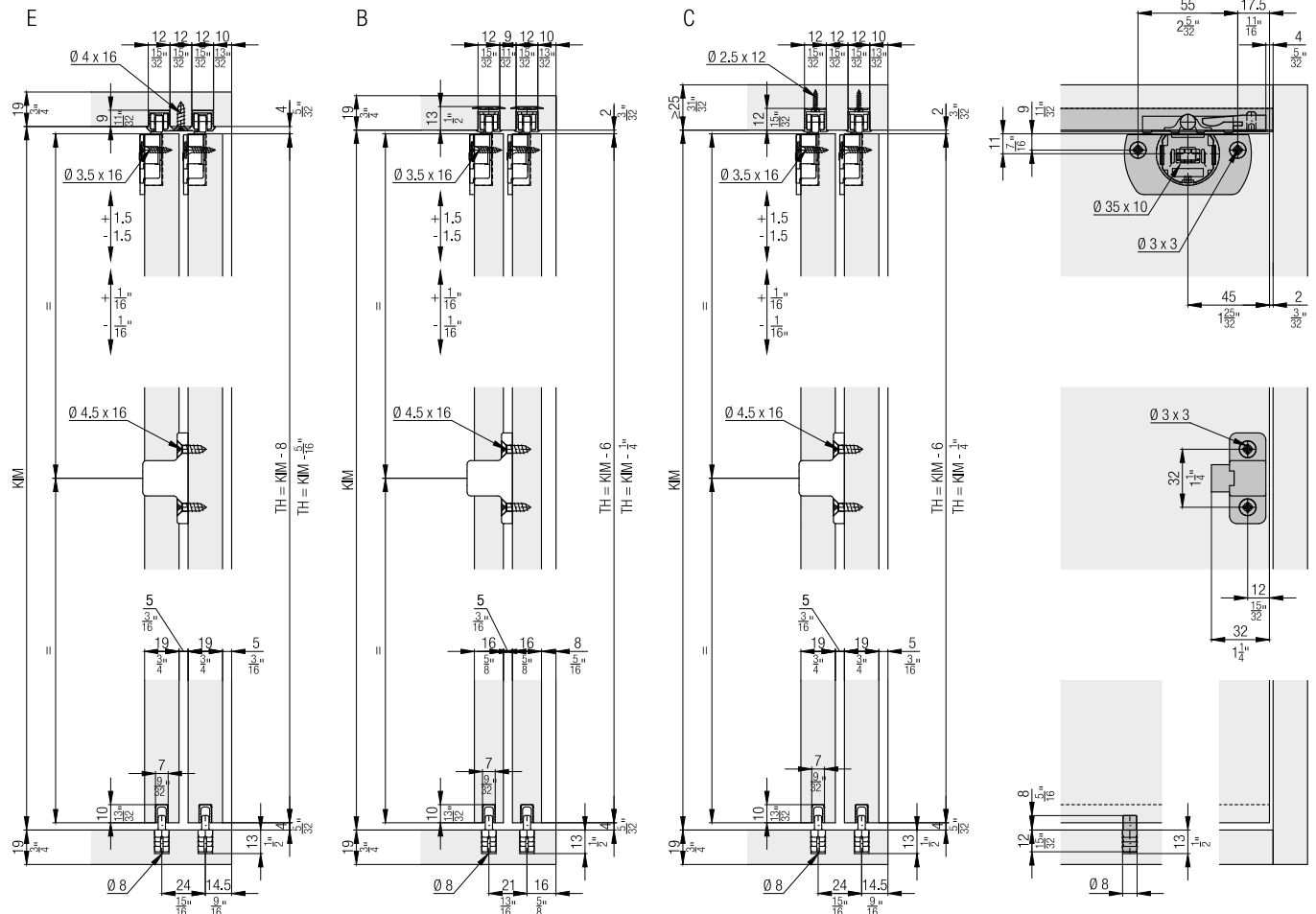
-  **Flexibility** Flexible, efficient assembly with single or double running tracks for screw fixing, gluing, or with swivel lugs
-  **Productivity** Efficient thanks to tool-less door installation as well as easy, intuitive adjustment

Technical specifications

-  Max. 15 kg (33 lbs.)
-  Max. 1400 mm (4'7 1/8")
-  Max. 1000 mm (3'3 3/8")
-  16–19 mm (5/8" to 3/4")



Installation examples



**Set for 2 wooden doors up to 15 kg (33 lbs.),
with height adjustment**

	No.
Hawa Clipo 15 H IS, for 2 doors	053.3115.071

Set consisting of:

		053.3115.071	No.
	Running gear, plastic, anthracite	4	053.3114.071
	Stopper, plastic, gray	2	053.3080.071
	Track support clip, plastic, gray	2	053.3087.001
	Housing, plastic, anthracite	4	053.3112.001
	Fillister head screw, 3.5x16 mm (5/32"x5/8"), steel, zinc-plated	8	766.6052.100
	Door follower, plastic, anthracite	1	053.3217.071
	Flat countersunk head chipboard screw, 4.5x16 mm (3/16"x5/8"), steel, zinc-plated	2	600.0000.478
	Bottom guide, plastic, anthracite	2	053.3013.001

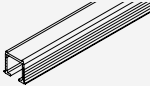
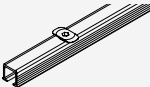
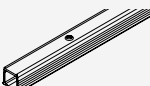

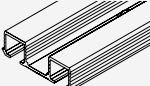
**Set for 2 wooden doors up to 15 kg (33 lbs.), without height
adjustment**

	No.
Hawa Clipo 15 H IS, without height adjustment, for 2 doors	053.3115.072

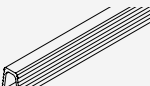
Set consisting of:

		053.3115.072	No.
	Running gear, without height adjustment, plastic, anthracite	4	053.3318.071
	Stopper, plastic, gray	2	053.3080.071
	Track support clip, plastic, gray	2	053.3087.001
	Housing, plastic, anthracite	4	053.3112.001
	Fillister head screw, 3.5x16 mm (5/32"x5/8"), steel, zinc-plated	8	766.6052.100
	Door follower, plastic, anthracite	1	053.3217.071
	Flat countersunk head chipboard screw, 4.5x16 mm (3/16"x5/8"), steel, zinc-plated	2	600.0000.478
	Bottom guide, plastic, anthracite	2	053.3013.001

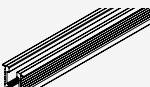
Running tracks

		mm (inch)	No.
	A: Single running track, for press fitting or glueing, aluminum	2,500 (8' 2 7/16")	053.3007.250
		3,500 (11' 5 25/32")	053.3007.350
		6,000 (19' 8 7/32")	053.3007.600
	B: Single running track, with swivel lug, notched on both sides, aluminum (not for hard wood/MDF)	2,500 (8' 2 7/16")	053.3008.250
		3,500 (11' 5 25/32")	053.3008.350
	B: Single running track, with swivel lug, aluminum (not for hard wood/MDF)	6,000 (19' 8 7/32")	053.3008.600
	C: Single running track, notched on both sides, aluminum, pre-drilled	2,500 (8' 2 7/16")	053.3009.250
		3,500 (11' 5 25/32")	053.3009.350
	C: Single running track, aluminum, pre-drilled	6,000 (19' 8 7/32")	053.3009.600
	D: Single running track, aluminum, anodized, pre-drilled	2,500 (8' 2 7/16")	053.3035.250
		3,500 (11' 5 25/32")	053.3035.350
		6,000 (19' 8 7/32")	053.3035.600
	E: Double running track, aluminum, pre-drilled, only for 19 mm (3/4") doors	2,500 (8' 2 7/16")	053.3315.250
		3,500 (11' 5 25/32")	053.3315.350
	E: Double running track, aluminum, pre-drilled, only for 19 mm (3/4") doors	6,000 (19' 8 7/32")	053.3315.600



Guide tracks

		mm (inch)	No.
	Guide track, groove width 7 mm (9/32"), plastic, anthracite	2,500 (8' 2 7/16")	053.3012.250
		3,500 (11' 5 25/32")	053.3012.350
		6,000 (19' 8 7/32")	053.3012.600

Guide tracks 4-point guidance




		mm (inch)	No.
	Single guide track, for glue fixing, aluminum, anodized	6,000 (19' 8 7/32")	053.3296.600

Components 4-point guidance



		No.
	Bottom guide Hawa Clipo IS/ Hawa Regal C 16, plastic, anthracite	040.3124.071
	Stopper guide track, plastic, grey	053.5094.071

Door centering

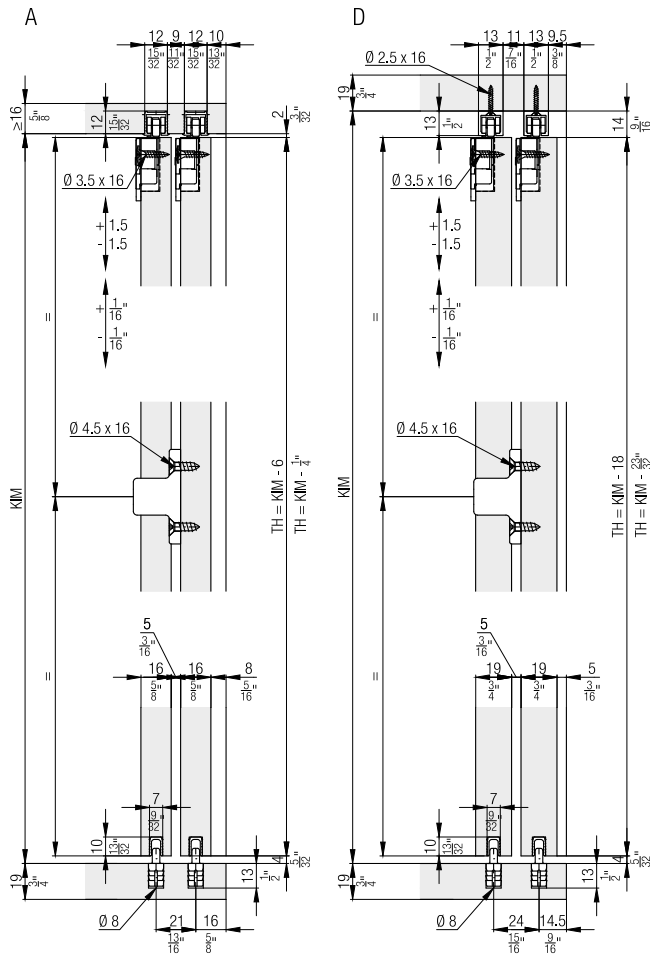
	No.
Door centering, plastic, anthracite, for 2 doors	053.3207.071

	053.3207.071	No.
Set consisting of:		
	2	053.5014.001
	2	053.0171.001
	1	025.0107.001

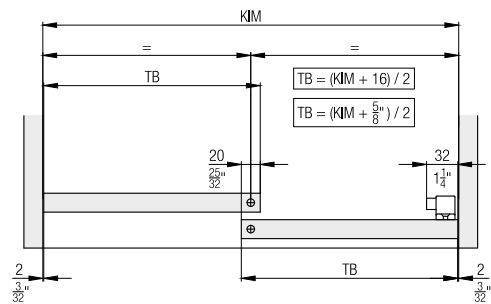
Accessories

		No.
	Housing Hawa Clipo 15, press-fit, plastic, anthracite	083.3009.001
	Track cleaner, plastic, red	040.3142.071

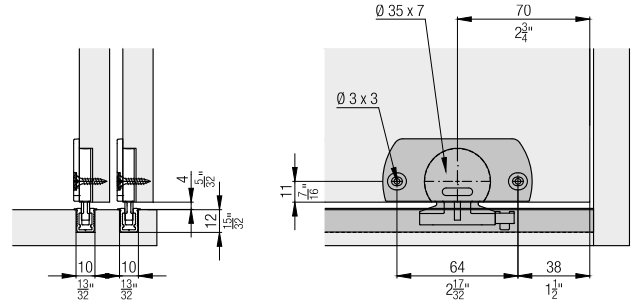
Further installation examples



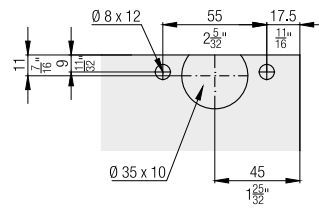
Calculations



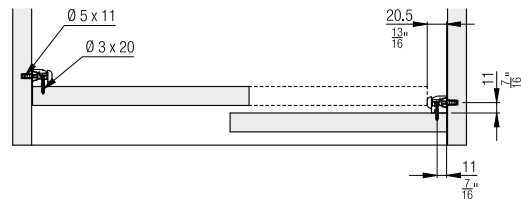
4 point guidance



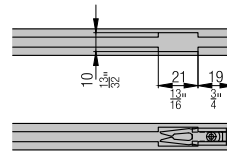
Housing for press-fitting



Door centering



Notched track



Accessories



– Straightening fitting from page 236

Planning/execution


Further information about the product can be found on www.hawa.com.

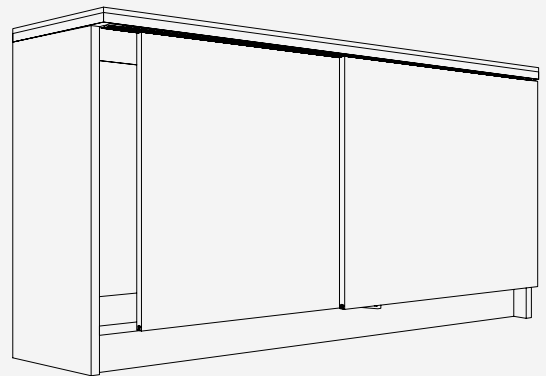
Fitting for 2 top-running wooden doors up to 15 kg (33 lbs.), with screwed on or groove mounted running track. Design Mixslide.

Product highlights

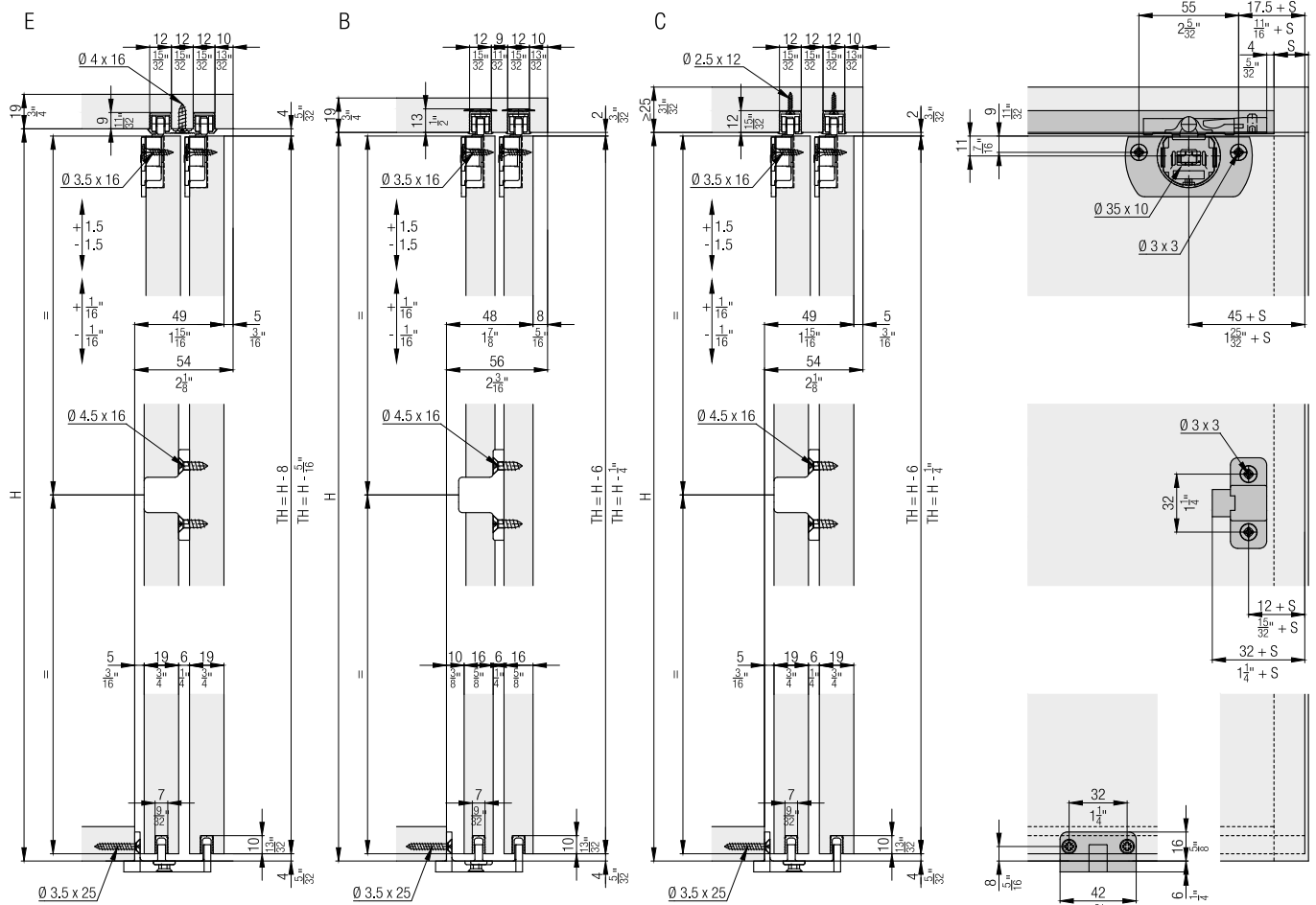
-  **Flexibility** Flexible, efficient assembly with single or double running tracks for screw fixing, gluing, or with swivel lugs
-  **Aesthetics** No groove in the base, and no visible guide

Technical specifications

-  Max. 15 kg (33 lbs.)
-  Max. 1400 mm (4'7 1/8")
-  Max. 1000 mm (3'3 3/8")
-  16–19 mm (5/8" to 3/4")












Installation examples



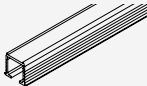
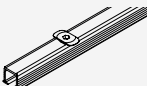
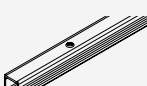

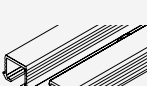
Set for 2 wooden doors up to 15 kg (33 lbs.), with height adjustment

	No.
Hawa Clipo 15 H MS, for 2 doors	053.3115.073

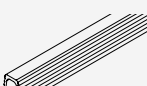
Set consisting of:

		053.3115.073	No.
	Running gear, plastic, anthracite	4	053.3114.071
	Stopper, plastic, gray	2	053.3080.071
	Track support clip, plastic, gray	2	053.3087.001
	Housing, plastic, anthracite	4	053.3112.001
	Fillister head screw, 3.5x16 mm (5/32"x5/8"), steel, zinc-plated	8	766.6052.100
	Door follower, plastic, anthracite	1	053.3217.071
	Flat countersunk head chipboard screw, 4.5x16 mm (3/16"x5/8"), steel, zinc-plated	2	600.0000.478
	Bottom guide, plastic, anthracite	1	053.3232.171
	Flat countersunk head chipboard screw, 3.5x25 mm (5/32"x31/32"), steel, zinc-plated	2	766.5035.125

Running tracks




		mm (inch)	No.
	A: Single running track, for press fitting or glueing, aluminum	2,500 (8' 2 7/16")	053.3007.250
		3,500 (11' 5 25/32")	053.3007.350
		6,000 (19' 8 7/32")	053.3007.600
	B: Single running track, with swivel lug, notched on both sides, aluminum (not for hard wood/MDF)	2,500 (8' 2 7/16")	053.3008.250
		3,500 (11' 5 25/32")	053.3008.350
	B: Single running track, with swivel lug, aluminum (not for hard wood/MDF)	6,000 (19' 8 7/32")	053.3008.600
	C: Single running track, notched on both sides, aluminum, pre-drilled	2,500 (8' 2 7/16")	053.3009.250
		3,500 (11' 5 25/32")	053.3009.350
	C: Single running track, aluminum, pre-drilled	6,000 (19' 8 7/32")	053.3009.600
	D: Single running track, aluminum, anodized, pre-drilled	2,500 (8' 2 7/16")	053.3035.250
		3,500 (11' 5 25/32")	053.3035.350
		6,000 (19' 8 7/32")	053.3035.600
	E: Double running track, aluminum, pre-drilled, only for 19 mm (3/4") doors	2,500 (8' 2 7/16")	053.3315.250
		3,500 (11' 5 25/32")	053.3315.350
	E: Double running track, aluminum, pre-drilled, only for 19 mm (3/4") doors	6,000 (19' 8 7/32")	053.3315.600

Guide tracks

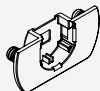

		mm (inch)	No.
	Guide track, groove width 7 mm (9/32"), plastic, anthracite	2,500 (8' 2 7/16")	053.3012.250
		3,500 (11' 5 25/32")	053.3012.350
		6,000 (19' 8 7/32")	053.3012.600

Door centering

	No.
Door centering, plastic, anthracite, for 2 doors	053.3207.071

		053.3207.071	No.
Set consisting of:			
	Housing door centering, plastic, anthracite	2	053.5014.001
	Pin door centering, plastic, anthracite	2	053.0171.001
	Rubber buffer, plastic, grey	1	025.0107.001

Accessories

		No.
	Housing Hawa Clipo 15, press-fit, plastic, anthracite	083.3009.001
	Track cleaner, plastic, red	040.3142.071

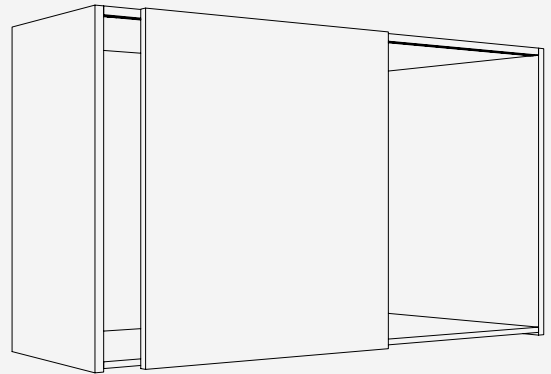
Fitting for 1 top-running wooden door up to 15 kg (33 lbs.), with screwed on or groove mounted running track. Design Forslide.

Product highlights

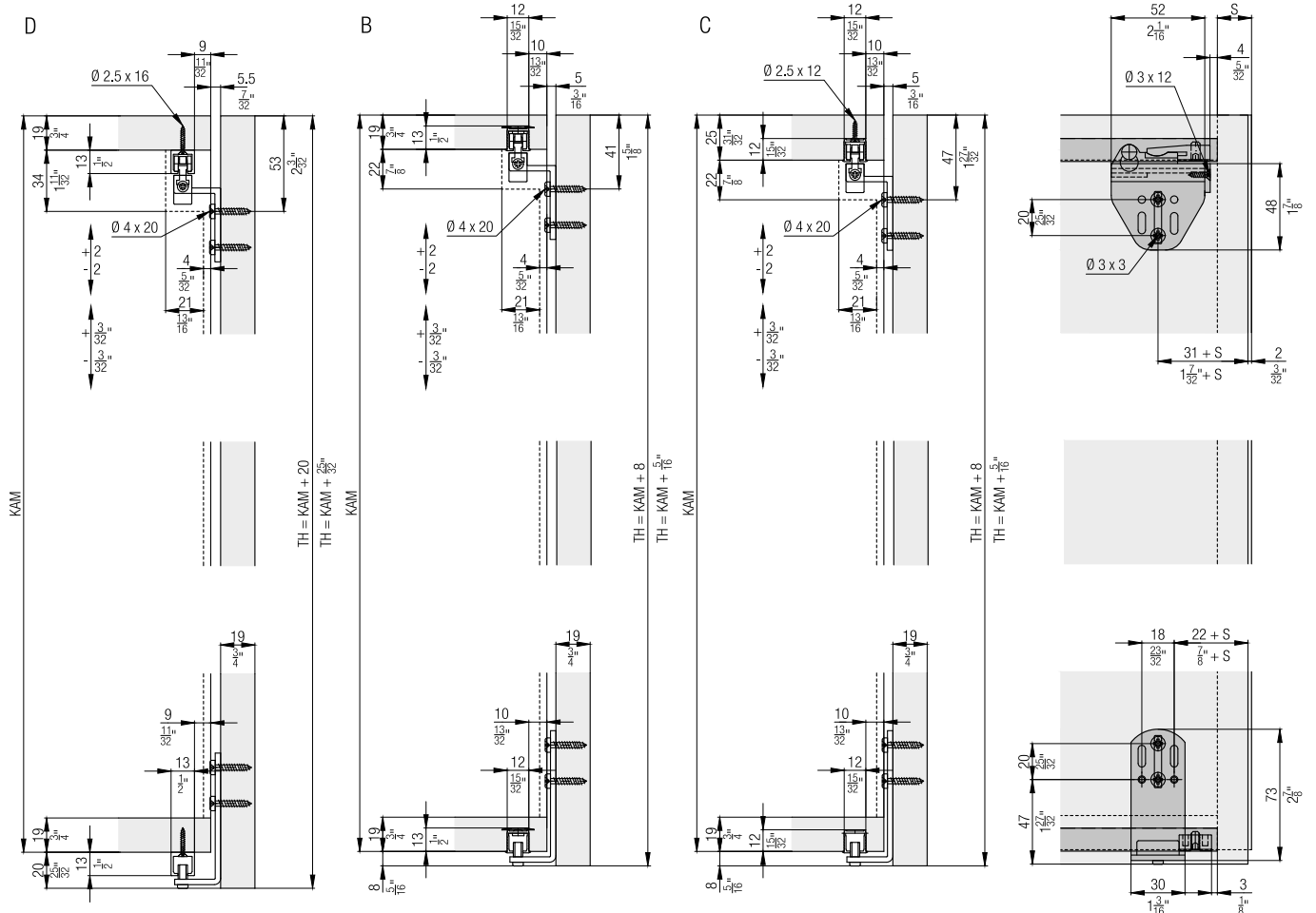
- Flexibility** Flexible, efficient assembly with single running tracks for screw fixing, gluing, or with swivel lugs
- Aesthetics** Elegant, single door solution with invisible running system

Technical specifications

- Max. 15 kg (33 lbs.)
- Max. 1400 mm (4'7 1/8")
- Max. 1000 mm (3'3 3/8")
- 19–25 mm (3/4" to 31/32")



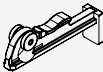






Installation examples



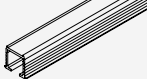
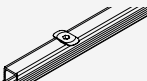
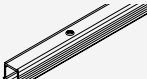

Set for 1 wooden door up to 15 kg (33 lbs.), with height adjustment

	No.
Hawa Clipo 15 H FS, for 1 door	053.3051.071

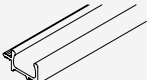

Set consisting of:

		053.3051.071	No.
	Running gear, to slide in	2	053.3032.071
	Flat countersunk head chipboard screw, 3x12 mm (1/8"x15/32"), steel, zinc-plated	2	766.5030.112
	Stopper, plastic, gray	2	053.3080.071
	Track support clip, plastic, gray	1	053.3087.001
	Housing for wooden doors, to screw fixing, aluminum	2	053.3048.002
	Angle plate guide, steel, zinc-plated	2	053.3050.172
	Stopper to guide angle, plastic, gray	2	053.3092.001


Running tracks

		mm (inch)	No.
	A: Single running track, for press fitting or glueing, aluminum	2,500 (8' 2 7/16")	053.3007.250
		3,500 (11' 5 25/32")	053.3007.350
		6,000 (19' 8 7/32")	053.3007.600
	B: Single running track, with swivel lug, notched on both sides, aluminum (not for hard wood/MDF)	2,500 (8' 2 7/16")	053.3008.250
		3,500 (11' 5 25/32")	053.3008.350
		6,000 (19' 8 7/32")	053.3008.600
	C: Single running track, notched on both sides, aluminum, pre-drilled	2,500 (8' 2 7/16")	053.3009.250
		3,500 (11' 5 25/32")	053.3009.350
	C: Single running track, aluminum, pre-drilled	6,000 (19' 8 7/32")	053.3009.600
	D: Single running track, aluminum, anodized, pre-drilled	2,500 (8' 2 7/16")	053.3035.250
		3,500 (11' 5 25/32")	053.3035.350
		6,000 (19' 8 7/32")	053.3035.600

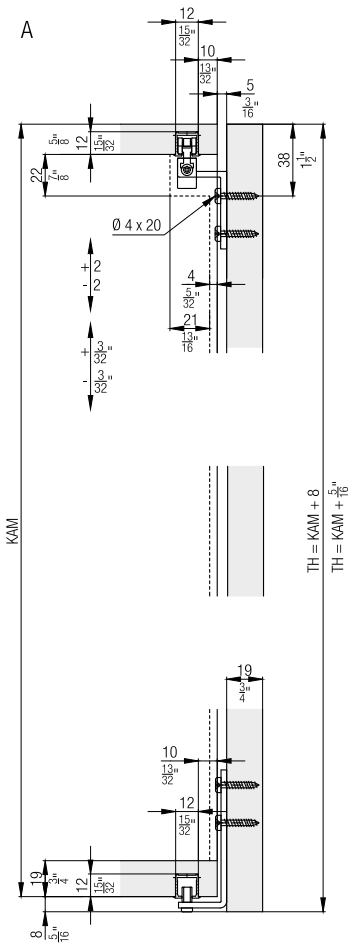
Handle profiles

		mm (inch)	No.
	Handle profile, groove for brush seal, for groove mounting, aluminum, anodized, for door thickness of 19 mm (3/4")	2,500 (8' 2 7/16")	056.3028.250
		6,000 (19' 8 7/32")	056.3028.600
	Handle profile, groove for brush seal, for screw fixing, aluminum, anodized, pre-drilled	2,500 (8' 2 7/16")	055.3140.250
		6,000 (19' 8 7/32")	055.3140.600

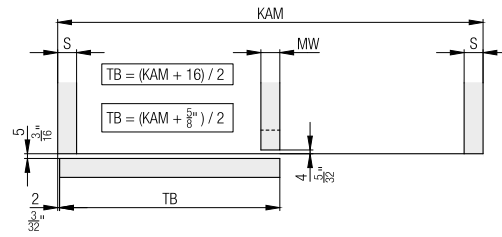
Accessories

		No.
	Track cleaner, plastic, red	040.3142.071

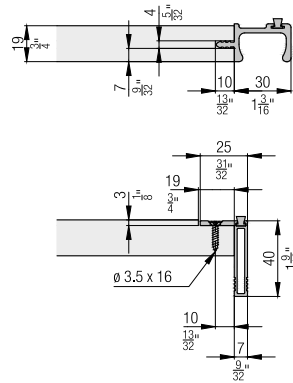
Further installation examples



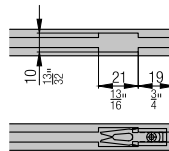
Calculations



Handle profiles



Notched track



Accessories



– Straightening fitting from page 236

Planning/execution





Further information about the product can be found on www.hawa.com.

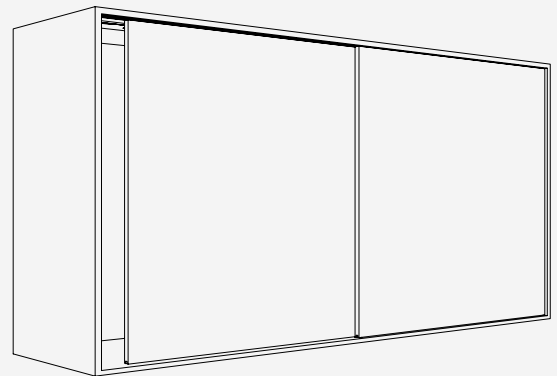
Fitting for 2 top-running wooden doors up to 16 kg (35 lbs.), with screwed on or groove mounted running track. With soft and self closing mechanism. Design Inside.

Product highlights

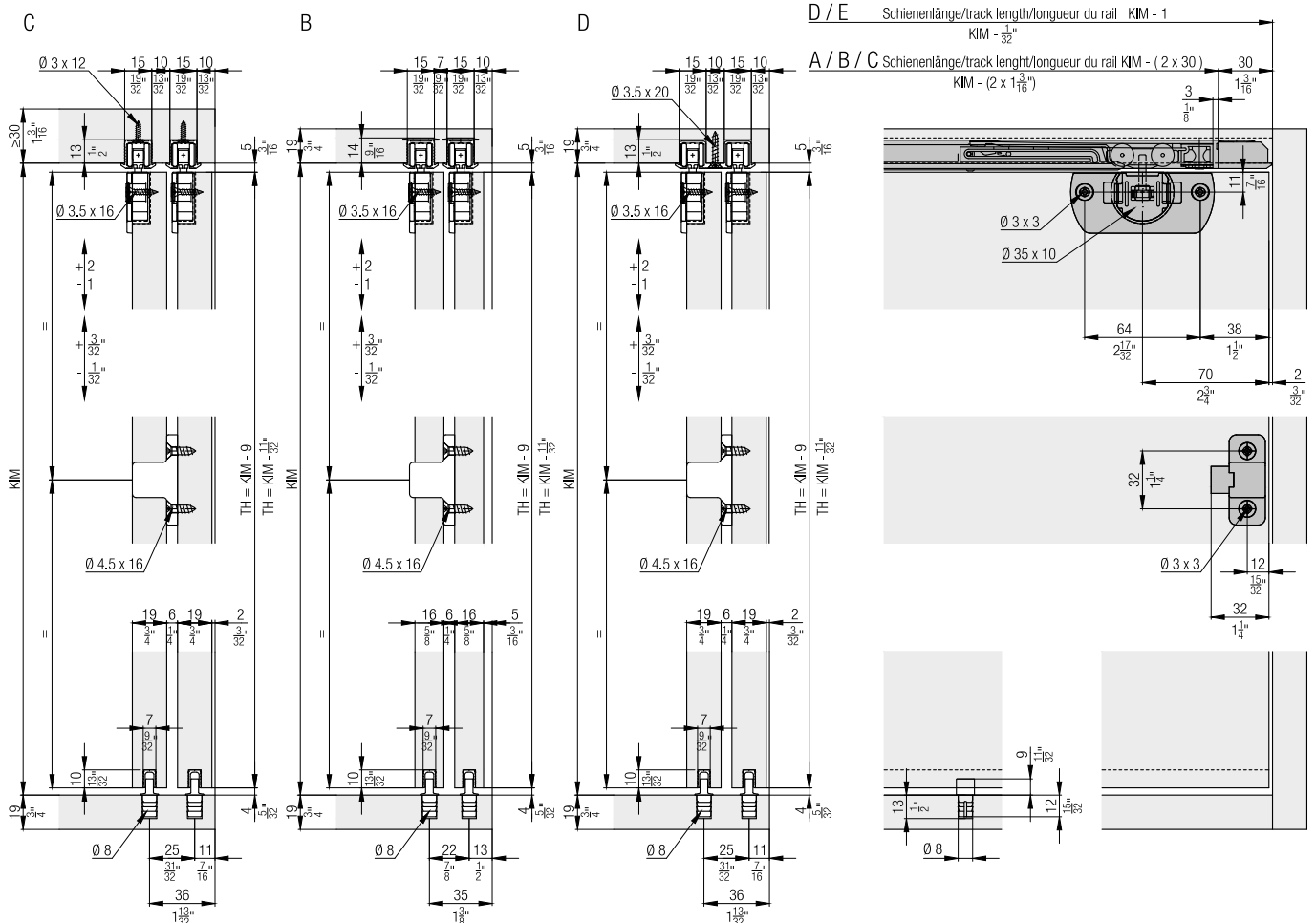
-  **Comfort** Smooth, silent running with Comfort Roller and soft and self closing system for different door weights
-  **Productivity** Efficient thanks to tool-less door installation as well as easy, intuitive adjustment

Technical specifications

-  Max. 16 kg (35 lbs.)
-  Max. 1400 mm (4'7 1/8")
-  Max. 1000 mm (3'3 3/8")
-  16–19 mm (5/8" to 3/4")










Installation examples



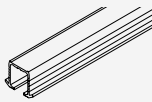
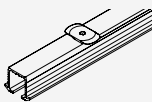
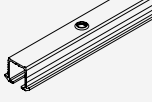
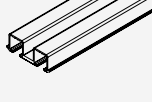
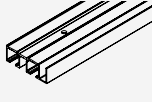
**Set for 2 wooden doors up to 16 kg (35 lbs.),
with height adjustment**

	No.
Hawa Clipo 16 H IS, for 2 doors	053.3220.071

Set consisting of:



		053.3220.071	No.
	Hawa Clipo 16 H/Hawa Regal 16 C running gear, plastic, anthracite	4	053.3205.071
	Hawa Clipo 16/Hawa Regal 16 C stopper, plastic, gray	2	053.3215.071
	Housing, plastic, anthracite	4	053.0183.001
	Fillister head screw, 3.5x16 mm (5/32"x5/8"), steel, zinc-plated	8	766.6052.100
	Door follower, plastic, anthracite	1	053.3217.071
	Flat countersunk head chipboard screw, 4.5x16 mm (3/16"x5/8"), steel, zinc-plated	2	600.0000.478
	Hawa Clipo 16 H bottom guide, plastic, anthracite	2	053.3214.001

Running tracks

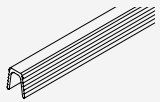
		mm (inch)	No.
	A: Single running track, for glue fixing, aluminum	2,500 (8' 2 7/16")	053.3229.250
		3,500 (11' 5 25/32")	053.3229.350
		6,000 (19' 8 7/32")	053.3229.600
	B: Single running track, with swivel-lug, aluminum (not for hard wood/MDF)	2,500 (8' 2 7/16")	053.3227.250
		3,500 (11' 5 25/32")	053.3227.350
		6,000 (19' 8 7/32")	053.3227.600
	C: Single running track, aluminum, pre-drilled	2,500 (8' 2 7/16")	053.3225.250
		3,500 (11' 5 25/32")	053.3225.350
		6,000 (19' 8 7/32")	053.3225.600
	D: Double running track, aluminum, pre-drilled	2,500 (8' 2 7/16")	053.3226.250
		3,500 (11' 5 25/32")	053.3226.350
		6,000 (19' 8 7/32")	053.3226.600
	E: Double running track, aluminum, anodized, pre-drilled	2,500 (8' 2 7/16")	053.3231.250
		3,500 (11' 5 25/32")	053.3231.350
		6,000 (19' 8 7/32")	053.3231.600

Track end piece set for single running tracks

	No.
Track end piece, for screw fixing, plastic, gray	053.3210.081
Track end piece, with swivel lug, plastic, gray	053.3211.081

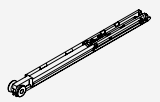
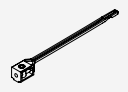

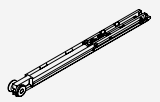
		053.3210.081	053.3211.081	No.
Set consisting of:				
	Track-end piece, for screw fixing, plastic, grey	2		053.3210.001
	Track-end piece, with swivel lug, plastic, grey		2	053.3211.071

Guide tracks

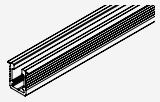
		mm (inch)	No.
	Guide track, groove width 7 mm (9/32"), plastic, anthracite	2,500 (8' 2 7/16")	053.3012.250
		3,500 (11' 5 25/32")	053.3012.350
		6,000 (19' 8 7/32")	053.3012.600

Soft close up to 8/16 kg (17/35 lbs.)

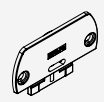

	No.
Soft close Hawa Clipo 16/Hawa Regal C 16, up to 8 kg (17 lbs.)	053.3332.071
Soft close Hawa Clipo 16/Hawa Regal C 16, up to 16 kg (35 lbs.)	053.3332.072

		053.3332.071	053.3332.072	No.
Set consisting of:				
	Damper, up to 8 kg (17 lbs.)	2		053.3330.071
	Trigger, with stopper	2	2	053.3331.071
	Cross recessed pan head screw, 2.2x8 mm (3/32"x5/16"), steel, zinc-plated	2	2	600.0000.482
	Damper, up to 16 kg (35 lbs.)		2	053.3330.072




Guide tracks 4-point guidance

		mm (inch)	No.
	Single guide track, for glue fixing, aluminum, anodized	6,000 (19' 8 7/32")	053.3296.600

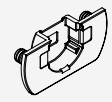

Components 4-point guidance

		No.
	Bottom guide Hawa Clipo IS/Hawa Regal C 16, plastic, anthracite	040.3124.071
	Stopper guide track, plastic, grey	053.5094.071

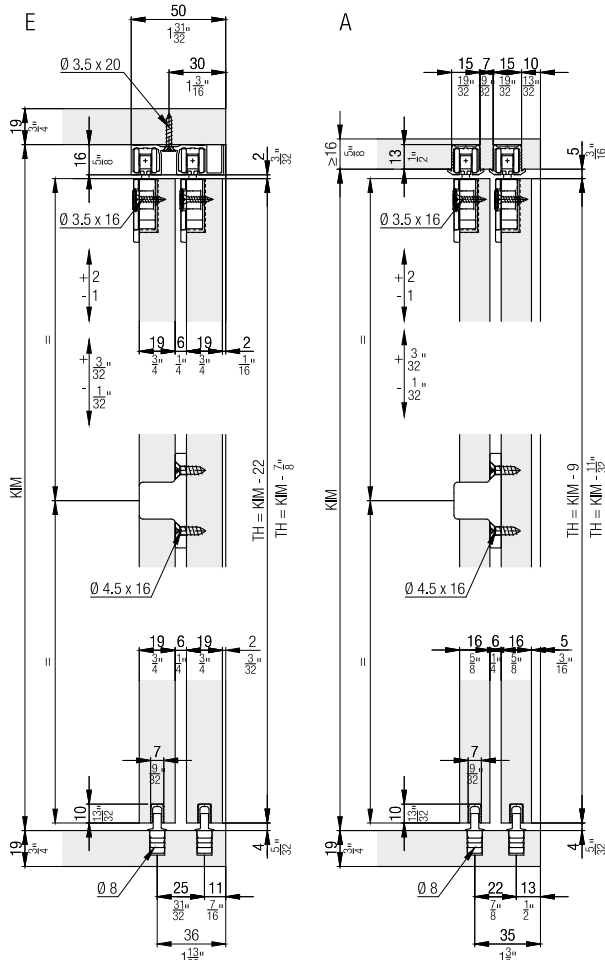
Door centering

		No.	
Door centering, plastic, anthracite, for 2 doors		053.3207.071	
		053.3207.071	No.
	Housing door centering, plastic, anthracite	2	053.5014.001
	Pin door centering, plastic, anthracite	2	053.0171.001
	Rubber buffer, plastic, grey	1	025.0107.001

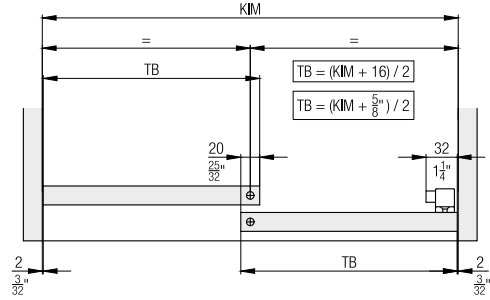
Accessories

		No.
	Housing Hawa Clipo 16, press-fit, plastic, anthracite	083.3009.002
	Track cleaner, plastic, red	040.3142.071

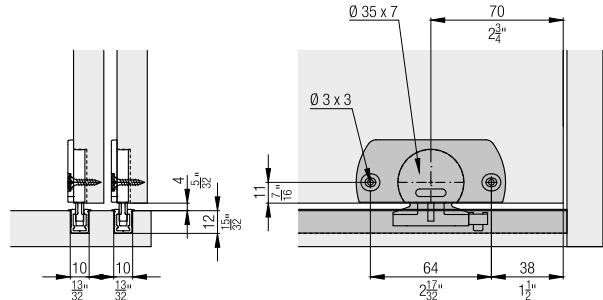
Further installation examples



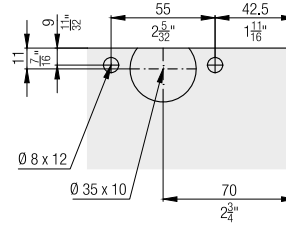
Calculations



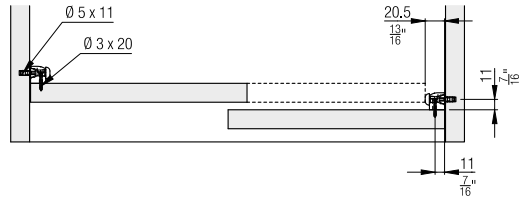
4 point guidance



Housing for press-fitting

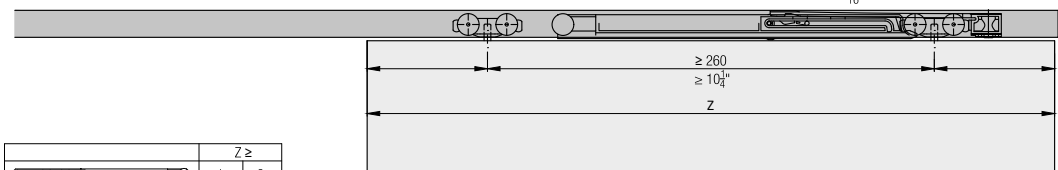


Door centering

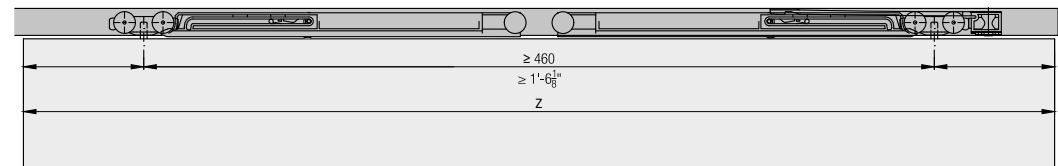
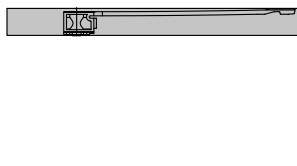


Soft close

	Z ≥	
	1	2
Hawa Clipo 16 H IS	1' 3 ³ / ₈ "	1' 11 ⁵ / ₈ "
Hawa Clipo 16 H MS	1' 5 ¹ / ₄ "	2' 1 ¹ / ₈ "
Hawa Clipo 16 H FS	1' 5 ¹ / ₄ "	2' 1 ¹ / ₈ "
Hawa Clipo 16 HM IS	1' 3 ³ / ₈ "	1' 11 ⁵ / ₈ "
Hawa Clipo 16 GK IS	1' 3 ³ / ₈ "	1' 11 ⁵ / ₈ "
Hawa Clipo 16 GS IS	1' 3 ³ / ₈ "	1' 11 ⁵ / ₈ "
Hawa Clipo 16 GPK IS	1' 3 ³ / ₈ "	1' 11 ⁵ / ₈ "
Hawa Clipo 16 GPPK IS	1' 3 ³ / ₈ "	1' 11 ⁵ / ₈ "



	Z ≥	
	1	2
Hawa Clipo 16 H IS	400	600
Hawa Clipo 16 H MS	438	638
Hawa Clipo 16 H FS	438	638
Hawa Clipo 16 HM IS	400	600
Hawa Clipo 16 GK IS	400	600
Hawa Clipo 16 GS IS	400	600
Hawa Clipo 16 GPK IS	400	600
Hawa Clipo 16 GPPK IS	400	600



Accessories



– Straightening fitting from page 236

Planning/execution

Further information about the product can be found on www.hawa.com.

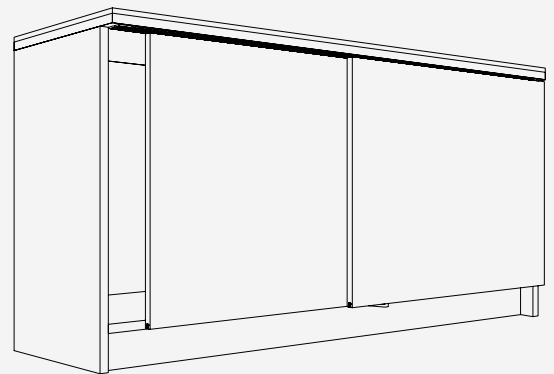
Fitting for 2 top-running wooden doors up to 16 kg (35 lbs.), with groove mounted running track. With soft and self closing mechanism. Design Mixslide.

Product highlights

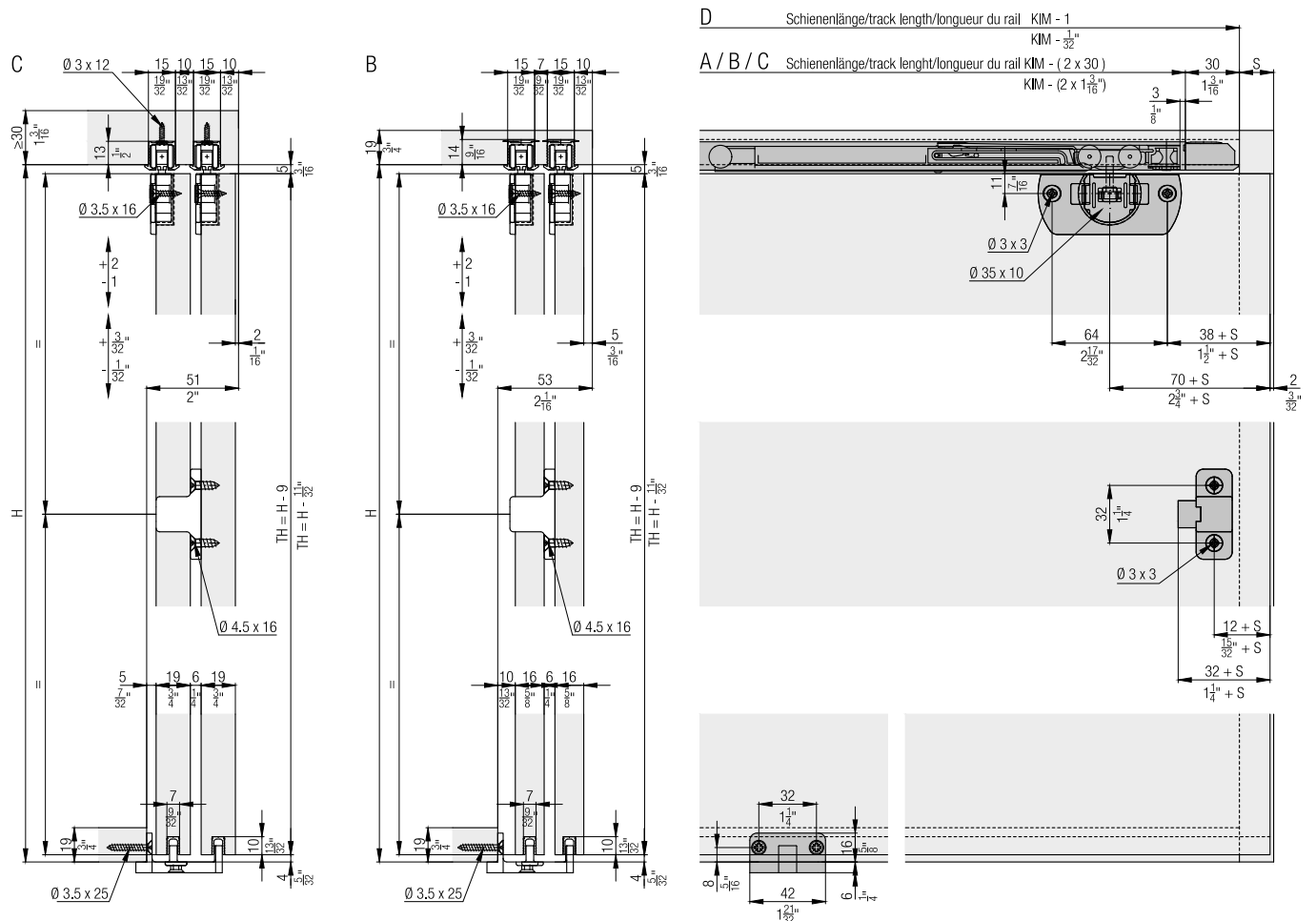
-  **Comfort** Smooth, silent running with Comfort Roller and soft and self closing system for different door weights
-  **Aesthetics** No groove in the base, and no visible guide

Technical specifications

-  Max. 16 kg (35 lbs.)
-  Max. 1400 mm (4'7 1/8")
-  Max. 1000 mm (3'3 3/8")
-  16-19 mm (5/8" to 3/4")



Installation examples



**Set for 2 wooden doors up to 16 kg (35 lbs.),
with height adjustment**

	No.
Hawa Clipo 16 H MS, for 2 doors	053.3221.071

Set consisting of:



		053.3221.071	No.
	Hawa Clipo 16 H/Hawa Regal 16 C running gear, plastic, anthracite	4	053.3205.071
	Hawa Clipo 16/Hawa Regal 16 C stopper, plastic, gray	2	053.3215.071
	Housing, plastic, anthracite	4	053.0183.001
	Fillister head screw, 3.5x16 mm (5/32"x5/8"), steel, zinc-plated	8	766.6052.100
	Door follower, plastic, anthracite	1	053.3217.071
	Flat countersunk head chipboard screw, 4.5x16 mm (3/16"x5/8"), steel, zinc-plated	2	600.0000.478
	Bottom guide, plastic, anthracite	1	053.3232.171
	Flat countersunk head chipboard screw, 3.5x25 mm (5/32"x31/32"), steel, zinc-plated	2	766.5035.125

Running tracks

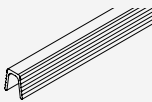
		mm (inch)	No.
	A: Single running track, for glue fixing, aluminum	2,500 (8' 2 7/16")	053.3229.250
		3,500 (11' 5 25/32")	053.3229.350
		6,000 (19' 8 7/32")	053.3229.600
	B: Single running track, with swivel-lug, aluminum (pas pour bois dur/MDF)	2,500 (8' 2 7/16")	053.3227.250
		3,500 (11' 5 25/32")	053.3227.350
		6,000 (19' 8 7/32")	053.3227.600
	C: Single running track, aluminum, pre-drilled	2,500 (8' 2 7/16")	053.3225.250
		3,500 (11' 5 25/32")	053.3225.350
		6,000 (19' 8 7/32")	053.3225.600
	D: Double running track, aluminum, pre-drilled	2,500 (8' 2 7/16")	053.3226.250
		3,500 (11' 5 25/32")	053.3226.350
		6,000 (19' 8 7/32")	053.3226.600

Track end piece set for single running tracks

	No.
Track end piece, for screw fixing, plastic, gray	053.3210.081
Track end piece, with swivel lug, plastic, gray	053.3211.081

		053.3210.081	053.3211.081	No.
	Track-end piece, for screw fixing, plastic, grey	2		053.3210.001
	Track-end piece, with swivel lug, plastic, grey		2	053.3211.071

Guide tracks

		mm (inch)	No.
	Guide track, groove width 7 mm (9/32"), plastic, anthracite	2,500 (8' 2 7/16")	053.3012.250
		3,500 (11' 5 25/32")	053.3012.350
		6,000 (19' 8 7/32")	053.3012.600

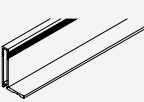
Soft close up to 8/16 kg (17/35 lbs.)

	No.
Soft close Hawa Clipo 16/Hawa Regal C 16, up to 8 kg (17 lbs.)	053.3332.071
Soft close Hawa Clipo 16/Hawa Regal C 16, up to 16 kg (35 lbs.)	053.3332.072

Set consisting of:

		053.3332.071	053.3332.072	No.
	Damper, up to 8 kg (17 lbs.)	2		053.3330.071
	Trigger, with stopper	2	2	053.3331.071
	Cross recessed pan head screw, 2.2x8 mm (3/32"x5/16"), steel, zinc-plated	2	2	600.0000.482
	Damper, up to 16 kg (35 lbs.)		2	053.3330.072




Handle profiles

		mm (inch)	No.
	Handle profile, groove for brush seal, for screw fixing, aluminum, anodized, pre-drilled	2,500 (8' 2 7/16")	055.3140.250
		6,000 (19' 8 7/32")	055.3140.600

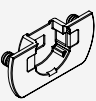

Door centering

	No.
Door centering, plastic, anthracite, for 2 doors	053.3207.071

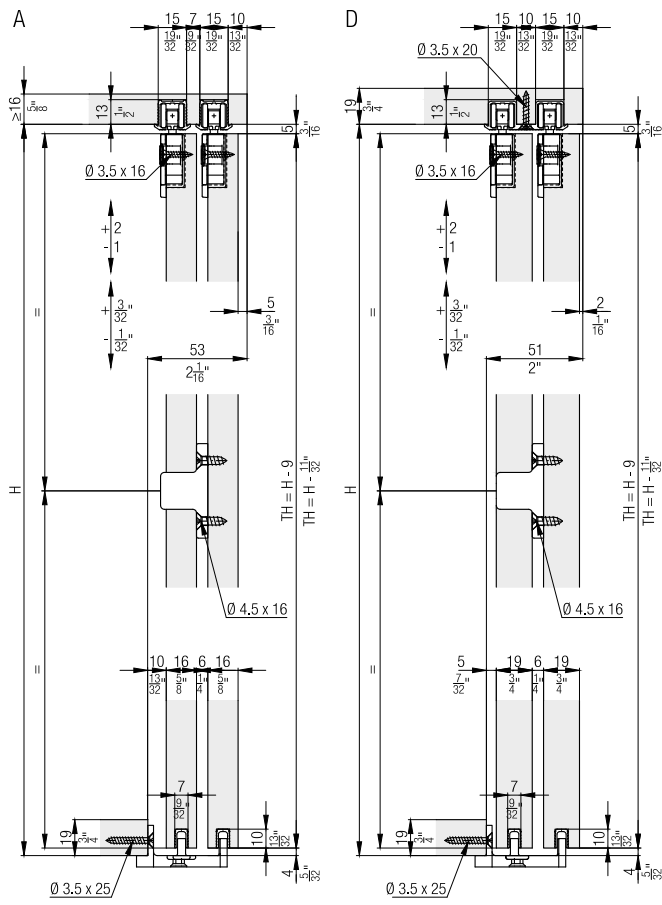
Set consisting of:

		053.3207.071	No.
	Housing door centering, plastic, anthracite	2	053.5014.001
	Pin door centering, plastic, anthracite	2	053.0171.001
	Rubber buffer, plastic, grey	1	025.0107.001

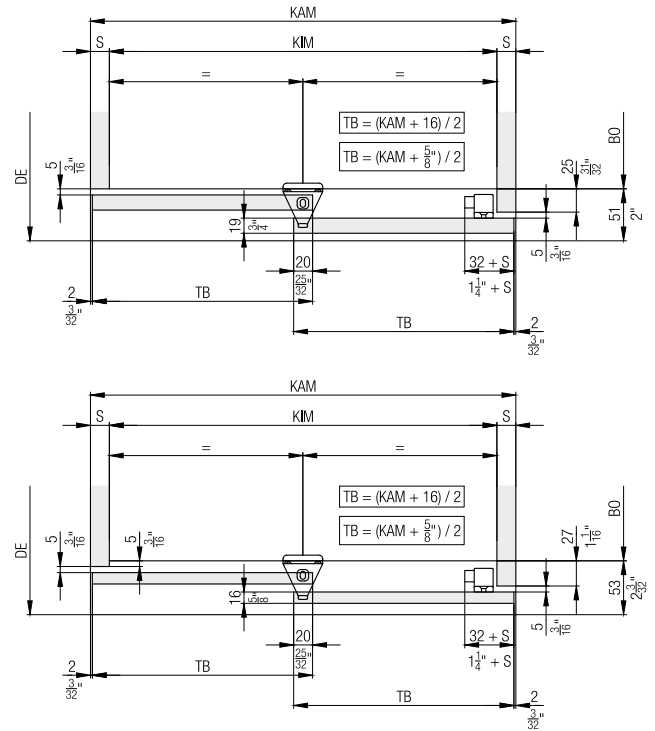
Accessories

		No.
	Housing Hawa Clipo 16, press-fit, plastic, anthracite	083.3009.002
	Track cleaner, plastic, red	040.3142.071

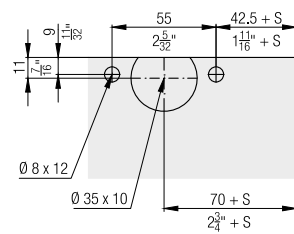
Further installation examples



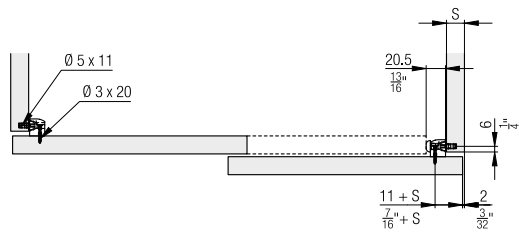
Calculations



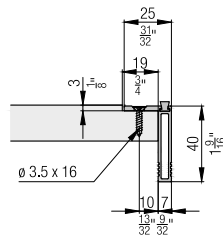
Housing for press-fitting



Door centering



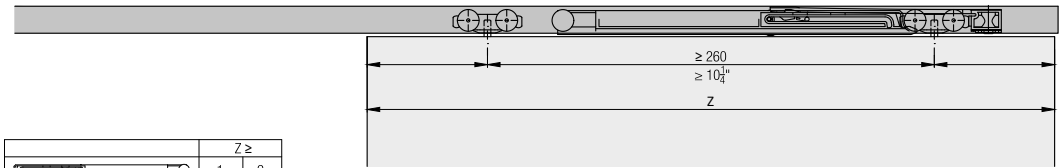
Handle profiles



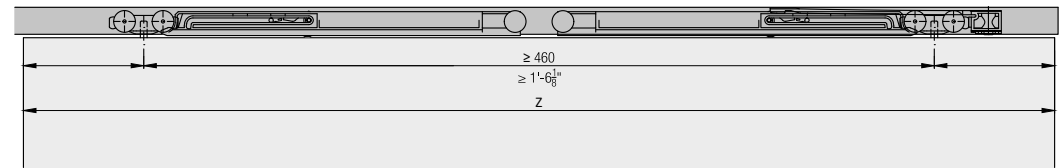
Soft close



	Z ≥	
	1	2
Hawa Clipo 16 H IS	1' 3 ³ / ₄ "	1' 11 ⁵ / ₈ "
Hawa Clipo 16 H MS	1' 5 ¹ / ₄ "	2' 1 ⁵ / ₈ "
Hawa Clipo 16 H FS	1' 5 ¹ / ₄ "	2' 1 ⁵ / ₈ "
Hawa Clipo 16 HM IS	1' 3 ³ / ₄ "	1' 11 ⁵ / ₈ "
Hawa Clipo 16 GK IS	1' 3 ³ / ₄ "	1' 11 ⁵ / ₈ "
Hawa Clipo 16 GS IS	1' 3 ³ / ₄ "	1' 11 ⁵ / ₈ "
Hawa Clipo 16 GPK IS	1' 3 ³ / ₄ "	1' 11 ⁵ / ₈ "
Hawa Clipo 16 GPPK IS	1' 3 ³ / ₄ "	1' 11 ⁵ / ₈ "



	Z ≥	
	1	2
Hawa Clipo 16 H IS	400	600
Hawa Clipo 16 H MS	438	638
Hawa Clipo 16 H FS	438	638
Hawa Clipo 16 HM IS	400	600
Hawa Clipo 16 GK IS	400	600
Hawa Clipo 16 GS IS	400	600
Hawa Clipo 16 GPK IS	400	600
Hawa Clipo 16 GPPK IS	400	600



Accessories

– Straightening fitting from page 236






Planning/execution

Further information about the product can be found on www.hawa.com.

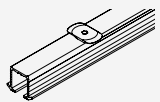
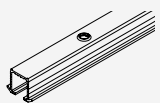
Set for 1 wooden door up to 16 kg (35 lbs.), with height adjustment

	No.
Hawa Clipo 16 H FS, 3-point guide, for 1 door	053.3298.071

Set consisting of:

		053.3298.071	No.
	Running gear, outer door	2	053.3290.172
	Hawa Clipo 16/Hawa Regal 16 C stopper, plastic, gray	2	053.3215.071
	Running gear angle, steel, zinc-plated	2	053.3291.171
	Flat countersunk head chipboard screw, 4.5x16 mm (3/16"x5/8"), steel, zinc-plated	10	600.0000.478
	Bottom guide, plastic	1	053.3292.001



Running tracks

		mm (inch)	No.
	A: Single running track, for glue fixing, aluminum	2,500 (8' 2 7/16")	053.3229.250
		3,500 (11' 5 25/32")	053.3229.350
		6,000 (19' 8 7/32")	053.3229.600
	B: Single running track, with swivel-lug, aluminum (not for hard wood/MDF)	2,500 (8' 2 7/16")	053.3227.250
		3,500 (11' 5 25/32")	053.3227.350
		6,000 (19' 8 7/32")	053.3227.600
	C: Single running track, aluminum, pre-drilled	2,500 (8' 2 7/16")	053.3225.250
		3,500 (11' 5 25/32")	053.3225.350
		6,000 (19' 8 7/32")	053.3225.600

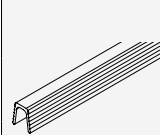
Track end piece set for single running tracks

	No.
Track end piece, for screw fixing, plastic, gray	053.3210.081
Track end piece, with swivel lug, plastic, gray	053.3211.081

Set consisting of:

		053.3210.081	053.3211.081	No.
	Track-end piece, for screw fixing, plastic, grey	2		053.3210.001
	Track-end piece, with swivel lug, plastic, grey		2	053.3211.071

Guide tracks

		mm (inch)	No.
	Guide track, groove width 7 mm (9/32"), plastic, anthracite	2,500 (8' 2 7/16")	053.3012.250
		3,500 (11' 5 25/32")	053.3012.350
		6,000 (19' 8 7/32")	053.3012.600

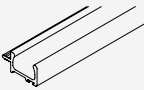

Soft close up to 8/16 kg (17/35 lbs.)

	No.
Soft close Hawa Clipo 16/Hawa Regal C 16, up to 8 kg (17 lbs.)	053.3332.071
Soft close Hawa Clipo 16/Hawa Regal C 16, up to 16 kg (35 lbs.)	053.3332.072


Set consisting of:

		053.3332.071	053.3332.072	No.
	Damper, up to 8 kg (17 lbs.)	2		053.3330.071
	Trigger, with stopper	2	2	053.3331.071
	Cross recessed pan head screw, 2.2x8 mm (3/32"x5/16"), steel, zinc-plated	2	2	600.0000.482
	Damper, up to 16 kg (35 lbs.)		2	053.3330.072

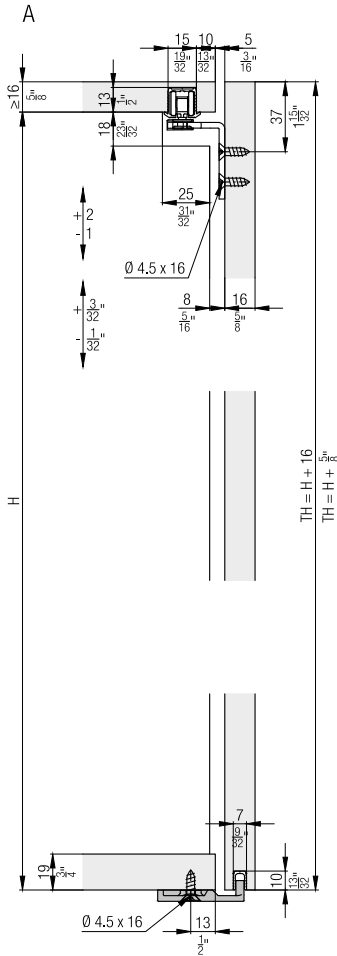
Handle profiles

		mm (inch)	No.
	Handle profile, groove for brush seal, for groove mounting, aluminum, anodized, for door thickness of 19 mm (3/4")	2,500 (8' 2 7/16")	056.3028.250
		6,000 (19' 8 7/32")	056.3028.600
	Handle profile, groove for brush seal, for screw fixing, aluminum, anodized, pre-drilled	2,500 (8' 2 7/16")	055.3140.250
		6,000 (19' 8 7/32")	055.3140.600

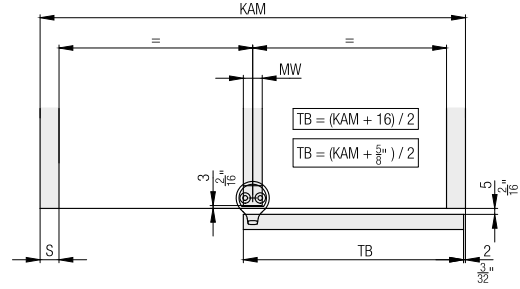
Accessories

		No.
	Track cleaner, plastic, red	040.3142.071

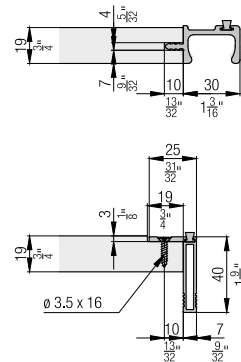
Further installation examples



Calculations



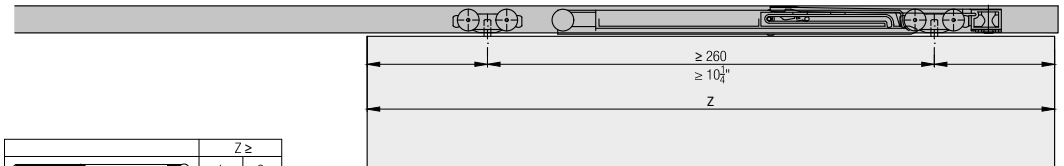
Handle profiles



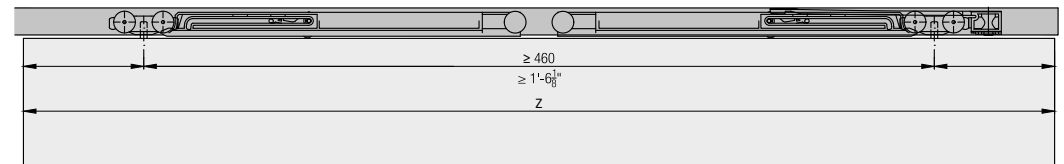
Soft close



	Z ≥	
	1	2
Hawa Clipo 16 H IS	1' 3 3/4"	1' 1 1/8"
Hawa Clipo 16 H MS	1' 5 1/4"	2' 1 1/8"
Hawa Clipo 16 H FS	1' 5 1/4"	2' 1 1/8"
Hawa Clipo 16 HM IS	1' 3 3/4"	1' 1 1/8"
Hawa Clipo 16 GK IS	1' 3 3/4"	1' 1 1/8"
Hawa Clipo 16 GS IS	1' 3 3/4"	1' 1 1/8"
Hawa Clipo 16 GPK IS	1' 3 3/4"	1' 1 1/8"
Hawa Clipo 16 GPPK IS	1' 3 3/4"	1' 1 1/8"



	Z ≥	
	1	2
Hawa Clipo 16 H IS	400	600
Hawa Clipo 16 H MS	438	638
Hawa Clipo 16 H FS	438	638
Hawa Clipo 16 HM IS	400	600
Hawa Clipo 16 GK IS	400	600
Hawa Clipo 16 GS IS	400	600
Hawa Clipo 16 GPK IS	400	600
Hawa Clipo 16 GPPK IS	400	600



Accessories

– Straightening fitting from page 236

Planning/execution

Further information about the product can be found on www.hawa.com.

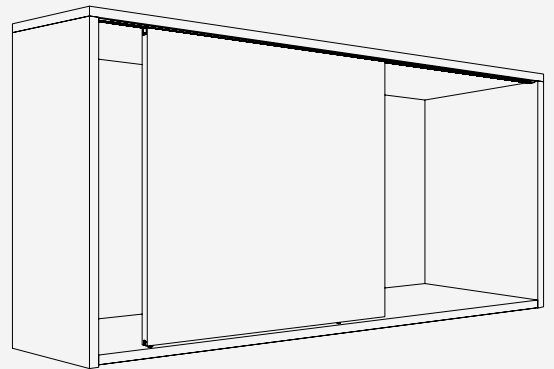
Fitting for 1-2 top-running wooden doors up to 16 kg (35 lbs.), with groove mounted running track. With soft and self closing mechanism. Design Inside.

Product highlights

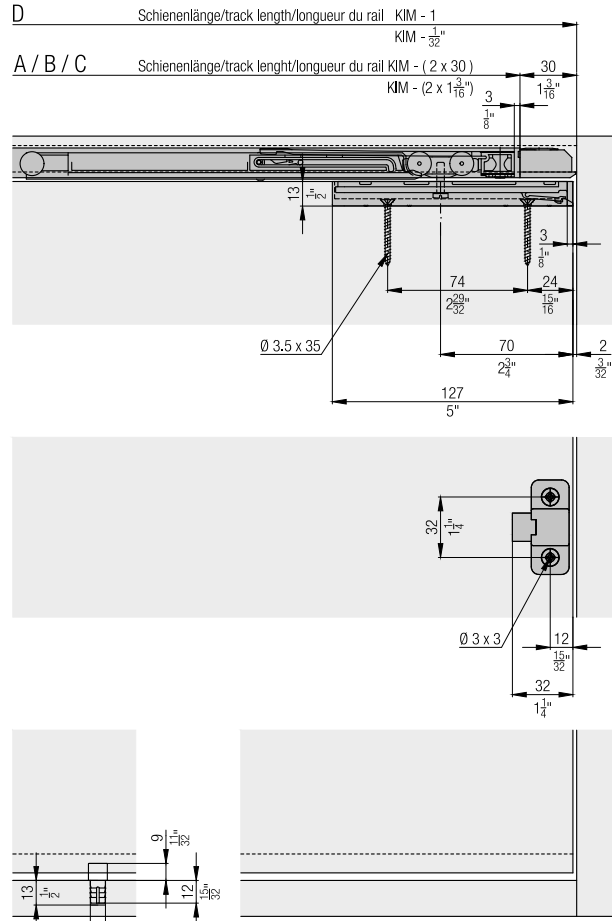
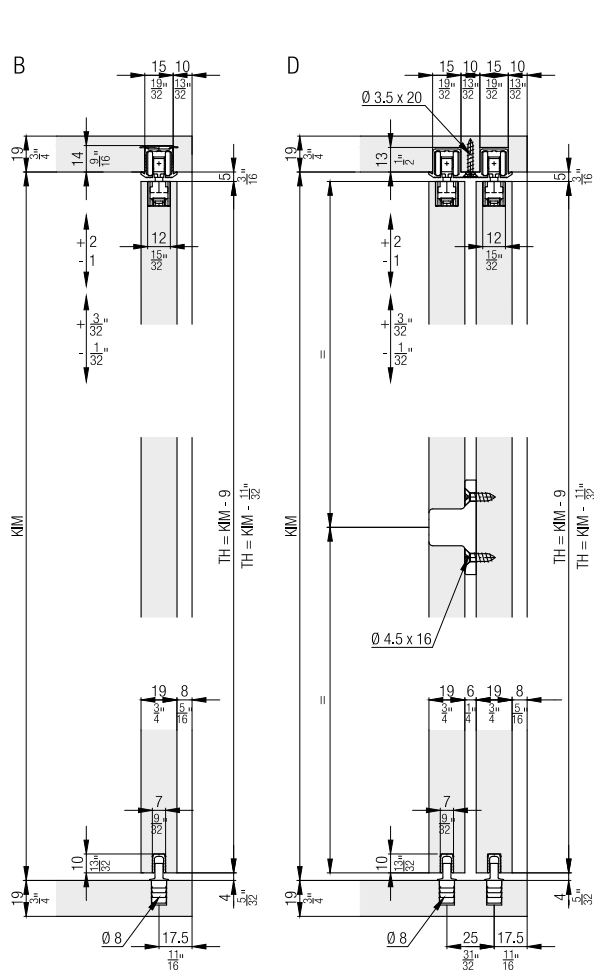
- Aesthetics** Optimum solution for serving hatches thanks to the lateral, concealed running system
- Comfort** Smooth, silent running with Comfort Roller and soft and self closing system for different door weights

Technical specifications

- Max. 16 kg (35 lbs.)
- Max. 1400 mm (4'7 1/8")
- Max. 1000 mm (3'3 3/8")
- 19-25 mm (3/4" to 31/32")



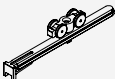




Installation examples



Set for 1 wooden door up to 16 kg (35 lbs.),
with height adjustment
Always order 2 sets with 2 doors.

	No.
Hawa Clipo 16 HM IS, for 1 door	053.3223.071



Set consisting of:

		053.3223.071	No.
	Running gear Hawa Clipo 16, with support and screw	2	053.3224.071
	Hawa Clipo 16/ Hawa Regal 16 C stopper, plastic, gray	2	053.3215.071
	Housing, plastic, anthracite	2	053.0216.001
	Flat countersunk head chipboard screw 3,5x35 mm (5/32"x1 3/8"), steel, zinc-plated	4	766.5035.135
	Hawa Clipo 16 H bottom guide, plastic, anthracite	1	053.3214.001

Door follower
Order 1 set with 2 doors.

	No.
Set door follower	053.3236.171

Set consisting of:

		053.3236.171	No.
	Door follower, plastic, anthracite	1	053.3217.071
	Flat countersunk head chipboard screw, 4.5x16 mm (3/16"x5/8"), steel, zinc-plated	2	600.0000.478



Running tracks

		mm (inch)	No.
	A: Single running track, for glue fixing, aluminum	2,500 (8' 2 7/16")	053.3229.250
		3,500 (11' 5 25/32")	053.3229.350
		6,000 (19' 8 7/32")	053.3229.600
	B: Single running track, with swivel-lug, aluminum (pas pour bois dur/MDF)	2,500 (8' 2 7/16")	053.3227.250
		3,500 (11' 5 25/32")	053.3227.350
		6,000 (19' 8 7/32")	053.3227.600
	C: Single running track, aluminum, pre-drilled	2,500 (8' 2 7/16")	053.3225.250
		3,500 (11' 5 25/32")	053.3225.350
		6,000 (19' 8 7/32")	053.3225.600
	D: Double running track, aluminum, pre-drilled	2,500 (8' 2 7/16")	053.3226.250
		3,500 (11' 5 25/32")	053.3226.350
		6,000 (19' 8 7/32")	053.3226.600

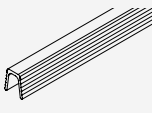
Track end piece set for single running tracks

	No.
Track end piece, for screw fixing, plastic, gray	053.3210.081
Track end piece, with swivel lug, plastic, gray	053.3211.081

Set consisting of:

		053.3210.081	053.3211.081	No.
	Track-end piece, for screw fixing, plastic, grey	2		053.3210.001
	Track-end piece, with swivel lug, plastic, grey		2	053.3211.071

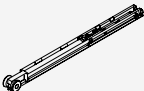
Guide tracks

		mm (inch)	No.
	Guide track, groove width 7 mm (9/32"), plastic, anthracite	2,500 (8' 2 7/16")	053.3012.250
		3,500 (11' 5 25/32")	053.3012.350
		6,000 (19' 8 7/32")	053.3012.600

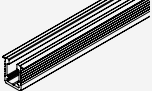
Soft close up to 8/16 kg (17/35 lbs.)

	No.
Soft close Hawa Clipo 16/Hawa Regal C 16, up to 8 kg (17 lbs.)	053.3332.071
Soft close Hawa Clipo 16/Hawa Regal C 16, up to 16 kg (35 lbs.)	053.3332.072



Set consisting of:

		053.3332.071	053.3332.072	No.
	Damper, up to 8 kg (17 lbs.)	2		053.3330.071
	Trigger, with stopper	2	2	053.3331.071
	Cross recessed pan head screw, 2.2x8 mm (3/32"x5/16"), steel, zinc-plated	2	2	600.0000.482
	Damper, up to 16 kg (35 lbs.)		2	053.3330.072


Guide tracks 4-point guidance

		mm (inch)	No.
	Single guide track, for glue fixing, aluminum, anodized	6,000 (19' 8 7/32")	053.3296.600

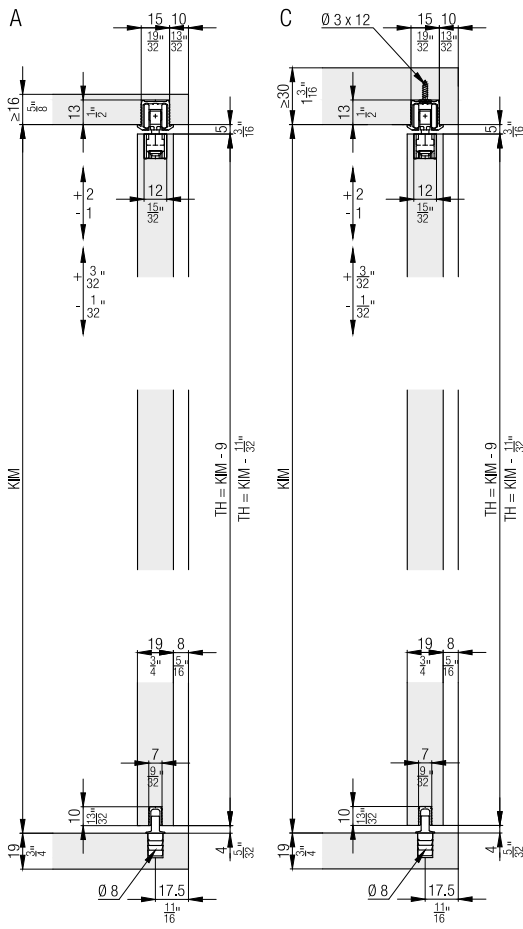
Components 4-point guidance

		No.
	Bottom guide Hawa Clipo IS/ Hawa Regal C 16, plastic, anthracite	040.3124.071
	Stopper guide track, plastic, grey	053.5094.071

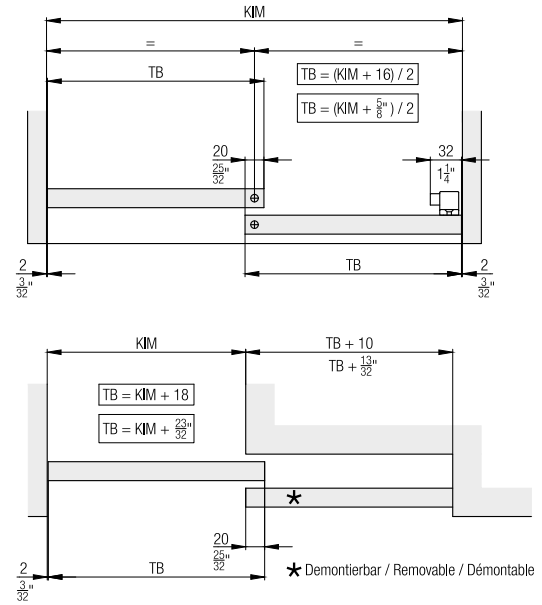
Accessories

		No.
	Track cleaner, plastic, red	040.3142.071

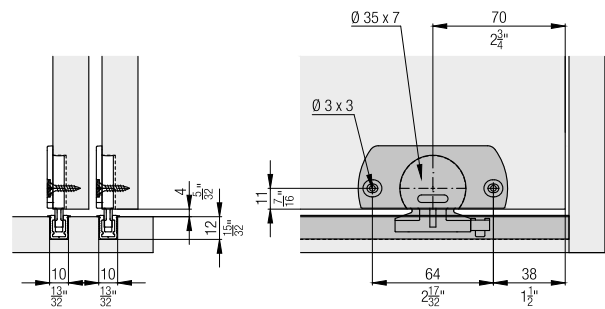
Further installation examples



Calculations



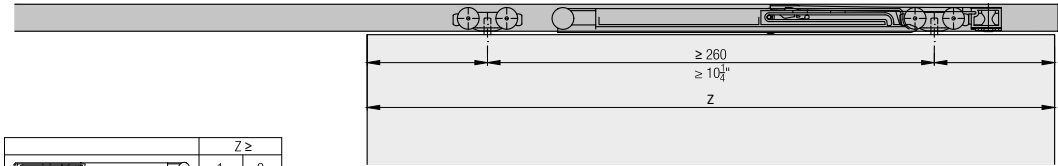
4 point guidance



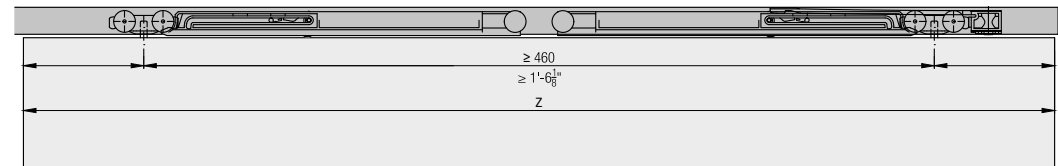
Soft close



	Z ≥	
	1	2
Hawa Clipo 16 H IS	1' 3 ³ / ₄ "	1' 11 ⁵ / ₈ "
Hawa Clipo 16 H MS	1' 5 ¹ / ₄ "	2' 1 ⁵ / ₈ "
Hawa Clipo 16 H FS	1' 5 ¹ / ₄ "	2' 1 ⁵ / ₈ "
Hawa Clipo 16 HM IS	1' 3 ³ / ₄ "	1' 11 ⁵ / ₈ "
Hawa Clipo 16 GK IS	1' 3 ³ / ₄ "	1' 11 ⁵ / ₈ "
Hawa Clipo 16 GS IS	1' 3 ³ / ₄ "	1' 11 ⁵ / ₈ "
Hawa Clipo 16 GPK IS	1' 3 ³ / ₄ "	1' 11 ⁵ / ₈ "
Hawa Clipo 16 GPPK IS	1' 3 ³ / ₄ "	1' 11 ⁵ / ₈ "



	Z ≥	
	1	2
Hawa Clipo 16 H IS	400	600
Hawa Clipo 16 H MS	438	638
Hawa Clipo 16 H FS	438	638
Hawa Clipo 16 HM IS	400	600
Hawa Clipo 16 GK IS	400	600
Hawa Clipo 16 GS IS	400	600
Hawa Clipo 16 GPK IS	400	600
Hawa Clipo 16 GPPK IS	400	600



Accessories



– Straightening fitting from page 236

Planning/execution





Further information about the product can be found on www.hawa.com.

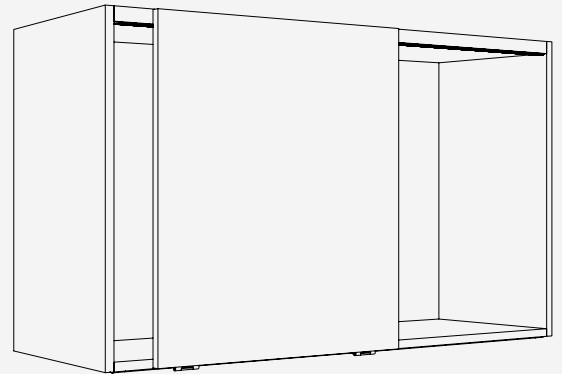
Fitting for 1 top-running wooden door up to 16 kg (35 lbs.), with groove mounted running track. With soft and self closing mechanism. Design Forslide.

Product highlights

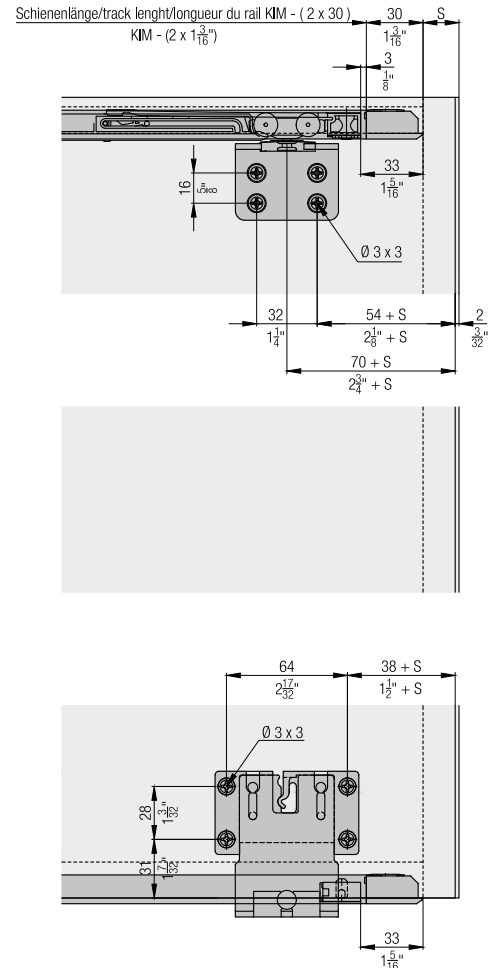
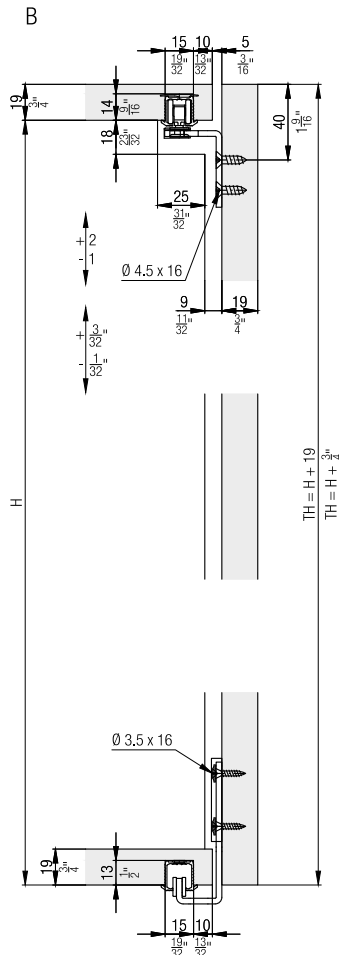
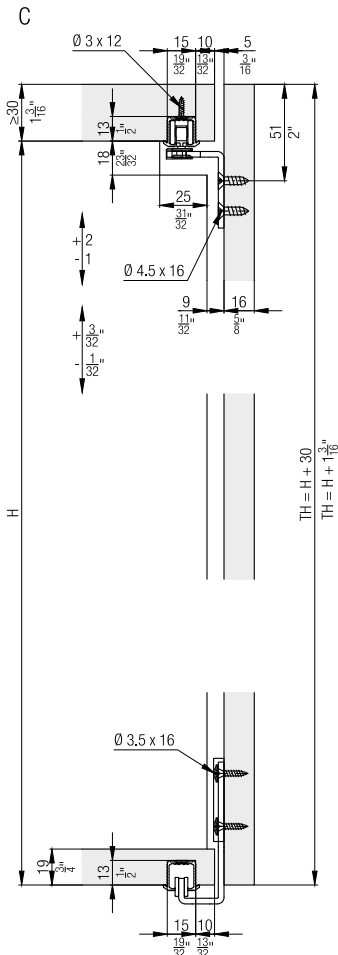
-  **Security** 4 point guidance for high functional reliability
-  **Productivity** Efficient thanks to tool-less door installation as well as easy, intuitive adjustment

Technical specifications

-  Max. 16 kg (35 lbs.)
-  Max. 1400 mm (4'7 1/8")
-  Max. 1000 mm (3'3 3/8")
-  16–25 mm (5/8" to 31/32")



Installation examples



Set for 1 wooden door up to 16 kg (35 lbs.), with height adjustment

	No.
Hawa Clipo 16 H FS, 4-point guide, for 1 door	053.3299.071

Set consisting of:



		053.3299.071	No.
	Running gear, outer door	2	053.3290.172
	Hawa Clipo 16/Hawa Regal 16 C stopper, plastic, gray	2	053.3215.071
	Running gear angle, steel, zinc-plated	2	053.3291.171
	Flat countersunk head chipboard screw, 4.5x16 mm (3/16"x5/8"), steel, zinc-plated	8	600.0000.478
	Guide angle, steel, zinc-plated	2	053.3293.171
	Guide bracket housing, plastic, anthracite	2	053.3064.001
	Fillister head screw, 3.5x16 mm (5/32"x5/8"), steel, zinc-plated	8	766.6052.100
	Stopper with retention Hawa Regal C 16, plastic, grey	2	040.3122.071

Running tracks

		mm (inch)	No.
	A: Single running track, for glue fixing, aluminum	2,500 (8' 2 7/16")	053.3229.250
		3,500 (11' 5 25/32")	053.3229.350
		6,000 (19' 8 7/32")	053.3229.600
	B: Single running track, with swivel-lug, aluminum (not for hard wood/MDF)	2,500 (8' 2 7/16")	053.3227.250
		3,500 (11' 5 25/32")	053.3227.350
		6,000 (19' 8 7/32")	053.3227.600
	C: Single running track, aluminum, pre-drilled	2,500 (8' 2 7/16")	053.3225.250
		3,500 (11' 5 25/32")	053.3225.350
		6,000 (19' 8 7/32")	053.3225.600

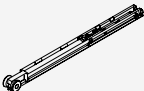

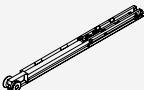
Track end piece set for single running tracks

	No.
Track end piece, for screw fixing, plastic, grey	053.3210.081
Track end piece, with swivel lug, plastic, grey	053.3211.081

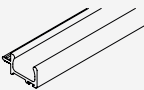

		053.3210.081	053.3211.081	No.
Set consisting of:				
	Track-end piece, for screw fixing, plastic, grey	2		053.3210.001
	Track-end piece, with swivel lug, plastic, grey	2		053.3211.071

Soft close up to 8/16 kg (17/35 lbs.)


	No.
Soft close Hawa Clipo 16/Hawa Regal C 16, up to 8 kg (17 lbs.)	053.3332.071
Soft close Hawa Clipo 16/Hawa Regal C 16, up to 16 kg (35 lbs.)	053.3332.072

		053.3332.071	053.3332.072	No.
Set consisting of:				
	Damper, up to 8 kg (17 lbs.)	2		053.3330.071
	Trigger, with stopper	2	2	053.3331.071
	Cross recessed pan head screw, 2.2x8 mm (3/32"x5/16"), steel, zinc-plated	2	2	600.0000.482
	Damper, up to 16 kg (35 lbs.)		2	053.3330.072

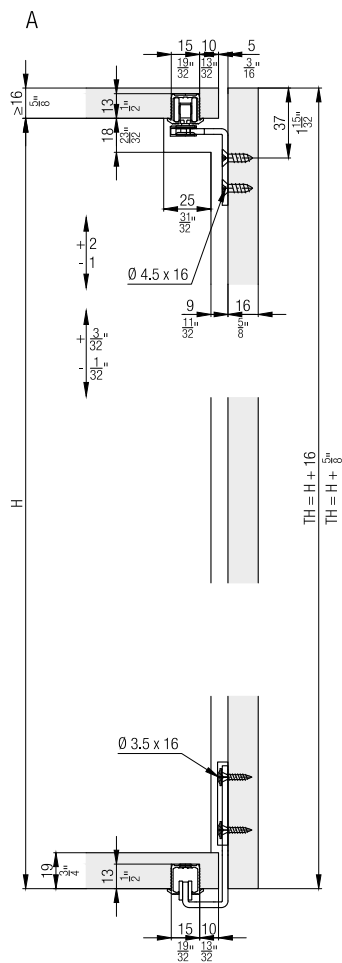
Handle profiles

		mm (inch)	No.
	Handle profile, groove for brush seal, for groove mounting, aluminum, anodized, for door thickness of 19 mm (3/4")	2,500 (8' 2 7/16")	056.3028.250
		6,000 (19' 8 7/32")	056.3028.600
	Handle profile, groove for brush seal, for screw fixing, aluminum, anodized, pre-drilled	2,500 (8' 2 7/16")	055.3140.250
		6,000 (19' 8 7/32")	055.3140.600

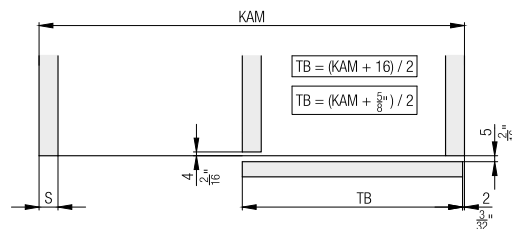
Accessories

	No.
	Track cleaner, plastic, red 040.3142.071

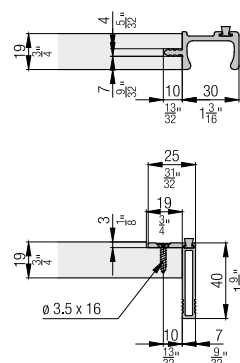
Further installation examples



Calculations

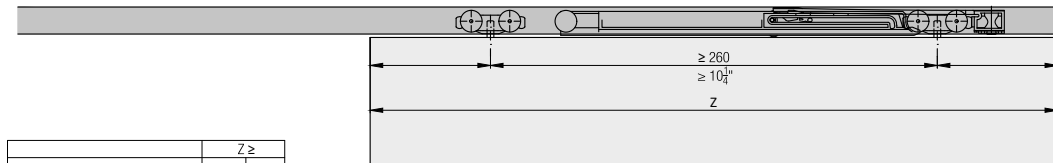


Handle profiles

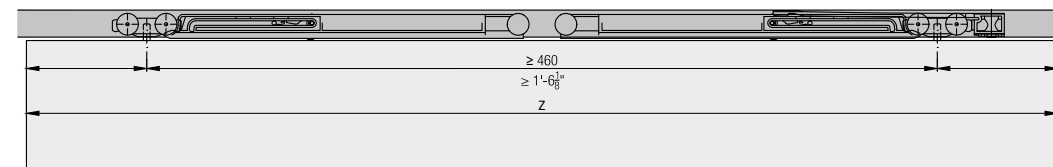
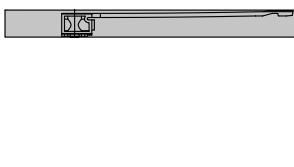


Soft close

	Z ≥	
	1	2
Hawa Clipo 16 H IS	1' 33 32"	1' 11 8"
Hawa Clipo 16 H MS	1' 5 4"	2' 1 8"
Hawa Clipo 16 H FS	1' 5 4"	2' 1 8"
Hawa Clipo 16 HM IS	1' 3 32"	1' 11 8"
Hawa Clipo 16 GK IS	1' 3 32"	1' 11 8"
Hawa Clipo 16 GS IS	1' 3 32"	1' 11 8"
Hawa Clipo 16 GPK IS	1' 3 32"	1' 11 8"
Hawa Clipo 16 GPPK IS	1' 3 32"	1' 11 8"



	Z ≥	
	1	2
Hawa Clipo 16 H IS	400	600
Hawa Clipo 16 H MS	438	638
Hawa Clipo 16 H FS	438	638
Hawa Clipo 16 HM IS	400	600
Hawa Clipo 16 GK IS	400	600
Hawa Clipo 16 GS IS	400	600
Hawa Clipo 16 GPK IS	400	600
Hawa Clipo 16 GPPK IS	400	600



Accessories



– Straightening fitting from page 236

Planning/execution


Further information about the product can be found on www.hawa.com.

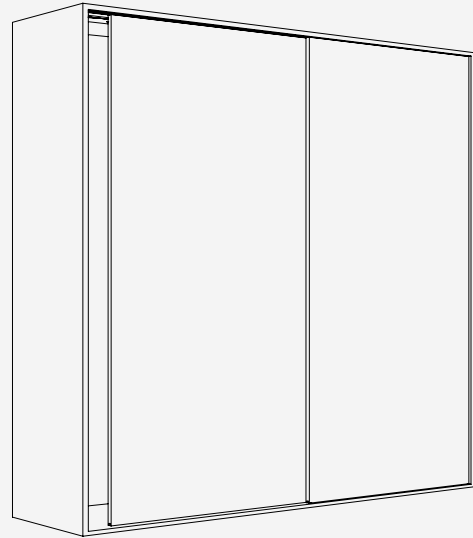
Fitting for 2 top-running wooden doors up to 26 kg (57 lbs.), with groove mounted running track. With soft and self closing mechanism. Design Inside.

Product highlights

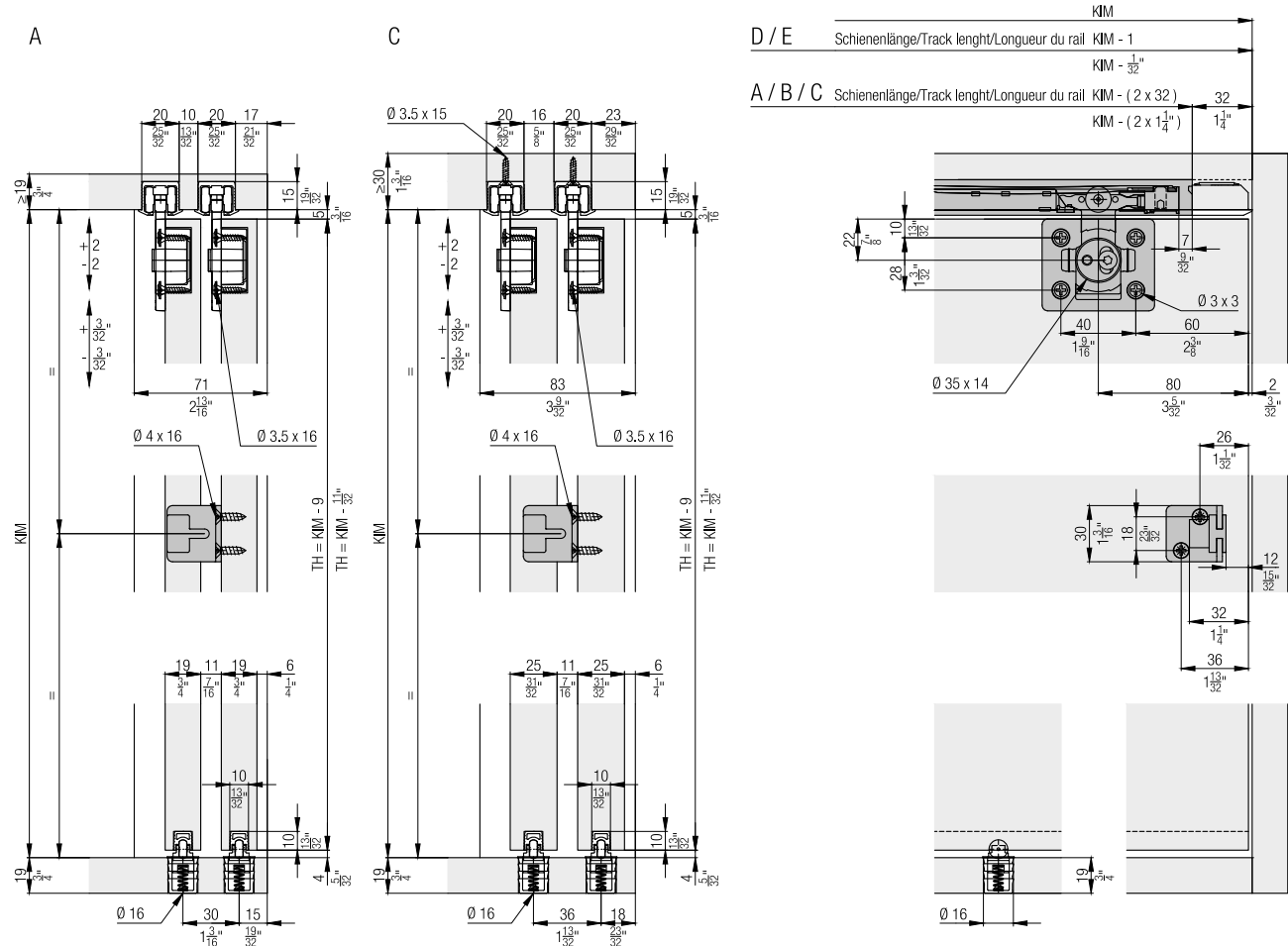
-  **Flexibility** Wide range of applications for sliding door cabinets in any dimension
-  **Productivity** Easy installation with tool-less clip-on system and convenient height adjustment

Technical specifications

-  Max. 26 kg (57 lbs.)
-  Max. 2200 mm (7'2 5/8")
-  Max. 1000 mm (3'3 3/8")
-  19–25 mm (3/4" to 31/32")



Installation examples



**Set for 2 wooden doors up to 26 kg (57 lbs.),
with height adjustment**

	No.
Hawa Clipo 26 H IS, for 2 doors	053.3353.071

Set consisting of:

		053.3353.071	No.
	Running gear, left	2	053.3349.071
	Running gear, right	2	053.3348.071
	Stopper, plastic, gray	4	057.3148.071
	Housing, plastic	4	053.0332.001
	Fillister head screw, 3.5x16 mm (5/32"x5/8"), steel, zinc-plated	16	766.6052.100
	Follower Hawa Combino/ Hawa Clipo, plastic	1	055.3123.071
	Adapter to follower steel, zinc-plated	1	055.0213.101
	Flat countersunk head chipboard screw 4x16 mm (5/32"x5/8"), steel, zinc-plated	2	600.0000.253
	Bottom guide, plastic, gray	2	055.3081.071




Running tracks

		mm (inch)	No.
	A: Single running track, for glue fixing, aluminum, anodized	2,500 (8' 2 7/16")	053.3324.250
		3,500 (11' 5 25/32")	053.3324.350
		6,000 (19' 8 7/32")	053.3324.600
	B: Single running track, swivel lug, aluminum, anodized (not for hard wood/MDF)	2,500 (8' 2 7/16")	053.3327.250
		3,500 (11' 5 25/32")	053.3327.350
		6,000 (19' 8 7/32")	053.3327.600
	C: Single running track, for screw fixing, aluminum, anodized	2,500 (8' 2 7/16")	053.3325.250
		3,500 (11' 5 25/32")	053.3325.350
		6,000 (19' 8 7/32")	053.3325.600
	D: Double running track, for screw fixing, aluminum, anodized, for door thickness of 25 mm (31/32")	2,500 (8' 2 7/16")	053.3328.250
		3,500 (11' 5 25/32")	053.3328.350
		6,000 (19' 8 7/32")	053.3328.600
	E: Double running track, for screw fixing, aluminum, anodized, for door thickness of 19 mm (3/4")	2,500 (8' 2 7/16")	053.3339.250
		3,500 (11' 5 25/32")	053.3339.350
		6,000 (19' 8 7/32")	053.3339.600

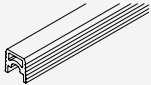
Track end piece set for single running tracks

	No.
Track-end section, for screw fixing, plastic, gray, 2-piece set	053.3354.071
Track-end section, swivel lug, plastic, gray, 2-piece set	053.3355.051


Set consisting of:

	053.3354.071	053.3355.051	No.
 Track-end piece, for screw fixing, plastic	2		053.0334.001
 Chipboard screw, 4x12 mm (5/32"x15/32"), steel, zinc-plated	2		600.0000.704
 Track-end piece, with swivel lug, plastic		2	053.3351.071

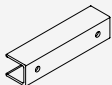
Guide tracks

	mm (inch)	No.
	2,500 (8' 2 7/16")	055.3171.250
	3,500 (11' 5 25/32")	055.3171.350
	6,000 (19' 8 7/32")	055.3171.600

Panels

	mm (inch)	No.
	2,500 (8' 2 7/16")	053.5050.250
	3,500 (11' 5 25/32")	053.5050.350
	6,000 (19' 8 7/32")	053.5050.600

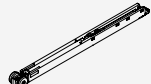


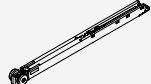
Clip-on components

	No.
 Clip component for wooden panel, for 053.3339, every 700–800 mm (2' 3 9/16" to 2' 7 15/32"), aluminum, pre-drilled	053.5051.001

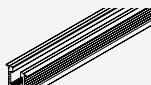
Soft close up to 15/26 kg (33/57 lbs.)

	No.
Soft close, up to 15 kg (33 lbs.)	057.3159.071
Soft close, up to 26 kg (57 lbs.)	057.3159.072



Set consisting of:

	057.3159.071	057.3159.072	No.
 Soft close, up to 15 kg (33 lbs.)	2		057.3156.071
 Release piece soft close	2	2	057.0182.101
 Thread rolling rounded head screw, M2.5x5 mm (3/32"x3/16"), steel, zinc-plated	2	2	600.0000.764
 Soft close, up to 26 kg (57 lbs.)		2	057.3156.072

Guide tracks 4-point guidance




	mm (inch)	No.
 Single guide track, for glue fixing, aluminum, anodized	6,000 (19' 8 7/32")	053.3296.600

Components 4-point guidance


	No.
 Bottom guide Hawa Clipo IS/Hawa Regal C 16, plastic, anthracite	040.3124.071
 Stopper guide track, plastic, grey	053.5094.071

Door centering

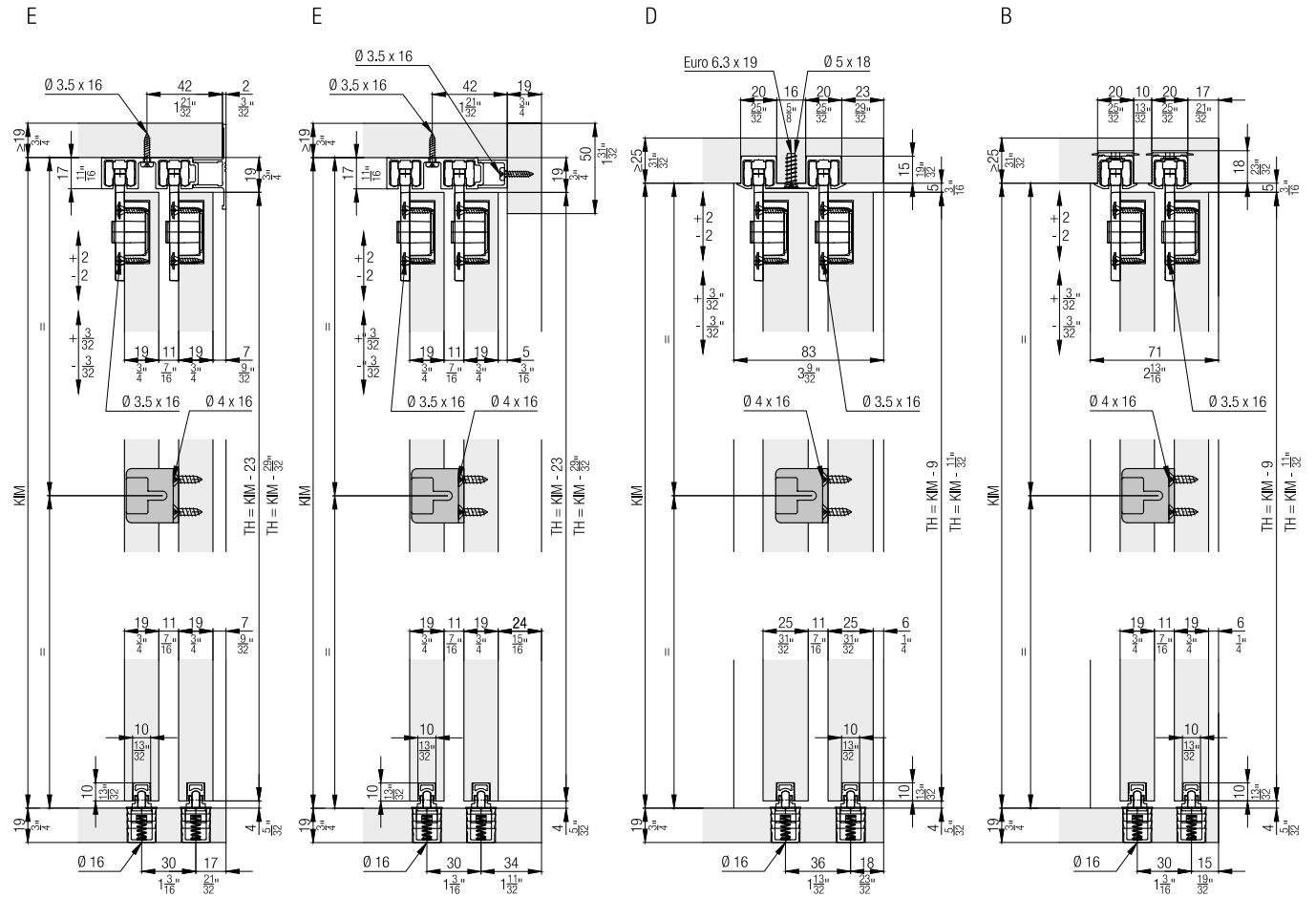
	No.
Door centering, plastic, anthracite, for 2 doors	053.3207.071

		053.3207.071	No.
Set consisting of:			
	Housing door centering, plastic, anthracite	2	053.5014.001
	Pin door centering, plastic, anthracite	2	053.0171.001
	Rubber buffer, plastic, grey	1	025.0107.001

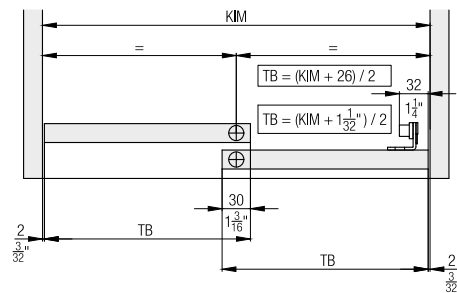
Accessories

	No.	
	Track cleaner, plastic, red	040.3142.071

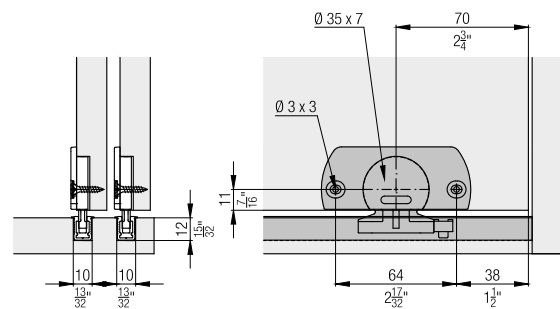
Further installation examples



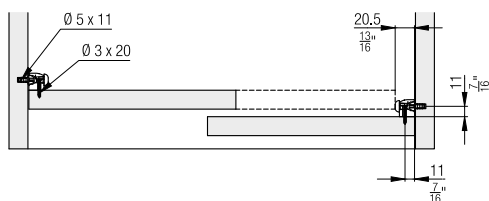
Calculations



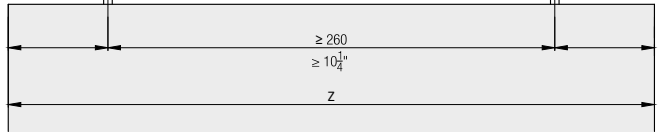
4 point guidance



Door centering

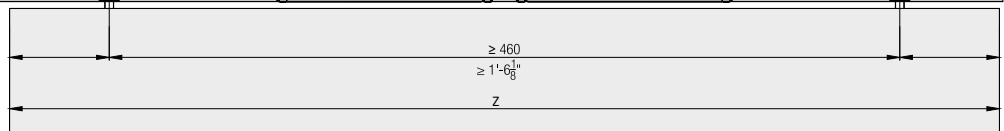


Soft close



	Z ≥	
	1	2
Hawa Porta 40 H	1' 4 17/32"	2' 0 13/32"
Hawa Porta 40 GE	1' 2 13/16"	1' 10 11/16"
Hawa Clipo 26 H IS	1' 4 17/32"	2' 0 13/32"
Hawa Clipo 26 H MS	1' 6 1/32"	2' 1 29/32"
Hawa Clipo 36 H IS	1' 4 17/32"	2' 0 13/32"
Hawa Clipo 36 H MS	1' 6 31/32"	2' 1 29/32"
Hawa Clipo 36 HM IS	1' 4 17/32"	2' 0 13/32"
Hawa Clipo 26 GR IS	1' 4 17/32"	2' 0 13/32"
Hawa Clipo 36 G IS	1' 4 17/32"	2' 0 13/32"
Hawa Clipo 36 GPK IS	1' 4 17/32"	2' 0 13/32"
Hawa Clipo 36 GPPK IS	1' 4 17/32"	2' 0 13/32"
Hawa Regal C 26 HM IS	1' 4 17/32"	2' 0 13/32"
Hawa Regal C 26 GR IS	1' 3 3/4"	1' 11 5/8"

	Z ≥	
	1	2
Hawa Porta 40 H	420	620
Hawa Porta 40 GE	376	576
Hawa Clipo 26 H IS	420	620
Hawa Clipo 26 H MS	458	658
Hawa Clipo 36 H IS	420	620
Hawa Clipo 36 H MS	458	658
Hawa Clipo 36 HM IS	420	620
Hawa Clipo 26 GR IS	420	620
Hawa Clipo 36 G IS	420	620
Hawa Clipo 36 GPK IS	420	620
Hawa Clipo 36 GPPK IS	420	620
Hawa Regal C 26 HM IS	420	620
Hawa Regal C 26 GR IS	400	600



Accessories

– Straightening fitting from page 236

Planning/execution

Further information about the product can be found on www.hawa.com.

Fitting for 2-3 top-running wooden doors up to 26 kg (57 lbs.), with groove mounted running track. With soft and self closing mechanism. Design Mixslide.

Product highlights



Comfort Quiet, smooth running and soft and self closing system for different door weights



Productivity Easy installation with tool-less clip-on system and convenient height adjustment

Technical specifications



Max. 26 kg (57 lbs.)



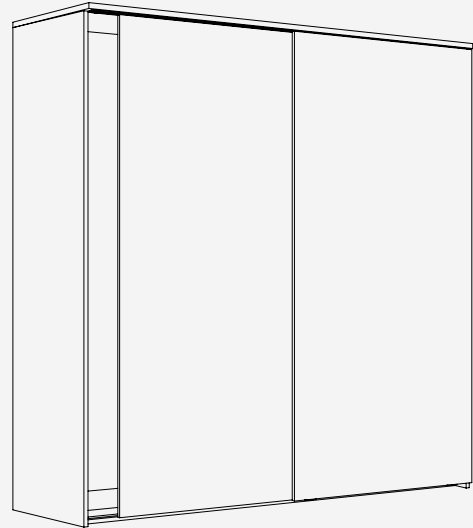
Max. 2200 mm (7'2 5/8")



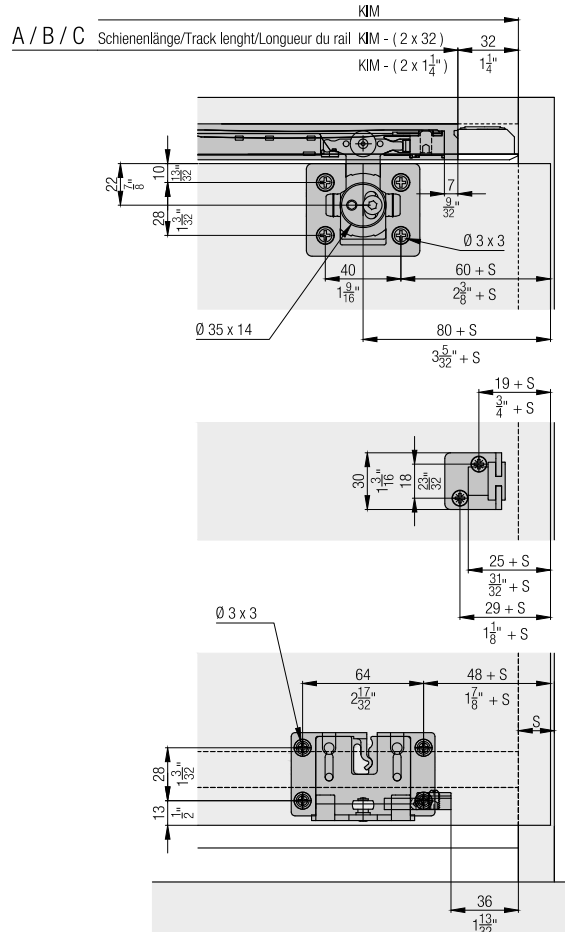
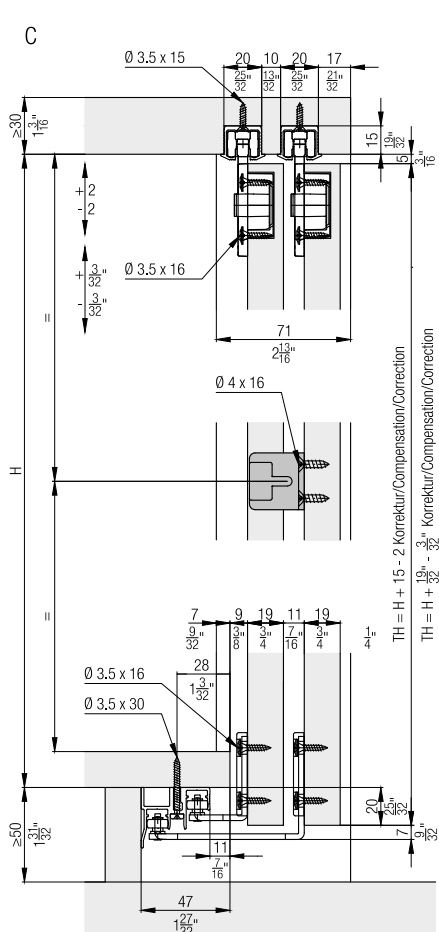
Max. 1000 mm (3'3 3/8")



19 mm (3/4")




Installation examples










**Set for 2 wooden doors up to 26 kg (57 lbs.),
with height adjustment**

	No.
Hawa Clipo 26 H MS, for 2 doors	053.3356.071

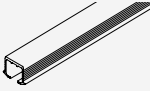
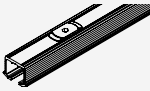
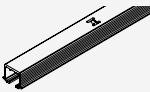
Set consisting of:		053.3356.071	No.
	Running gear, left	2	053.3349.071
	Running gear, right	2	053.3348.071
	Stopper, plastic, gray	4	057.3148.071
	Housing, plastic	4	053.0332.001
	Fillister head screw, 3.5x16 mm (5/32"x5/8"), steel, zinc-plated	32	766.6052.100
	Follower Hawa Combino/Hawa Clipo, plastic	1	055.3123.071
	Adapter to follower steel, zinc-plated	1	055.0213.101
	Flat countersunk head chipboard screw 4x16 mm (5/32"x5/8"), steel, zinc-plated	2	600.0000.253
	Guide bracket, interior door, steel, zinc-plated	2	055.3107.171
	Guide bracket, exterior door, 19 mm (3/4"), steel, zinc-plated	2	055.3109.171
	Guide bracket housing, plastic, anthracite	4	053.3064.001
	Stopper guide, plastic, gray	4	040.3079.074

**Set for 3 wooden doors up to 26 kg (57 lbs.),
with height adjustment**

	No.
Hawa Clipo 26 H MS, for 3 doors	053.3356.072




Set consisting of:		053.3356.072	No.
	Running gear, left	3	053.3349.071
	Running gear, right	3	053.3348.071
	Stopper, plastic, gray	4	057.3148.071
	Housing, plastic	6	053.0332.001
	Fillister head screw, 3.5x16 mm (5/32"x5/8"), steel, zinc-plated	48	766.6052.100
	Buffer, with adhesive	2	061.3083.001
	Guide bracket, interior door, steel, zinc-plated	4	055.3107.171
	Guide bracket, exterior door, 19 mm (3/4"), steel, zinc-plated	2	055.3109.171
	Guide bracket housing, plastic, anthracite	6	053.3064.001
	Door follower, steel, zinc-plated, with 3 doors	2	055.3126.171
	Thread-cutting rounded head screw, M4x8 mm (5/32"x5/16"), steel, zinc-plated	2	600.0000.328
	Stopper guide, plastic, gray	4	040.3079.074

Running tracks

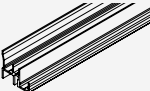
		mm (inch)	No.
	A: Single running track, for glue fixing, aluminum, anodized	2,500 (8' 2 7/16")	053.3324.250
		3,500 (11' 5 25/32")	053.3324.350
		6,000 (19' 8 7/32")	053.3324.600
	B: Single running track, swivel lug, aluminum, anodized (not for hard wood/ MDF)	2,500 (8' 2 7/16")	053.3327.250
		3,500 (11' 5 25/32")	053.3327.350
		6,000 (19' 8 7/32")	053.3327.600
	C: Single running track, for screw fixing, aluminum, anodized	2,500 (8' 2 7/16")	053.3325.250
		3,500 (11' 5 25/32")	053.3325.350
		6,000 (19' 8 7/32")	053.3325.600

Track end piece set for single running tracks

	No.
Track-end section, for screw fixing, plastic, gray, 2-piece set	053.3354.071
Track-end section, swivel lug, plastic, gray, 2-piece set	053.3355.051

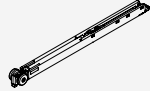


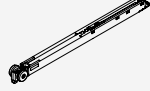
		053.3354.071	053.3355.051	No.
Set consisting of:				
	Track-end piece, for screw fixing, plastic	2		053.0334.001
	Chipboard screw, 4x12 mm (5/32"x15/32"), steel, zinc-plated	2		600.0000.704
	Track-end piece, with swivel lug, plastic		2	053.3351.071

Guide tracks


		mm (inch)	No.
	Double guide track, for screw fixing, aluminum, anodized, pre-drilled	2,500 (8' 2 7/16")	056.3072.250
		3,500 (11' 5 25/32")	056.3072.350
		6,000 (19' 8 7/32")	056.3072.600

Soft close up to 15/26 kg (33/57 lbs.)


	No.
Soft close, up to 15 kg (33 lbs.)	057.3159.071
Soft close, up to 26 kg (57 lbs.)	057.3159.072

		057.3159.071	057.3159.072	No.
Set consisting of:				
	Soft close, up to 15 kg (33 lbs.)	2		057.3156.071
	Release piece soft close	2	2	057.0182.101
	Thread rolling rounded head screw, M2.5x5 mm (3/32"x3/16"), steel, zinc-plated	2	2	600.0000.764
	Soft close, up to 26 kg (57 lbs.)		2	057.3156.072

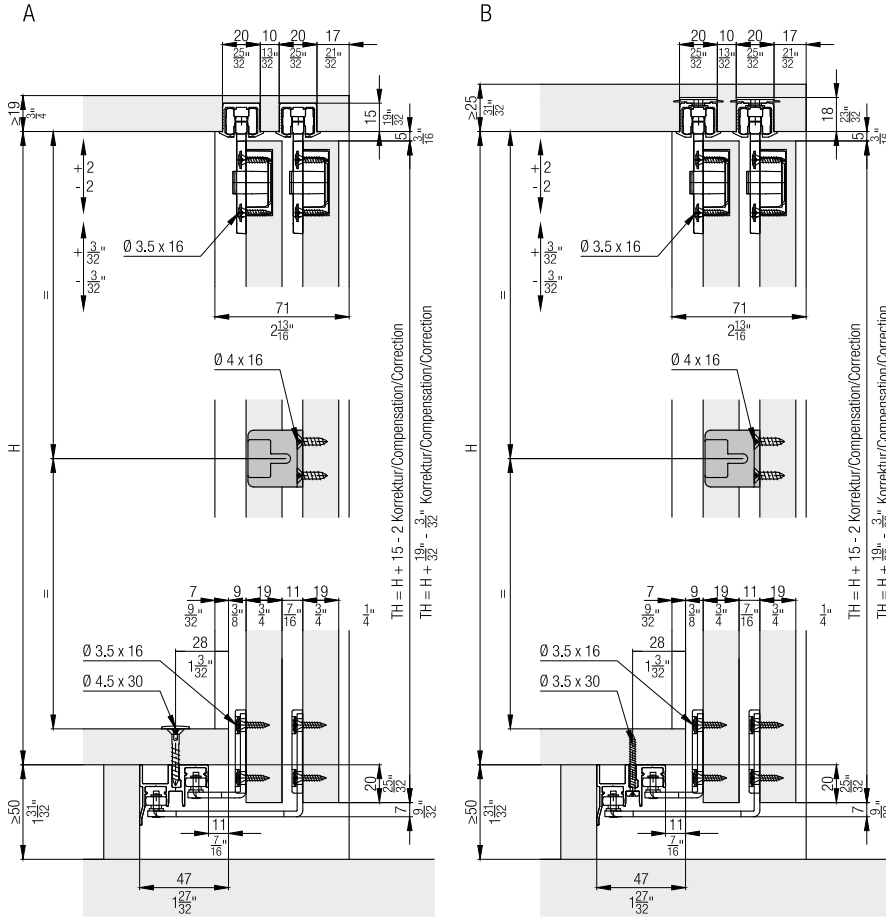
Handle profiles

		mm (inch)	No.
	Handle profile, groove for brush seal, for screw fixing, aluminum, anodized, pre-drilled	2,500 (8' 2 7/16")	055.3140.250
		6,000 (19' 8 7/32")	055.3140.600

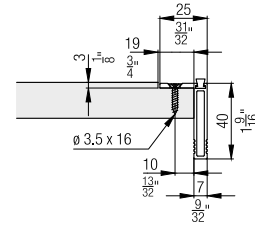
Accessories

		No.
	Track cleaner, plastic, red	040.3142.071

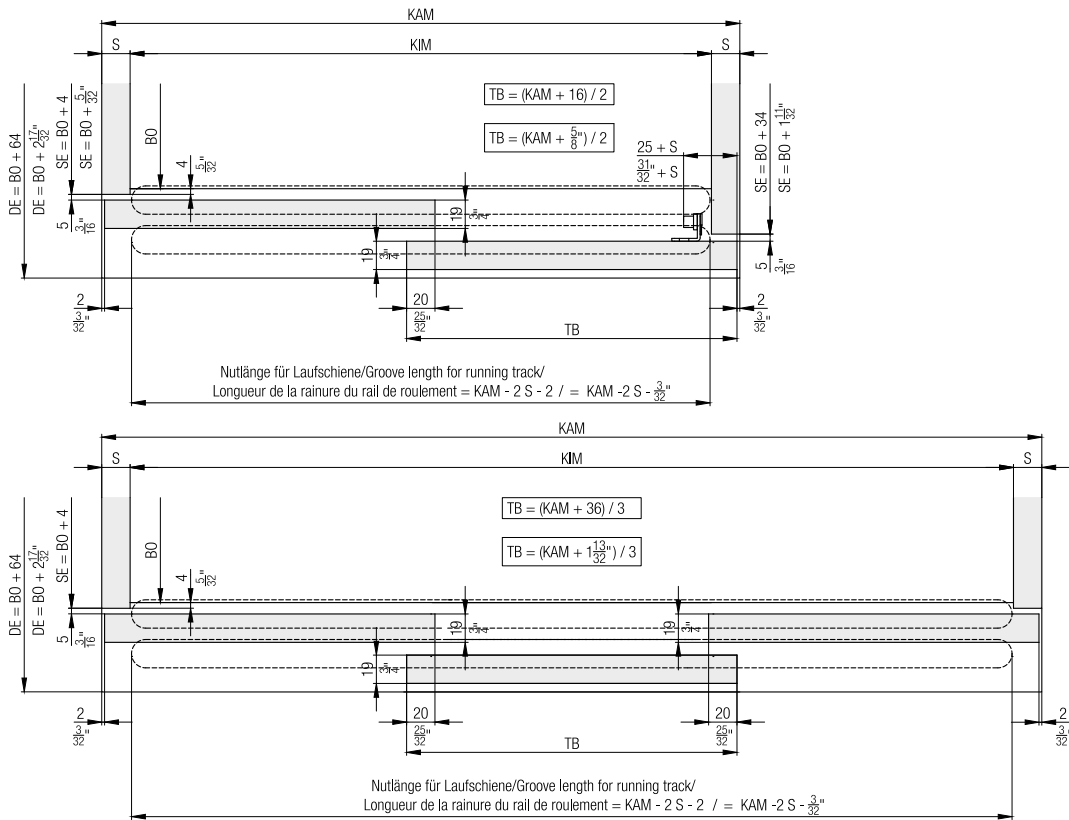
Further installation examples



Handle profiles



Calculations

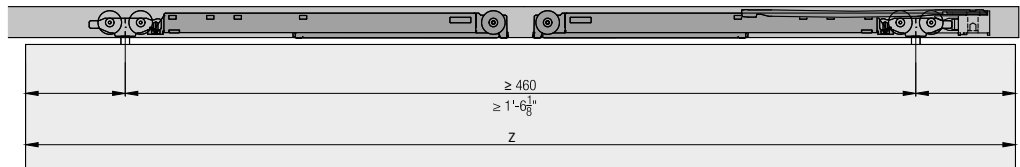
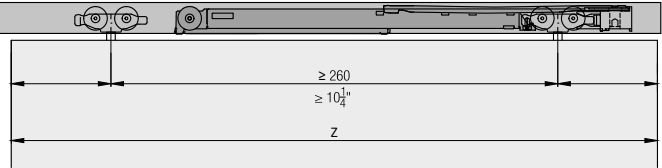


Soft close



	Z ≥	
	1	2
Hawa Porta 40 H	1' 4 $\frac{17}{32}$ "	2' 0 $\frac{13}{32}$ "
Hawa Porta 40 GE	1' 2 $\frac{13}{16}$ "	1' 10 $\frac{11}{16}$ "
Hawa Clipo 26 H IS	1' 4 $\frac{17}{32}$ "	2' 0 $\frac{13}{32}$ "
Hawa Clipo 26 H MS	1' 6 $\frac{1}{32}$ "	2' 1 $\frac{29}{32}$ "
Hawa Clipo 36 H IS	1' 4 $\frac{17}{32}$ "	2' 0 $\frac{13}{32}$ "
Hawa Clipo 36 H MS	1' 6 $\frac{29}{32}$ "	2' 1 $\frac{29}{32}$ "
Hawa Clipo 36 HM IS	1' 4 $\frac{17}{32}$ "	2' 0 $\frac{13}{32}$ "
Hawa Clipo 26 GR IS	1' 4 $\frac{17}{32}$ "	2' 0 $\frac{13}{32}$ "
Hawa Clipo 36 G IS	1' 4 $\frac{17}{32}$ "	2' 0 $\frac{13}{32}$ "
Hawa Clipo 36 GPK IS	1' 4 $\frac{17}{32}$ "	2' 0 $\frac{13}{32}$ "
Hawa Clipo 36 GPPK IS	1' 4 $\frac{17}{32}$ "	2' 0 $\frac{13}{32}$ "
Hawa Regal C 26 HM IS	1' 4 $\frac{17}{32}$ "	2' 0 $\frac{13}{32}$ "
Hawa Regal C 26 GR IS	1' 3 $\frac{3}{4}$ "	1' 11 $\frac{5}{8}$ "

	Z ≥	
	1	2
Hawa Porta 40 H	420	620
Hawa Porta 40 GE	376	576
Hawa Clipo 26 H IS	420	620
Hawa Clipo 26 H MS	458	658
Hawa Clipo 36 H IS	420	620
Hawa Clipo 36 H MS	458	658
Hawa Clipo 36 HM IS	420	620
Hawa Clipo 26 GR IS	420	620
Hawa Clipo 36 G IS	420	620
Hawa Clipo 36 GPK IS	420	620
Hawa Clipo 36 GPPK IS	420	620
Hawa Regal C 26 HM IS	420	620
Hawa Regal C 26 GR IS	400	600



Accessories



– Straightening fitting from page 236

Planning/execution




Further information about the product can be found on www.hawa.com.

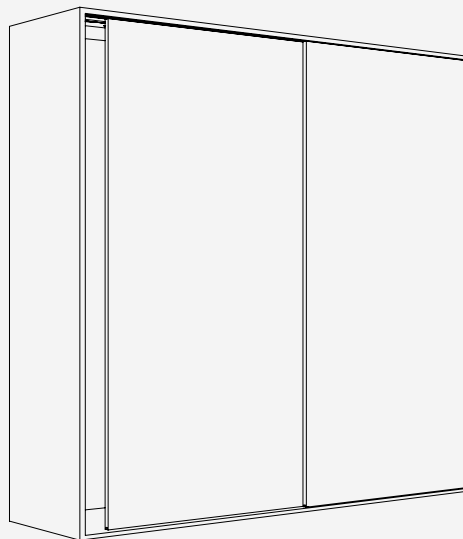
Fitting for 2-3 top-running wooden doors up to 36 kg (79 lbs.), with groove mounted running track. With soft and self closing mechanism. Design Inside.

Product highlights

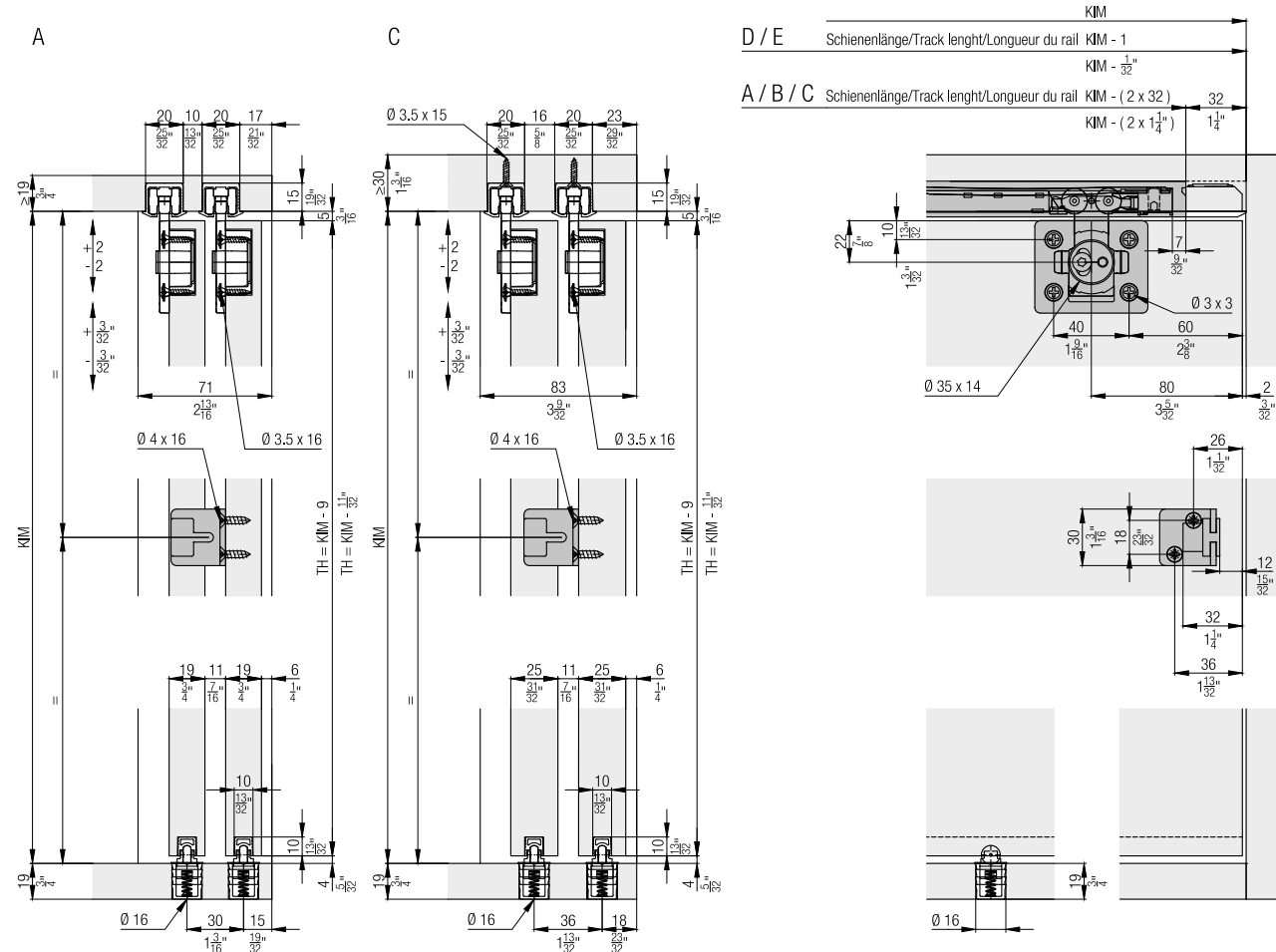
-  **Flexibility** Wide range of applications for sliding door cabinets in any dimension
-  **Productivity** Easy installation with tool-less clip-on system and convenient height adjustment

Technical specifications

-  Max. 36 kg (79 lbs.)
-  Max. 2200 mm (7'2 5/8")
-  Max. 1000 mm (3'3 3/8")
-  19-25 mm (3/4" to 31/32")



Installation examples










**Set for 2 wooden doors up to 36 kg (79 lbs.),
with height adjustment**

	No.
Hawa Clipo 36 H IS, for 2 doors	053.3353.072

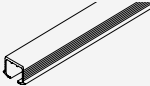
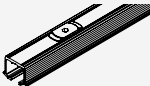
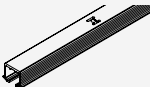


Set consisting of:		053.3353.072	No.
	Running gear double, left	2	053.3346.071
	Running gear double, right	2	053.3347.071
	Stopper, plastic, gray	4	057.3148.071
	Housing, plastic	4	053.0332.001
	Fillister head screw, 3.5x16 mm (5/32"x5/8"), steel, zinc-plated	16	766.6052.100
	Follower Hawa Combino/Hawa Clipo, plastic	1	055.3123.071
	Adapter to follower steel, zinc-plated	1	055.0213.101
	Flat countersunk head chipboard screw 4x16 mm (5/32"x5/8"), steel, zinc-plated	2	600.0000.253
	Bottom guide, plastic, gray	2	055.3081.071

**Set for 3 wooden doors up to 36 kg (79 lbs.),
with height adjustment**




	No.
Hawa Clipo 36 H IS, for 3 doors	053.3353.073

Set consisting of:		053.3353.073	No.
	Running gear double, left	3	053.3346.071
	Running gear double, right	3	053.3347.071
	Stopper, plastic, gray	4	057.3148.071
	Housing, plastic	6	053.0332.001
	Fillister head screw, 3.5x16 mm (5/32"x5/8"), steel, zinc-plated	24	766.6052.100
	Buffer, with adhesive	2	061.3083.001
	Bottom guide, plastic, gray	3	055.3081.071

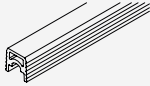
Running tracks

		mm (inch)	No.
	A: Single running track, for glue fixing, aluminum, anodized	2,500 (8' 2 7/16")	053.3324.250
		3,500 (11' 5 25/32")	053.3324.350
		6,000 (19' 8 7/32")	053.3324.600
	B: Single running track, swivel lug, aluminum, anodized (not for hard wood/ MDF)	2,500 (8' 2 7/16")	053.3327.250
		3,500 (11' 5 25/32")	053.3327.350
		6,000 (19' 8 7/32")	053.3327.600
	C: Single running track, for screw fixing, aluminum, anodized	2,500 (8' 2 7/16")	053.3325.250
		3,500 (11' 5 25/32")	053.3325.350
		6,000 (19' 8 7/32")	053.3325.600
	D: Double running track, for screw fixing, aluminum, anodized, for door thickness of 25 mm (31/32")	2,500 (8' 2 7/16")	053.3328.250
		3,500 (11' 5 25/32")	053.3328.350
		6,000 (19' 8 7/32")	053.3328.600
	E: Double running track, for screw fixing, aluminum, anodized, for door thickness of 19 mm (3/4")	2,500 (8' 2 7/16")	053.3339.250
		3,500 (11' 5 25/32")	053.3339.350
		E: Double running track, for screw fixing, aluminum, anodized, for door thickness of 19 mm (3/4")	6,000 (19' 8 7/32")


Track end piece set for single running tracks

		No.	
Track-end section, for screw fixing, plastic, gray, 2-piece set		053.3354.071	
Track-end section, swivel lug, plastic, gray, 2-piece set		053.3355.051	
		053.3354.071	053.3355.051
		No.	
Set consisting of:			
	Track-end piece, for screw fixing, plastic	2	053.0334.001
	Chipboard screw, 4x12 mm (5/32"x15/32"), steel, zinc-plated	2	600.0000.704
	Track-end piece, with swivel lug, plastic	2	053.3351.071

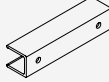
Guide tracks

		mm (inch)	No.
	Guide track, for glue fixing, plastic, gray	2,500 (8' 2 7/16")	055.3171.250
		3,500 (11' 5 25/32")	055.3171.350
		6,000 (19' 8 7/32")	055.3171.600

Panels

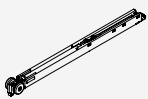


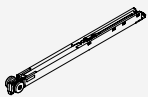
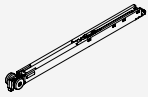
		mm (inch)	No.
	Panel for 053.3339., aluminum, anodized	2,500 (8' 2 7/16")	053.5050.250
		3,500 (11' 5 25/32")	053.5050.350
		6,000 (19' 8 7/32")	053.5050.600

Clip-on components

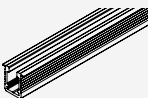
		No.
	Clip component for wooden panel, for 053.3339, every 700-800 mm (2' 3 9/16" to 2' 7 15/32"), aluminum, pre-drilled	053.5051.001

Soft close up to 15/26/36 kg (33/57/79 lbs.)



	No.
Soft close, up to 15 kg (33 lbs.)	057.3159.071
Soft close, up to 26 kg (57 lbs.)	057.3159.072
Soft close, up to 40 kg (88 lbs.)	057.3159.073

Set consisting of:				No.
	057.3159.071	057.3159.072	057.3159.073	
 Soft close, up to 15 kg (33 lbs.)	2			057.3156.071
 Release piece soft close	2	2	2	057.0182.101
 Thread rolling rounded head screw, M2.5x5 mm (3/32"x3/16"), steel, zinc-plated	2	2	2	600.0000.764
 Soft close, up to 26 kg (57 lbs.)		2		057.3156.072
 Soft close, up to 40 kg (88 lbs.)			2	057.3156.073

Guide tracks 4-point guidance




	mm (inch)	No.
 Single guide track, for glue fixing, aluminum, anodized	6,000 (19' 8 7/32")	053.3296.600

Components 4-point guidance


	No.
 Bottom guide Hawa Clipo IS/Hawa Regal C 16, plastic, anthracite	040.3124.071
 Stopper guide track, plastic, grey	053.5094.071

Door centering

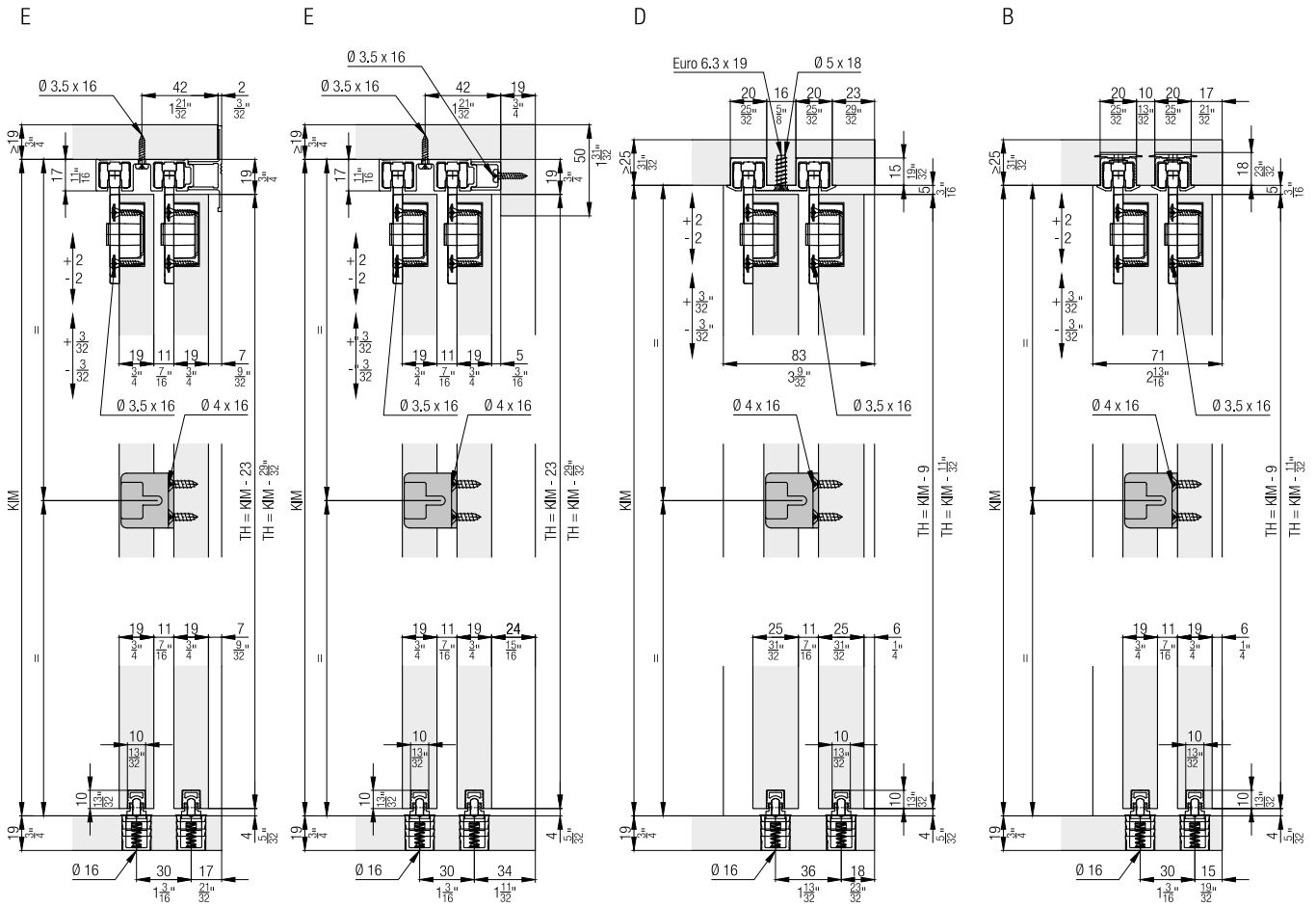
	No.
Door centering, plastic, anthracite, for 2 doors	053.3207.071

Set consisting of:			No.
	053.3207.071		
 Housing door centering, plastic, anthracite	2		053.5014.001
 Pin door centering, plastic, anthracite	2		053.0171.001
 Rubber buffer, plastic, grey	1		025.0107.001

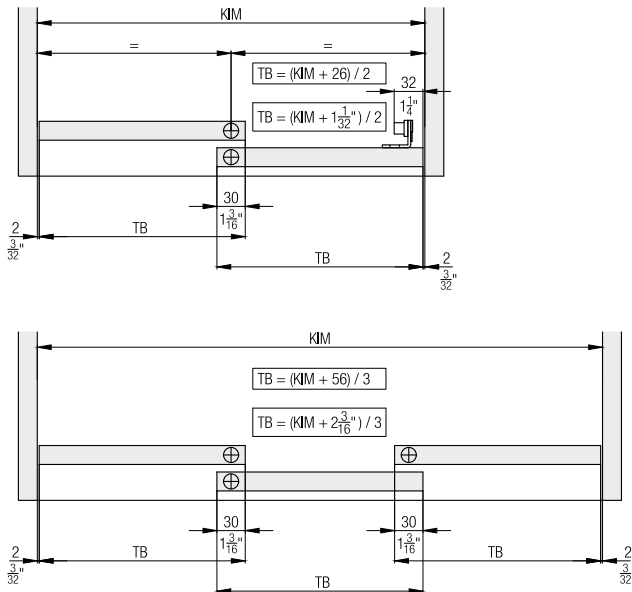
Accessories

	No.
 Track cleaner, plastic, red	040.3142.071

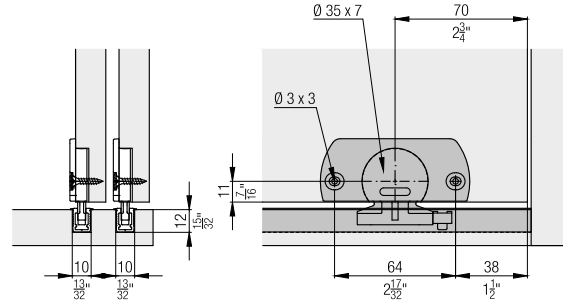
Further installation examples



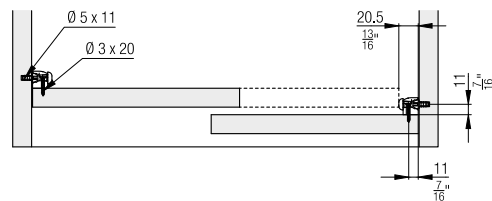
Calculations



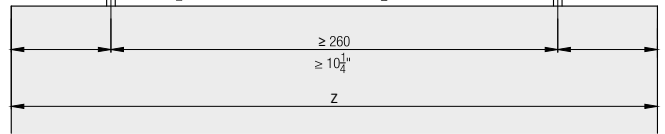
4 point guidance



Door centering

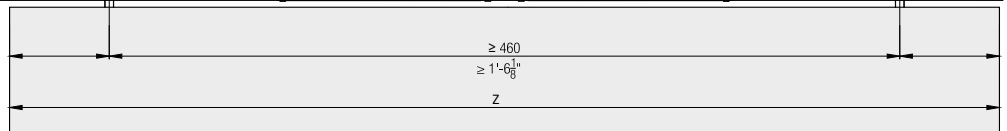


Soft close



	Z ≥	
	1	2
Hawa Porta 40 H	1' 4 ¹⁷ / ₃₂ "	2' 0 ¹³ / ₃₂ "
Hawa Porta 40 GE	1' 2 ¹³ / ₁₆ "	1' 10 ¹¹ / ₁₆ "
Hawa Clipo 26 H IS	1' 4 ¹⁷ / ₃₂ "	2' 0 ¹³ / ₃₂ "
Hawa Clipo 26 H MS	1' 6 ¹ / ₃₂ "	2' 1 ²⁹ / ₃₂ "
Hawa Clipo 36 H IS	1' 4 ¹⁷ / ₃₂ "	2' 0 ¹³ / ₃₂ "
Hawa Clipo 36 H MS	1' 6 ¹ / ₃₂ "	2' 1 ²⁹ / ₃₂ "
Hawa Clipo 36 HM IS	1' 4 ¹⁷ / ₃₂ "	2' 0 ¹³ / ₃₂ "
Hawa Clipo 26 GR IS	1' 4 ¹⁷ / ₃₂ "	2' 0 ¹³ / ₃₂ "
Hawa Clipo 36 G IS	1' 4 ¹⁷ / ₃₂ "	2' 0 ¹³ / ₃₂ "
Hawa Clipo 36 GPK IS	1' 4 ¹⁷ / ₃₂ "	2' 0 ¹³ / ₃₂ "
Hawa Clipo 36 GPPK IS	1' 4 ¹⁷ / ₃₂ "	2' 0 ¹³ / ₃₂ "
Hawa Regal C 26 HM IS	1' 4 ¹⁷ / ₃₂ "	2' 0 ¹³ / ₃₂ "
Hawa Regal C 26 GR IS	1' 3 ³ / ₄ "	1' 11 ⁵ / ₈ "

	Z ≥	
	1	2
Hawa Porta 40 H	420	620
Hawa Porta 40 GE	376	576
Hawa Clipo 26 H IS	420	620
Hawa Clipo 26 H MS	458	658
Hawa Clipo 36 H IS	420	620
Hawa Clipo 36 H MS	458	658
Hawa Clipo 36 HM IS	420	620
Hawa Clipo 26 GR IS	420	620
Hawa Clipo 36 G IS	420	620
Hawa Clipo 36 GPK IS	420	620
Hawa Clipo 36 GPPK IS	420	620
Hawa Regal C 26 HM IS	420	620
Hawa Regal C 26 GR IS	400	600



Accessories



– Straightening fitting from page 236

Planning/execution





Further information about the product can be found on www.hawa.com.

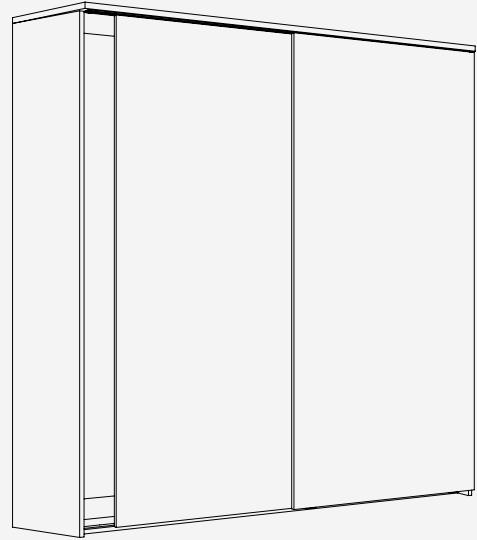
Fitting for 2-3 top-running wooden doors up to 36 kg (79 lbs.), with groove mounted running track. With soft and self closing mechanism. Design Mixslide.

Product highlights

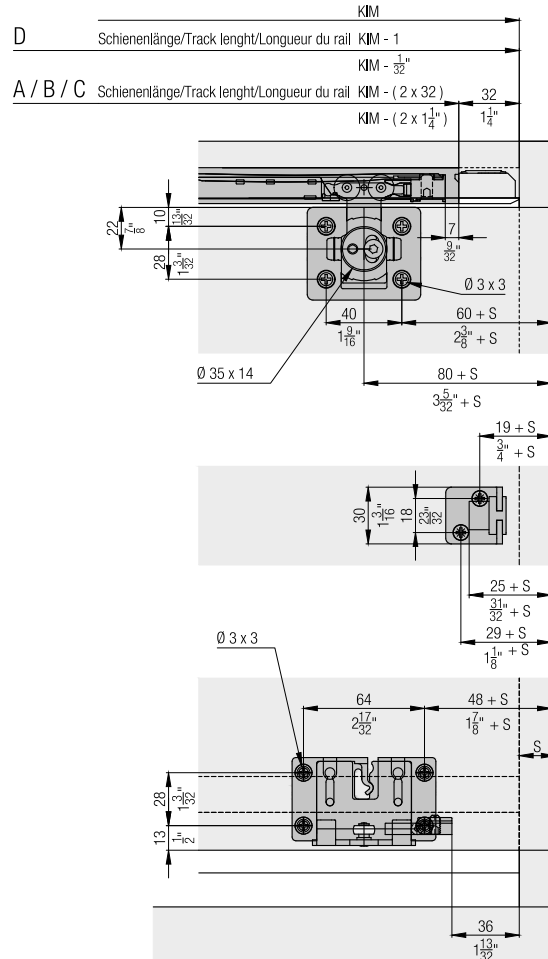
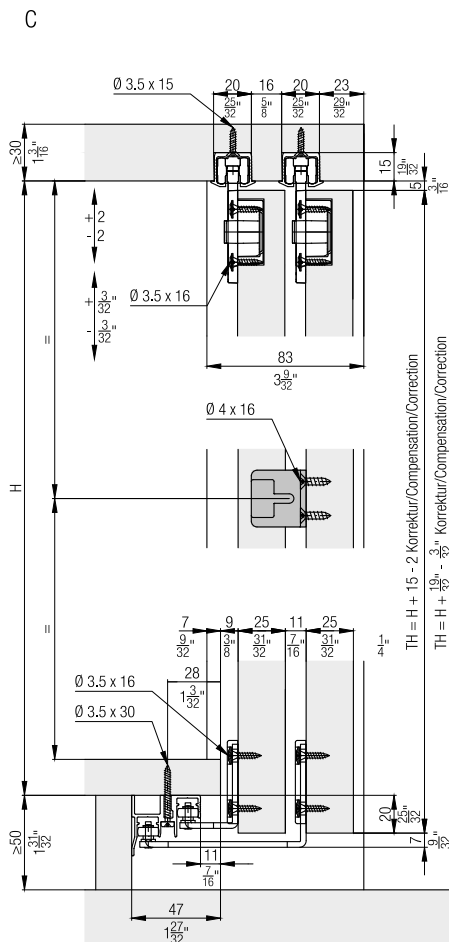
-  **Comfort** Quiet, smooth running and soft and self closing system for different door weights
-  **Productivity** Easy installation with tool-less clip-on system and convenient height adjustment

Technical specifications













-  Max. 36 kg (79 lbs.)
-  Max. 2400 mm (7'10 7/16")
-  Max. 1000 mm (3'3 3/8")
-  25 mm (31/32")



Installation examples



**Set for 2 wooden doors up to 36 kg (79 lbs.),
with height adjustment**

		No.	
Hawa Clipo 36 H MS, for 2 doors		053.3357.071	
		053.3357.071	No.
Set consisting of:			
	Running gear double, left	2	053.3346.071
	Running gear double, right	2	053.3347.071
	Stopper, plastic, gray	4	057.3148.071
	Housing, plastic	4	053.0332.001
	Fillister head screw, 3.5x16 mm (5/32"x5/8"), steel, zinc-plated	32	766.6052.100
	Follower Hawa Combino/Hawa Clipo, plastic	1	055.3123.071
	Adapter to follower steel, zinc-plated	1	055.0213.101
	Flat countersunk head chipboard screw 4x16 mm (5/32"x5/8"), steel, zinc-plated	2	600.0000.253
	Guide bracket, interior door, steel, zinc-plated	2	055.3107.171
	Guide bracket, exterior door, 25 mm (31/32"), steel, zinc-plated	2	055.3110.171
	Guide bracket housing, plastic, anthracite	4	053.3064.001
	Stopper guide, plastic, gray	4	040.3079.074

**Set for 3 wooden doors up to 36 kg (79 lbs.),
with height adjustment**

		No.	
Hawa Clipo 36 H MS, for 3 doors		053.3357.072	
		053.3357.072	No.
Set consisting of:			
	Running gear double, left	3	053.3346.071
	Running gear double, right	3	053.3347.071
	Stopper, plastic, gray	4	057.3148.071
	Housing, plastic	6	053.0332.001
	Fillister head screw, 3.5x16 mm (5/32"x5/8"), steel, zinc-plated	48	766.6052.100
	Buffer, with adhesive	2	061.3083.001
	Guide bracket, interior door, steel, zinc-plated	4	055.3107.171
	Guide bracket, exterior door, 25 mm (31/32"), steel, zinc-plated	2	055.3110.171
	Guide bracket housing, plastic, anthracite	6	053.3064.001
	Door follower, steel, zinc-plated, with 3 doors	2	055.3126.171
	Thread-cutting rounded head screw, M4x8 mm (5/32"x5/16"), steel, zinc-plated	2	600.0000.328
	Stopper guide, plastic, gray	4	040.3079.074




Running tracks

		mm (inch)	No.
	A: Single running track, for glue fixing, aluminum, anodized	2,500 (8' 2 7/16")	053.3324.250
		3,500 (11' 5 25/32")	053.3324.350
		6,000 (19' 8 7/32")	053.3324.600
	B: Single running track, swivel lug, aluminum, anodized (not for hard wood/ MDF)	2,500 (8' 2 7/16")	053.3327.250
		3,500 (11' 5 25/32")	053.3327.350
		6,000 (19' 8 7/32")	053.3327.600
	C: Single running track, for screw fixing, aluminum, anodized	2,500 (8' 2 7/16")	053.3325.250
		3,500 (11' 5 25/32")	053.3325.350
		6,000 (19' 8 7/32")	053.3325.600
	D: Double running track, for screw fixing, aluminum, anodized, for door thickness of 25 mm (31/32")	2,500 (8' 2 7/16")	053.3328.250
		3,500 (11' 5 25/32")	053.3328.350
		6,000 (19' 8 7/32")	053.3328.600

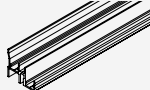
Track end piece set for single running tracks

		No.
Track-end section, for screw fixing, plastic, gray, 2-piece set		053.3354.071
Track-end section, swivel lug, plastic, gray, 2-piece set		053.3355.051

Set consisting of:

		053.3354.071	053.3355.051	No.
	Track-end piece, for screw fixing, plastic	2		053.0334.001
	Chipboard screw, 4x12 mm (5/32"x15/32"), steel, zinc-plated	2		600.0000.704
	Track-end piece, with swivel lug, plastic		2	053.3351.071

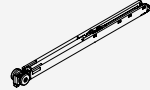


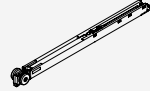
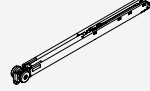
Guide tracks

		mm (inch)	No.
	Double guide track, for screw fixing, aluminum, anodized, pre-drilled	2,500 (8' 2 7/16")	056.3072.250
		3,500 (11' 5 25/32")	056.3072.350
		6,000 (19' 8 7/32")	056.3072.600


Soft close up to 15/26/36 kg (33/57/79 lbs.)

		No.
Soft close, up to 15 kg (33 lbs.)		057.3159.071
Soft close, up to 26 kg (57 lbs.)		057.3159.072
Soft close, up to 40 kg (88 lbs.)		057.3159.073


Set consisting of:

		057.3159.071	057.3159.072	057.3159.073	No.
	Soft close, up to 15 kg (33 lbs.)	2			057.3156.071
	Release piece soft close	2	2	2	057.0182.101
	Thread rolling rounded head screw, M2.5x5 mm (3/32"x3/16"), steel, zinc-plated	2	2	2	600.0000.764
	Soft close, up to 26 kg (57 lbs.)		2		057.3156.072
	Soft close, up to 40 kg (88 lbs.)			2	057.3156.073

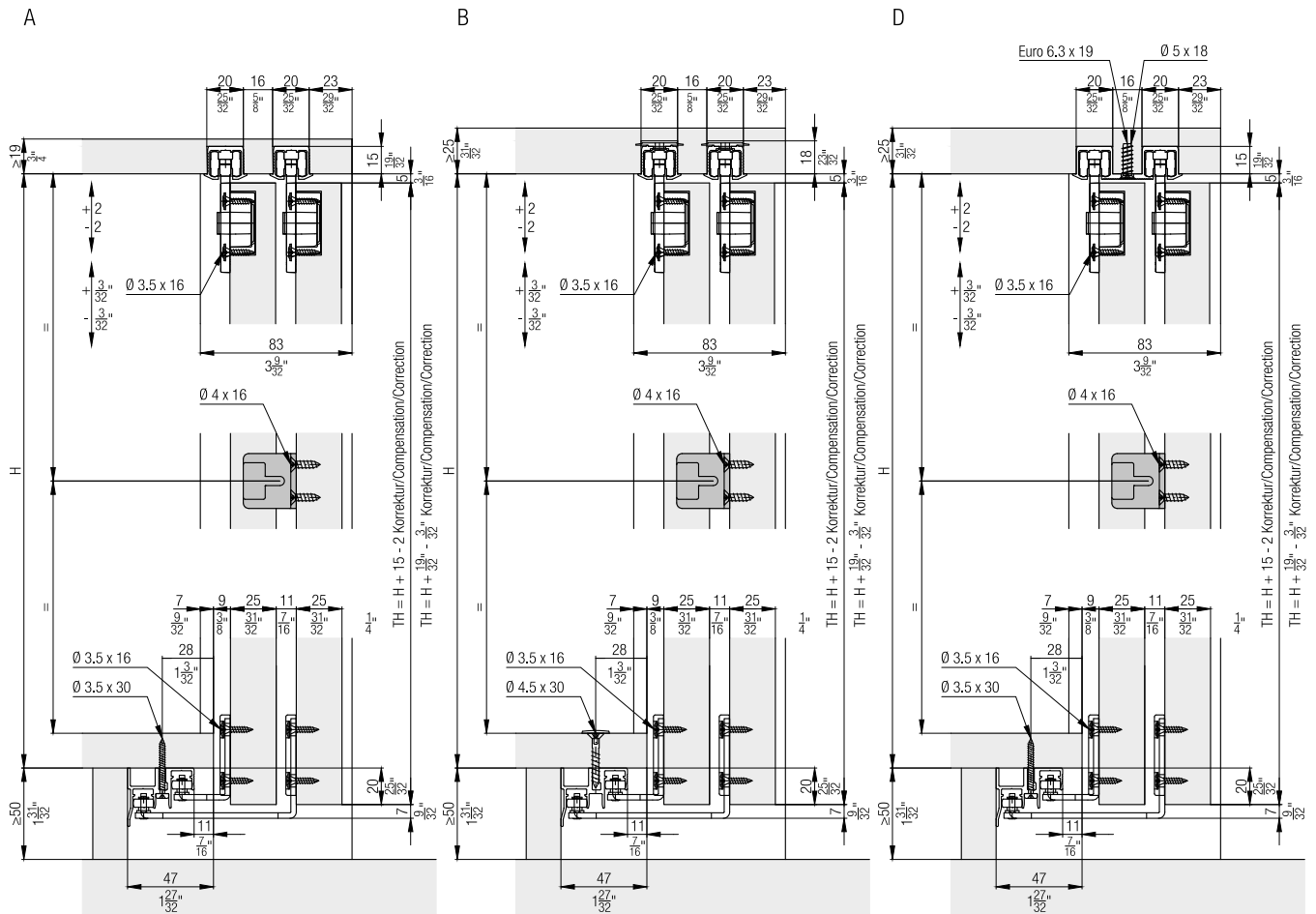
Handle profiles

		mm (inch)	No.
	Handle profile, groove for brush seal, for screw fixing, aluminum, anodized, pre-drilled	2,500 (8' 2 7/16")	055.3140.250
		6,000 (19' 8 7/32")	055.3140.600

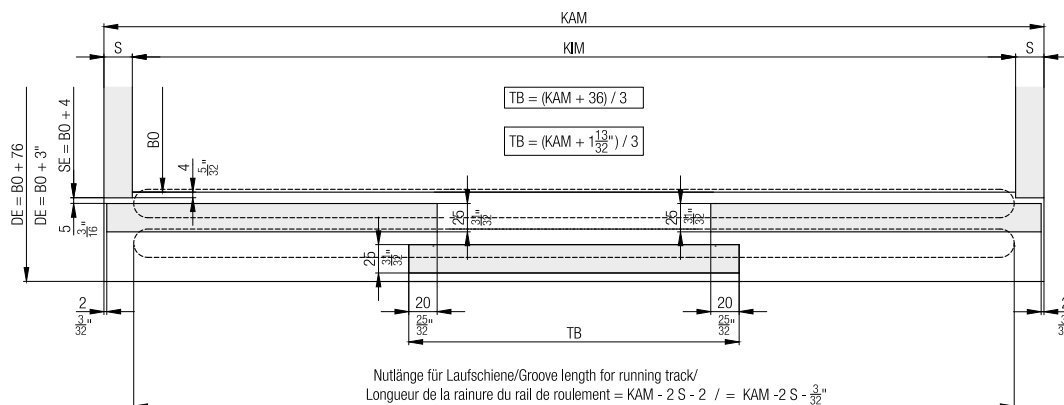
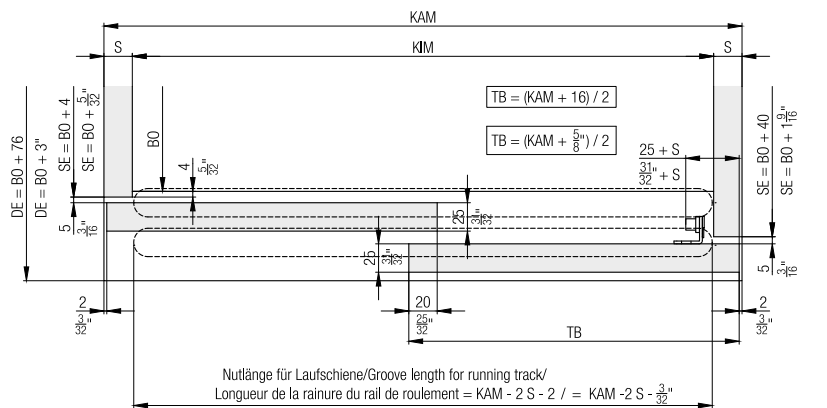
Accessories

		No.
	Track cleaner, plastic, red	040.3142.071

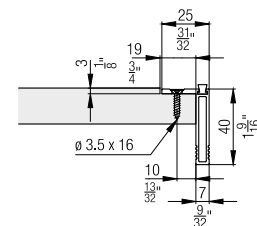
Further installation examples



Calculations



Handle profiles

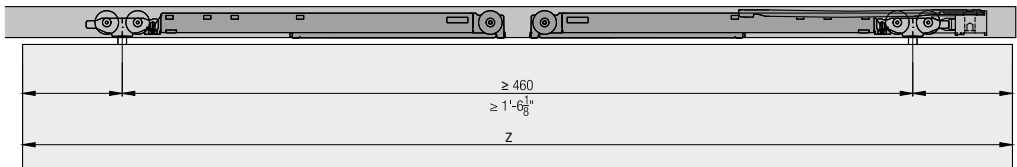
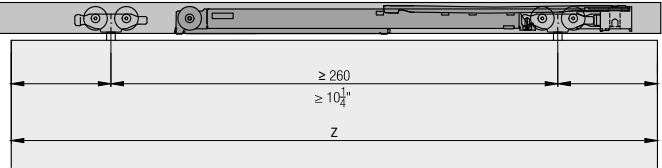


Soft close



	Z ≥	
	1	2
Hawa Porta 40 H	1' 4 $\frac{17}{32}$ "	2' 0 $\frac{13}{32}$ "
Hawa Porta 40 GE	1' 2 $\frac{13}{16}$ "	1' 10 $\frac{11}{16}$ "
Hawa Clipo 26 H IS	1' 4 $\frac{17}{32}$ "	2' 0 $\frac{13}{32}$ "
Hawa Clipo 26 H MS	1' 6 $\frac{1}{32}$ "	2' 1 $\frac{29}{32}$ "
Hawa Clipo 36 H IS	1' 4 $\frac{17}{32}$ "	2' 0 $\frac{13}{32}$ "
Hawa Clipo 36 H MS	1' 6 $\frac{31}{32}$ "	2' 1 $\frac{29}{32}$ "
Hawa Clipo 36 HM IS	1' 4 $\frac{17}{32}$ "	2' 0 $\frac{13}{32}$ "
Hawa Clipo 26 GR IS	1' 4 $\frac{17}{32}$ "	2' 0 $\frac{13}{32}$ "
Hawa Clipo 36 G IS	1' 4 $\frac{17}{32}$ "	2' 0 $\frac{13}{32}$ "
Hawa Clipo 36 GPK IS	1' 4 $\frac{17}{32}$ "	2' 0 $\frac{13}{32}$ "
Hawa Clipo 36 GPPK IS	1' 4 $\frac{17}{32}$ "	2' 0 $\frac{13}{32}$ "
Hawa Regal C 26 HM IS	1' 4 $\frac{17}{32}$ "	2' 0 $\frac{13}{32}$ "
Hawa Regal C 26 GR IS	1' 3 $\frac{3}{4}$ "	1' 11 $\frac{5}{8}$ "

	Z ≥	
	1	2
Hawa Porta 40 H	420	620
Hawa Porta 40 GE	376	576
Hawa Clipo 26 H IS	420	620
Hawa Clipo 26 H MS	458	658
Hawa Clipo 36 H IS	420	620
Hawa Clipo 36 H MS	458	658
Hawa Clipo 36 HM IS	420	620
Hawa Clipo 26 GR IS	420	620
Hawa Clipo 36 G IS	420	620
Hawa Clipo 36 GPK IS	420	620
Hawa Clipo 36 GPPK IS	420	620
Hawa Regal C 26 HM IS	420	620
Hawa Regal C 26 GR IS	400	600



Accessories

– Straightening fitting from page 236

Planning/execution

Further information about the product can be found on www.hawa.com.

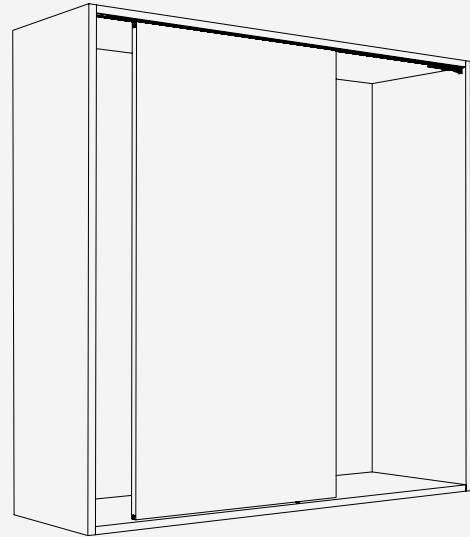
Fitting for 1-2 top-running wooden doors up to 36 kg (79 lbs.), with groove mounted running track. With soft and self closing mechanism. Design Inside.

Product highlights

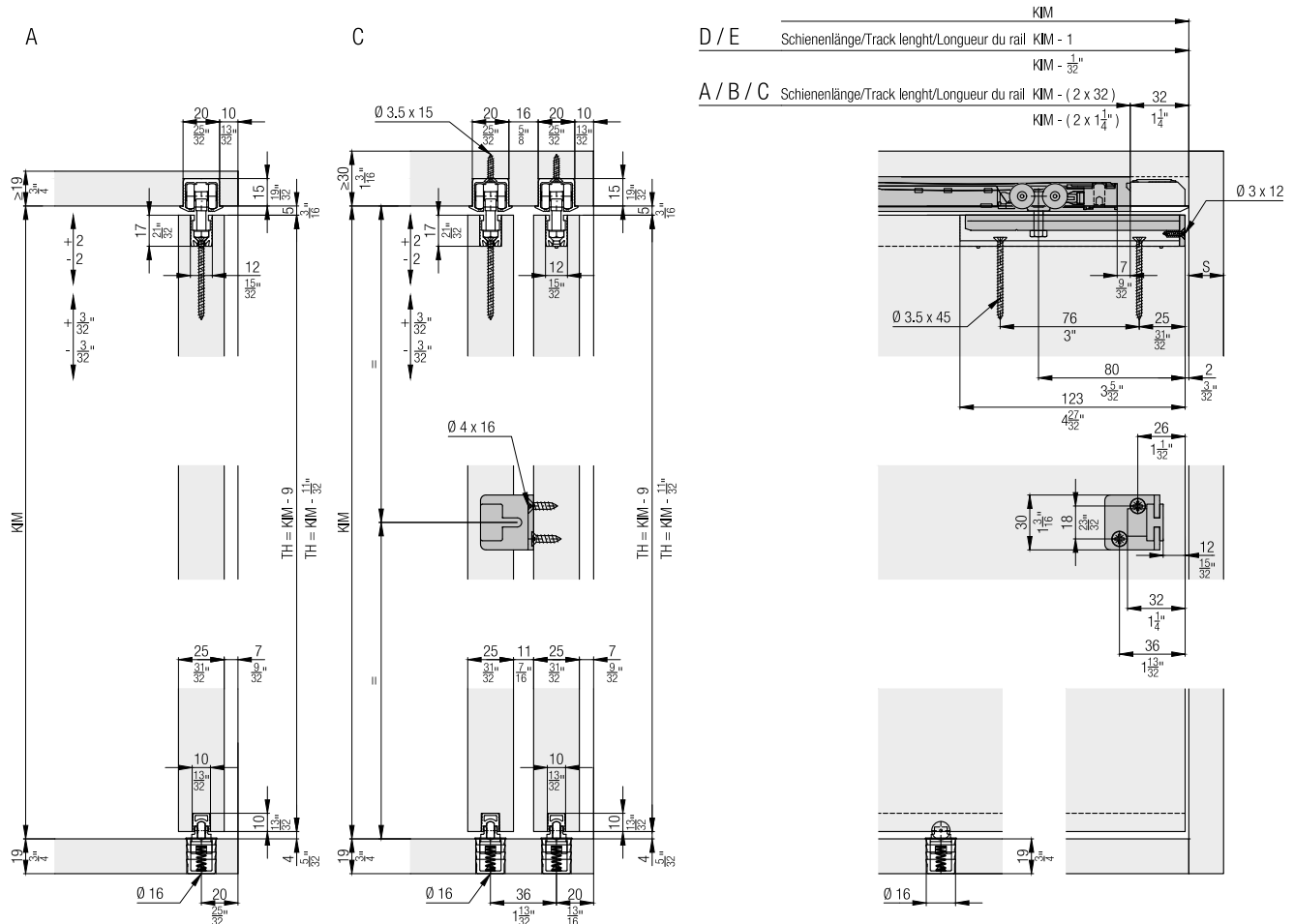
- Aesthetics** Optimum solution for serving hatches thanks to the lateral, concealed running system
- Flexibility** Wide range of applications for sliding door cabinets in any dimension

Technical specifications

- Max. 36 kg (79 lbs.)
- Max. 2400 mm (7'10 7/16")
- Max. 1000 mm (3'3 3/8")
- 19-40 mm (3/4" to 1 9/16")



Installation examples



**Set for 1 wooden door up to 36 kg (79 lbs.),
with height adjustment
Always order 2 sets with 2 doors.**

	No.
Hawa Clipo 36 HM IS, for 1 door	053.3358.071

Set consisting of:




		053.3358.071	No.
	Running gear	2	053.3343.071
	Flat countersunk head chipboard screw, 3x12 mm (1/8 "x 15/32"), steel, zinc-plated, black	2	600.0000.703
	Stopper, plastic, gray	2	057.3148.071
	Housing, aluminum	2	053.3073.007
	Flat countersunk head chipboard screw 3.5x45 mm (5/32"x1 25/32"), steel, zinc-plated	4	600.0000.706
	Bottom guide, plastic, gray	1	055.3081.071

Door follower

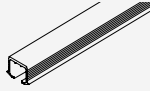
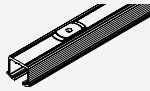
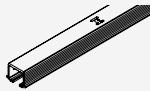
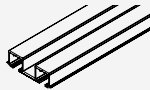
Order 1 set with 2 doors.

	No.
Door follower, steel, zinc-plated, with 2 doors	055.3124.071

Set consisting of:

		055.3124.071	No.
	Follower Hawa Combino/ Hawa Clipo, plastic	1	055.3123.071
	Adapter to follower steel, zinc-plated	1	055.0213.101
	Flat countersunk head chipboard screw 4x16 mm (5/32"x5/8"), steel, zinc-plated	2	600.0000.253




Running tracks

		mm (inch)	No.
	A: Single running track, for glue fixing, aluminum, anodized	2,500 (8' 2 7/16")	053.3324.250
		3,500 (11' 5 25/32")	053.3324.350
		6,000 (19' 8 7/32")	053.3324.600
	B: Single running track, swivel lug, aluminum, anodized (not for hard wood/ MDF)	2,500 (8' 2 7/16")	053.3327.250
		3,500 (11' 5 25/32")	053.3327.350
		6,000 (19' 8 7/32")	053.3327.600
	C: Single running track, for screw fixing, aluminum, anodized	2,500 (8' 2 7/16")	053.3325.250
		3,500 (11' 5 25/32")	053.3325.350
		6,000 (19' 8 7/32")	053.3325.600
	D: Double running track, for screw fixing, aluminum, anodized, for door thickness of 25 mm (31/32")	2,500 (8' 2 7/16")	053.3328.250
		3,500 (11' 5 25/32")	053.3328.350
		6,000 (19' 8 7/32")	053.3328.600
	E: Double running track, for screw fixing, aluminum, anodized, for door thickness of 19 mm (3/4")	2,500 (8' 2 7/16")	053.3339.250
		3,500 (11' 5 25/32")	053.3339.350
		6,000 (19' 8 7/32")	053.3339.600

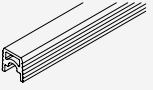
Track end piece set for single running tracks

	No.
Track-end section, for screw fixing, plastic, gray, 2-piece set	053.3354.071
Track-end section, swivel lug, plastic, gray, 2-piece set	053.3355.051

Set consisting of:

	053.3354.071	053.3355.051	No.
 Track-end piece, for screw fixing, plastic	2		053.0334.001
 Chipboard screw, 4x12 mm (5/32"x15/32"), steel, zinc-plated	2		600.0000.704
 Track-end piece, with swivel lug, plastic		2	053.3351.071

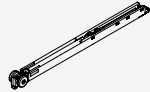


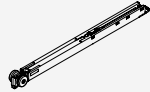
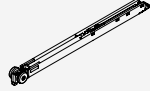
Guide tracks

	mm (inch)	No.
	2,500 (8' 2 7/16")	055.3171.250
	3,500 (11' 5 25/32")	055.3171.350
	6,000 (19' 8 7/32")	055.3171.600

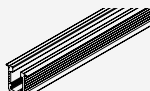
Soft close up to 15/26/36 kg (33/57/79 lbs.)

	No.
Soft close, up to 15 kg (33 lbs.)	057.3159.071
Soft close, up to 26 kg (57 lbs.)	057.3159.072
Soft close, up to 40 kg (88 lbs.)	057.3159.073



Set consisting of:

	057.3159.071	057.3159.072	057.3159.073	No.
 Soft close, up to 15 kg (33 lbs.)	2			057.3156.071
 Release piece soft close	2	2	2	057.0182.101
 Thread rolling rounded head screw, M2.5x5 mm (3/32"x3/16"), steel, zinc-plated	2	2	2	600.0000.764
 Soft close, up to 26 kg (57 lbs.)		2		057.3156.072
 Soft close, up to 40 kg (88 lbs.)			2	057.3156.073

Guide tracks 4-point guidance




	mm (inch)	No.
 Single guide track, for glue fixing, aluminum, anodized	6,000 (19' 8 7/32")	053.3296.600

Components 4-point guidance


	No.
 Bottom guide Hawa Clipo IS/Hawa Regal C 16, plastic, anthracite	040.3124.071
 Stopper guide track, plastic, grey	053.5094.071

Door centering

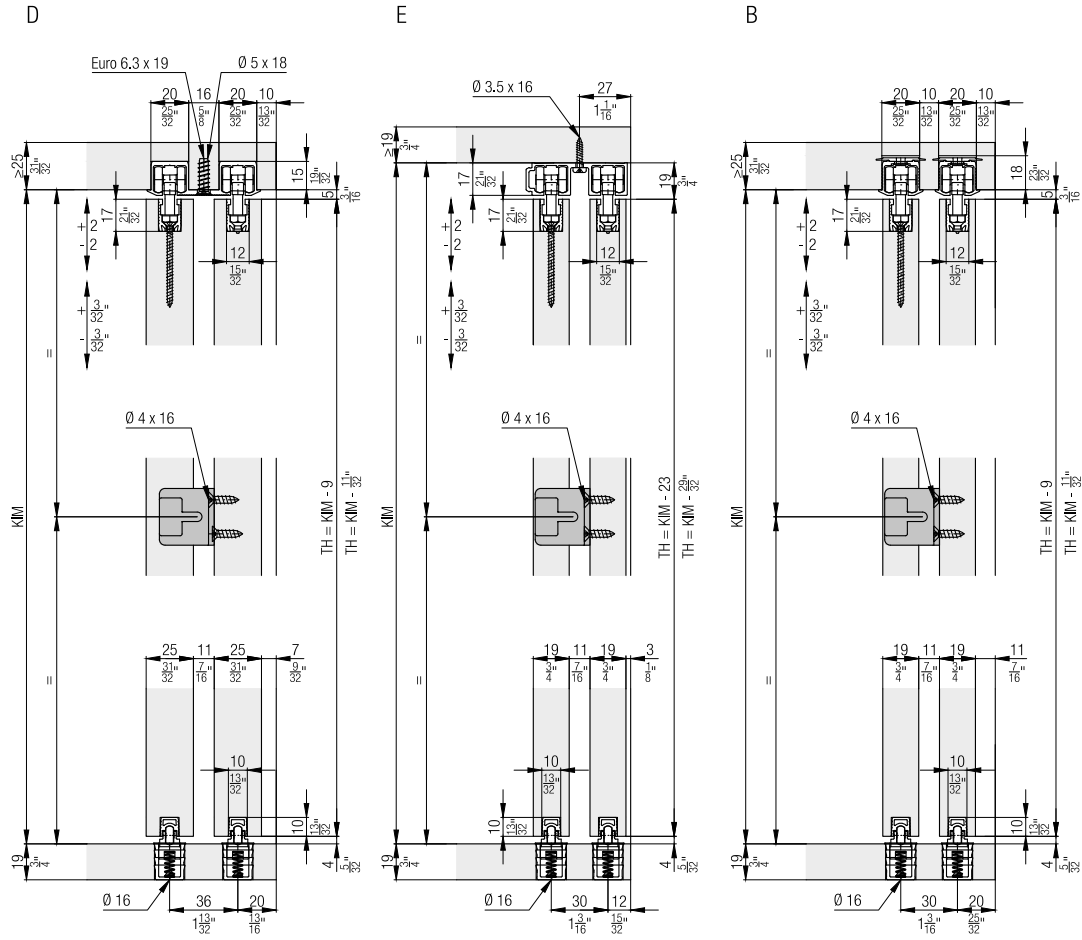
	No.
Door centering, plastic, anthracite, for 2 doors	053.3207.071

Set consisting of:		053.3207.071	No.
	Housing door centering, plastic, anthracite	2	053.5014.001
	Pin door centering, plastic, anthracite	2	053.0171.001
	Rubber buffer, plastic, grey	1	025.0107.001

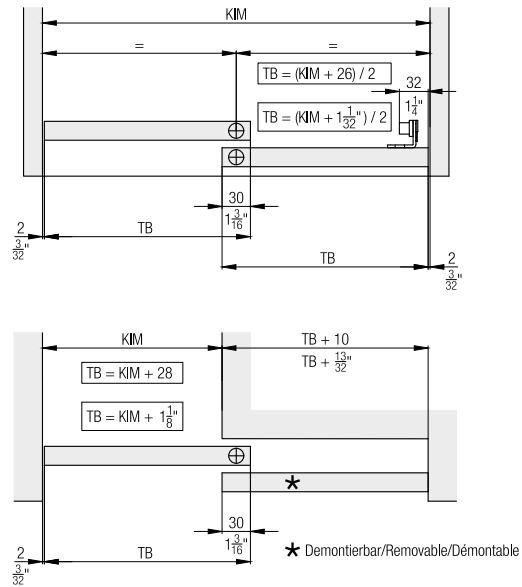
Accessories

	No.	
	Track cleaner, plastic, red	040.3142.071

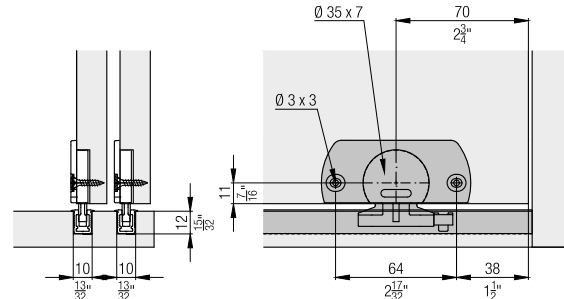
Further installation examples



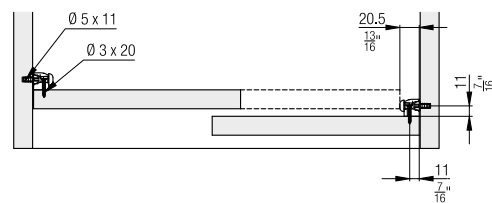
Calculations



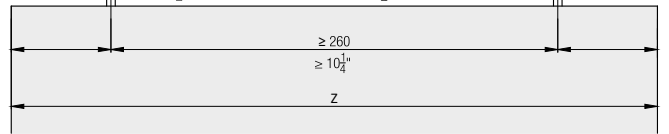
4 point guidance



Door centering

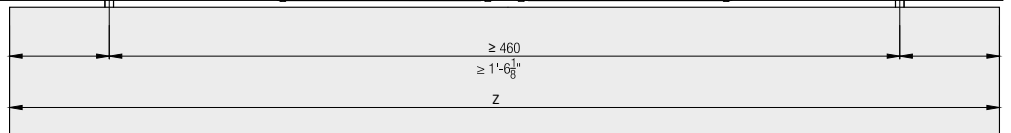


Soft close



	Z ≥	
	1	2
Hawa Porta 40 H	1' 4 ¹⁷ / ₃₂ "	2' 0 ¹³ / ₃₂ "
Hawa Porta 40 GE	1' 2 ¹³ / ₁₆ "	1' 10 ¹¹ / ₁₆ "
Hawa Clipo 26 H IS	1' 4 ¹⁷ / ₃₂ "	2' 0 ¹³ / ₃₂ "
Hawa Clipo 26 H MS	1' 6 ¹ / ₃₂ "	2' 1 ²⁹ / ₃₂ "
Hawa Clipo 36 H IS	1' 4 ¹⁷ / ₃₂ "	2' 0 ¹³ / ₃₂ "
Hawa Clipo 36 H MS	1' 6 ¹ / ₃₂ "	2' 1 ²⁹ / ₃₂ "
Hawa Clipo 36 HM IS	1' 4 ¹⁷ / ₃₂ "	2' 0 ¹³ / ₃₂ "
Hawa Clipo 26 GR IS	1' 4 ¹⁷ / ₃₂ "	2' 0 ¹³ / ₃₂ "
Hawa Clipo 36 G IS	1' 4 ¹⁷ / ₃₂ "	2' 0 ¹³ / ₃₂ "
Hawa Clipo 36 GPK IS	1' 4 ¹⁷ / ₃₂ "	2' 0 ¹³ / ₃₂ "
Hawa Clipo 36 GPPK IS	1' 4 ¹⁷ / ₃₂ "	2' 0 ¹³ / ₃₂ "
Hawa Regal C 26 HM IS	1' 4 ¹⁷ / ₃₂ "	2' 0 ¹³ / ₃₂ "
Hawa Regal C 26 GR IS	1' 3 ³ / ₄ "	1' 11 ⁵ / ₈ "

	Z ≥	
	1	2
Hawa Porta 40 H	420	620
Hawa Porta 40 GE	376	576
Hawa Clipo 26 H IS	420	620
Hawa Clipo 26 H MS	458	658
Hawa Clipo 36 H IS	420	620
Hawa Clipo 36 H MS	458	658
Hawa Clipo 36 HM IS	420	620
Hawa Clipo 26 GR IS	420	620
Hawa Clipo 36 G IS	420	620
Hawa Clipo 36 GPK IS	420	620
Hawa Clipo 36 GPPK IS	420	620
Hawa Regal C 26 HM IS	420	620
Hawa Regal C 26 GR IS	400	600



Accessories

– Straightening fitting from page 236

Planning/execution

Further information about the product can be found on www.hawa.com.

Hawa Concepta for wooden folding/sliding doors

A new dimension in furniture design

With Hawa Concepta 25/30/40/50 doors can be pivoted by 90° and slid into the side of furniture cabinets or wall niches. This opens up completely new perspectives for walk-in closets, floor-to-ceiling constructions and other storage solutions. Because the doors stored away at the side only take up a minimal niche width in the cabinet interior. This solution also impresses with its intelligent technology. That way, it can cope with the majority of dimensions.





It fulfills creative design wishes with a wide range of design options, profiles and handles. And the Hawa Concepta doesn't throw you a curve during installation, either: Apart from drill holes for positioning and concealed hinges, no other processing is required, since the components are screwed to the intermediate panel and are accessible from the front at all times for adjustment.







Area of application

Furniture constructions for multi-functional room usage such as working areas, washer/dryer combinations, cabinets which can be walked into without obstructions, and even entire kitchens which disappear behind pivot slide-in doors.

System advantages

-  **Flexibility** **Easy adaptation** for wide range of door dimensions
Can be combined with Hawa Folding Concepta to create three-leaf front panels without separating walls
-  **Productivity** **Efficient installation**, because all components are screwed to the intermediate panel
-  **Comfort** **No obstruction** by protruding doors
Guide with zero clearance and door pull-in with soft closing mechanism
Intermittent guide brushes for various door widths
-  **Aesthetics** Elegant **flush-fitting, floor-to-ceiling** and **walk-in** construction versions possible

Technical specifications

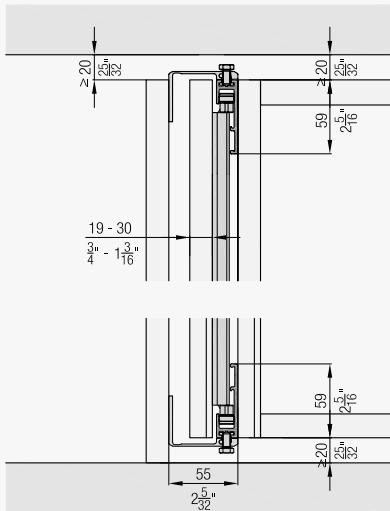
-  max. 25/30/40/50 kg
-  1250–2850 mm
-  300–900 mm
-  19–50 mm

Good to know (accessories)

- Connector makes overlaid furniture structures possible
- Straightening fitting for doors

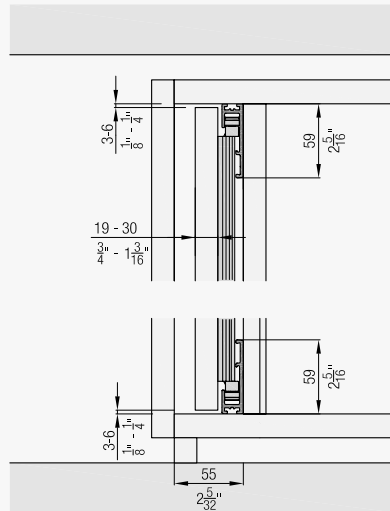
Installation examples

Hawa Concepta 25/30



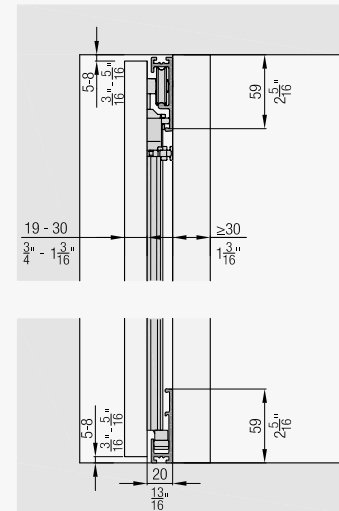
Door striking against the shelf and cabinet top

Hawa Concepta 25/30

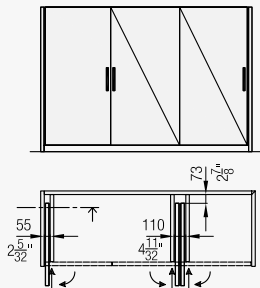


Inset door

Hawa Concepta 25/30

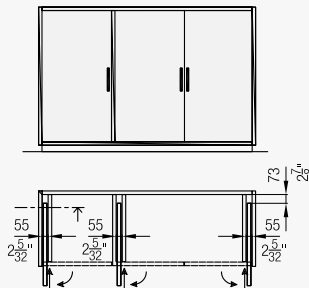


Floor-to-ceiling door, walk-in

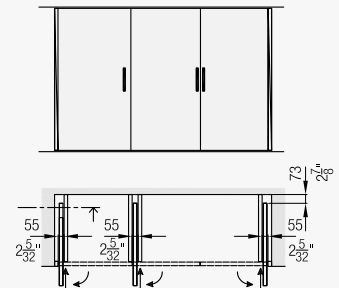


Product range

Hawa Concepta 25/30
Hawa Concepta 40/50





Hawa Concepta 25/30
Hawa Concepta 40/50







Hawa Concepta 25/30
Hawa Concepta 40/50

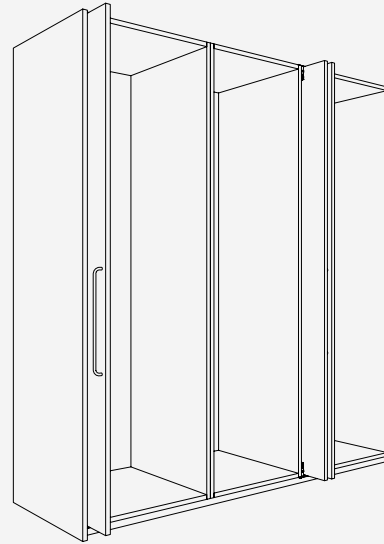
Fitting for pivoting and lateral sliding in of wooden doors up to 25 kg (55 lbs.). Enables multi-functional room design, paired with a flush-fitting design.

Product highlights

-  **Flexibility** Tremendous flexible door dimensions provides a high degree of design freedom
-  **Comfort** Easy, quiet operation thanks to soft closing mechanism and hinges with integrated soft closing mechanism

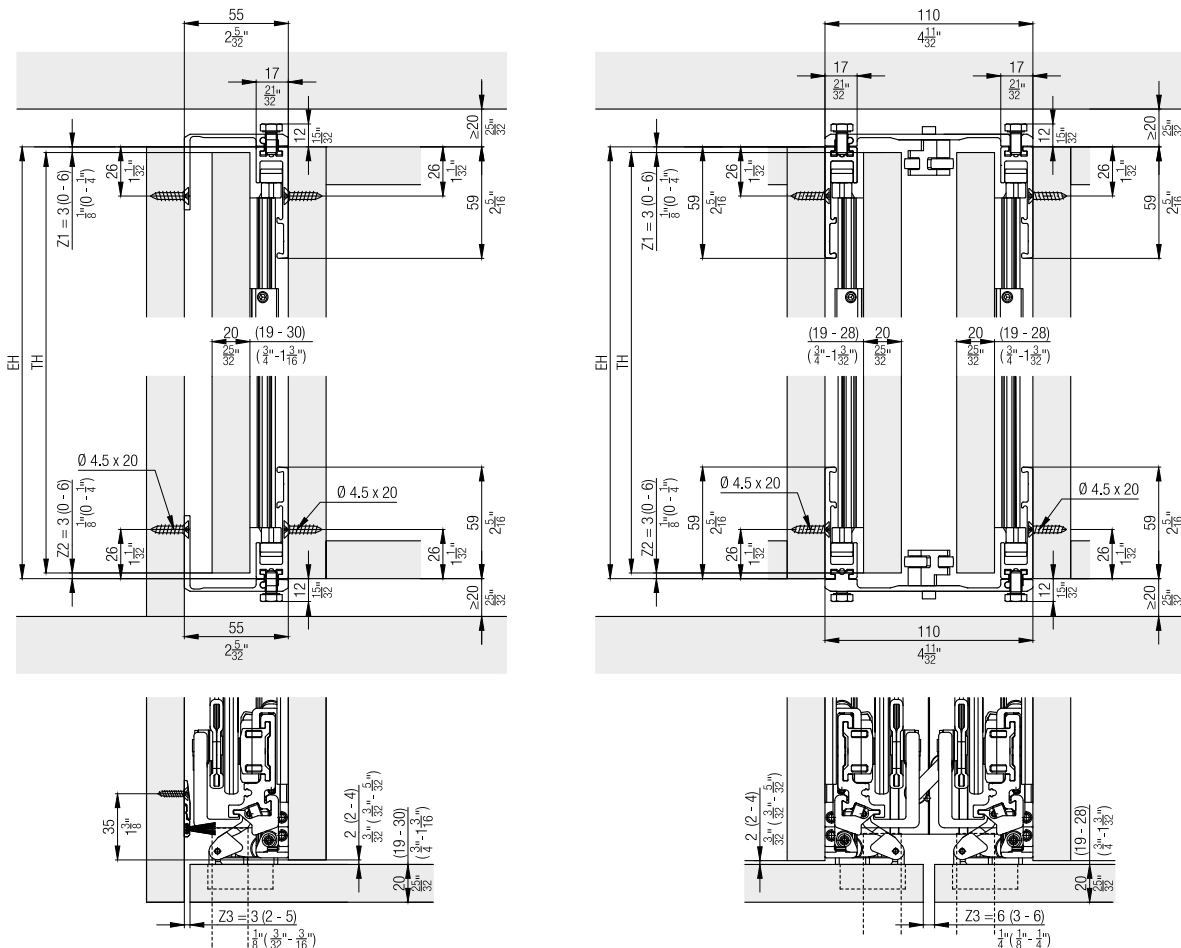
Technical specifications

-  Max. 10–25 kg (22 to 55 lbs.)
-  Max. 1250–1850 mm (4'1 7/32" to 6' 27/32")
-  Max. 300–750 mm (11 13/16" to 2'5 17/32")
-  19–50 mm (3/4" to 1 31/32")

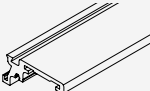








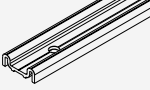




Installation examples

Door striking against the top and bottom cabinet sections




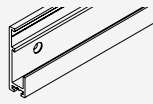
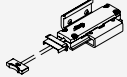



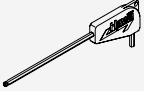
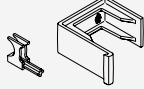


Set for 1 pivot /slide-in door up to 25 kg (55 lbs.)

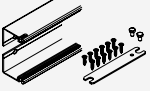
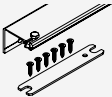
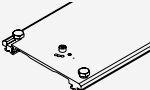
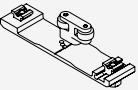
		No.	
Hawa Concepta 25, for 1 door		27648	
		27648	No.
Set consisting of:			
	Upright, 1800 mm (5'10 7/8"), aluminum, anodized	1	22055
	Upright guide, rattle proof, with plastic rollers	2	25656
	Torsion plate	1	27704
	Scissor action complete, 900 mm (2'11 7/16"), steel, galvanized	1	22592
	Front scissor guide, aluminum, anodized	1	25592
	Rear scissor guide, aluminum, anodized	1	25596
	Rear scissor bearing, 55 mm (2 5/32"), steel, galvanized	1	25855
	Concealed hinge with damper, nickel-plated, 3 pieces	1	27654
	Set of screws for concealed hinges, 4x16 mm (5/8"), set of 10 pieces	1	25935
	Spacer profile, 860 mm (2'9 27/32"), pre-drilled, plastic, black	1	22861
	Set of screws for spacer profile, PH 4x16 mm (5/8"), set of 7 pieces	1	25562
	Brush guide, plastic, black, set of 3 pieces	1	25815

Continued table on next column


Table continued from previous column

	Stop cover cap Hawa Concepta, depth adjustable, top left/bottom right	1	27657
	Stop cover cap Hawa Concepta, depth adjustable, top right/bottom left	1	27658
	Cover plates, stainless steel, 1 pair	1	24739
	Bottom guide channel, 728 mm (2'4 21/32"), aluminum, anodized, pre-drilled	2	24533
	Stop damper, with retaining bracket	1	24661
	Door retractor 25/50, with damper, plastic, black	1	25814
	Soft closing system for end position, with cover caps, plastic, black	1	25862
	Screw set, 4,5x20 mm (25/32"), set of 22 pieces	1	22451
	Allen key, with handle, 3 mm (1/8")	1	13164
	Installation aid, plastic, red	1	25816


Cabinet connecting profile

		mm (inch)	No.
	Connector 55 mm (2 5/32"), for one pivot/slide-in door, aluminum, plain anodized, 2 pieces	650 (2' 1 19/32")	25438
	Connector 55 mm (2 5/32"), for one pivot/slide-in door, aluminium, anodized, 1 piece	650 (2' 1 19/32")	23221
		900 (2' 11 7/16")	23222
	Connector 110 mm (4 11/32"), for two pivot/slide-in doors, aluminium, anodized, 1 piece	650 (2' 1 19/32")	23223
		900 (2' 11 7/16")	23224
	Connector 110 mm (4 11/32"), for two pivot/slide-in doors, aluminium, anodized, 1 piece (for installation in front of a fixed base)	26 (1 1/32")	23225

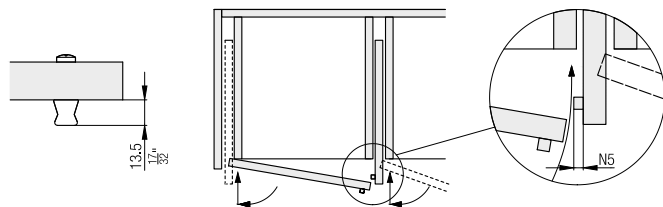
Guides

		No.
	Guide for two inset pivot sliding doors, aluminum	25680

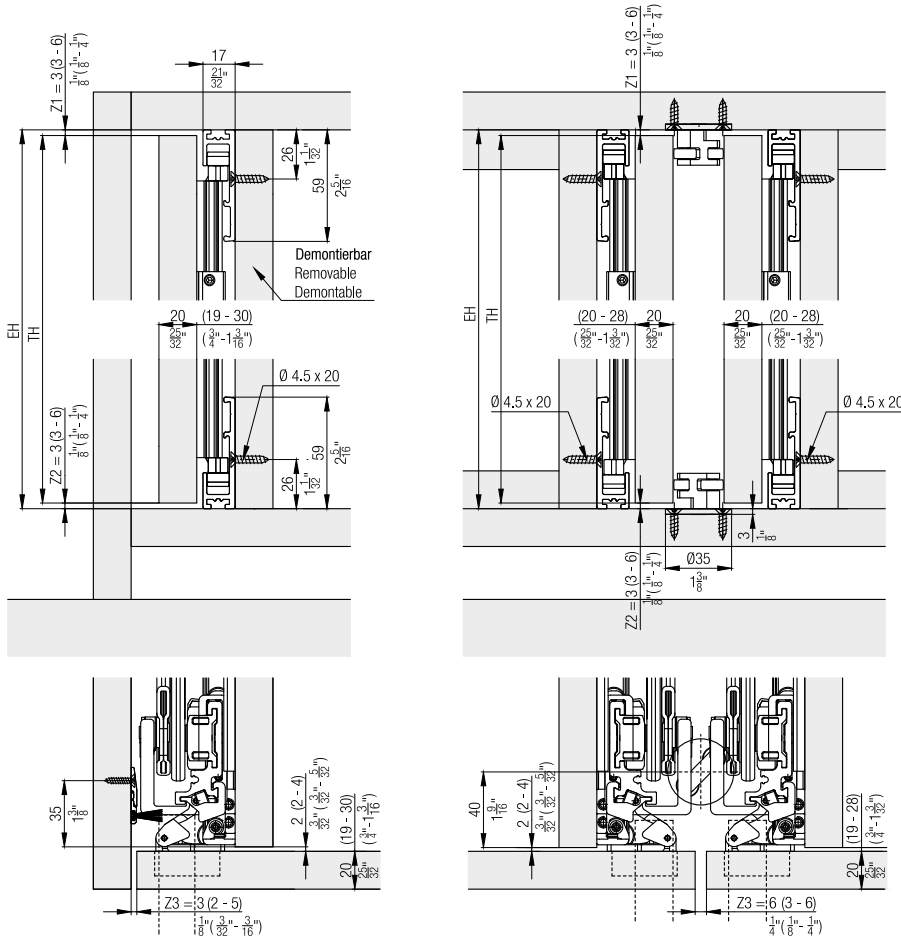
Door handles

		mm (inch)	No.
	Door handle, aluminum, anodized	400 (1' 3 3/4")	22692

Door handle height

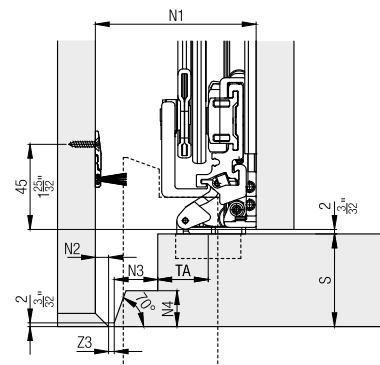
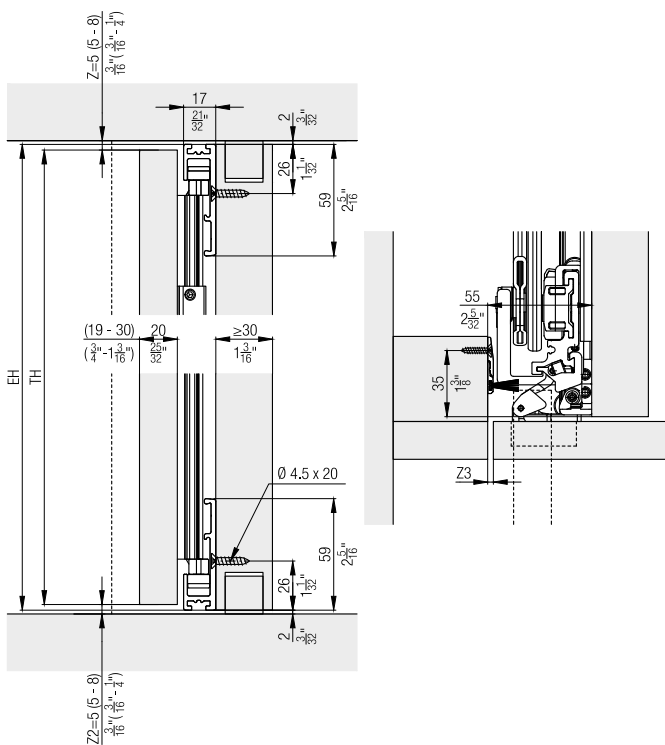


Further installation examples
Inset door



Door in wall niche

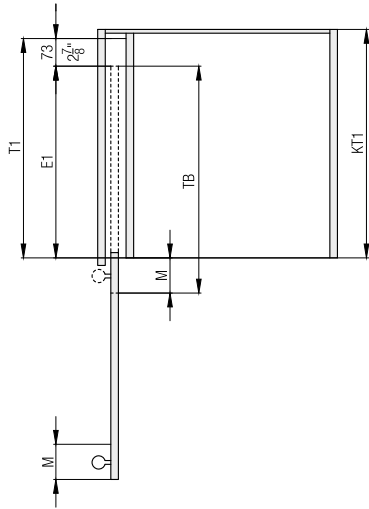
Door thickness 31–50 mm (1 7/32" to 1 31/32")



S	N1	N2	N3	N4
19-30 mm	55 mm	0 mm	0 mm	0 mm
33 mm	58 mm	0 mm	3 mm	3 mm
36 mm	63 mm	2 mm	6 mm	5 mm
39 mm	67 mm	3 mm	9 mm	8 mm
42 mm	70 mm	3 mm	12 mm	11 mm
45 mm	75 mm	5 mm	15 mm	14 mm
48 mm	79 mm	6 mm	18 mm	17 mm
50 mm	83 mm	7 mm	21 mm	19 mm

S	N1	N2	N3	N4
3/4" - 1 3/16"	2 3/16"	0	0	0
1 5/16"	2 9/32"	0	1/8"	1/8"
1 7/16"	2 1/4"	3/32"	1/4"	7/32"
1 17/32"	2 31/32"	1/8"	3/8"	5/16"
1 21/32"	2 3/4"	1/8"	15/32"	7/16"
1 25/32"	2 31/32"	7/32"	19/32"	9/16"
1 29/32"	3 1/8"	1/4"	23/32"	11/16"
1 31/32"	3 9/32"	9/32"	27/32"	3/4"

Fitting depth calculations



$$T1 = TB - M + 73 \text{ mm}$$

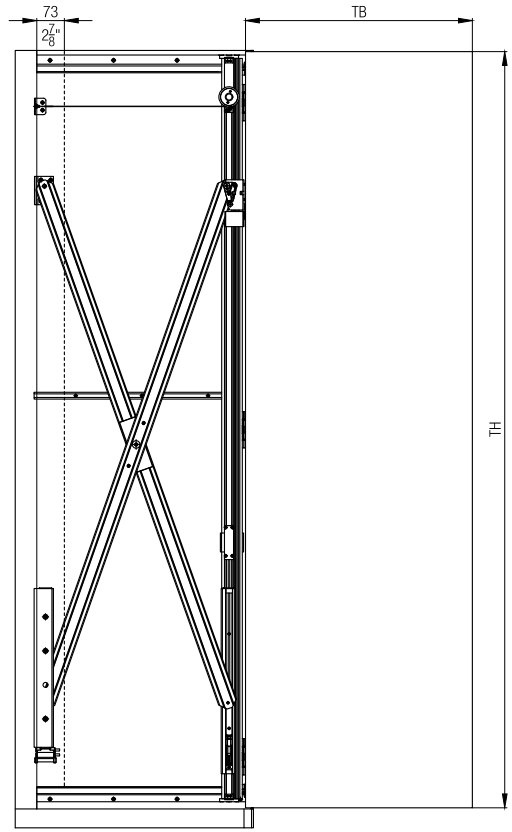
$$E1 = T1 - 73 \text{ mm}$$

$$T1 = TB - M + 2\frac{7}{8}''$$

$$E1 = T1 - 2\frac{7}{8}''$$

	T1	TH	E1
Hawa Concepta 25	≤ 650 mm	1250 - 1850 mm	300 - 577 mm

	T1	TH	E1
Hawa Concepta 25	≤ 2' 1 $\frac{19}{32}$ "	4' 1 $\frac{7}{32}$ " - 6' 0 $\frac{27}{32}$ "	11 $\frac{13}{16}$ " - 1' 10 $\frac{23}{32}$ "



Weight and door size ratio calculations

The maximum weight must be adapted depending on the door size ratio.

TH \ TB	300	350	400	450	500	550	600	650	700	750
1850	25	25	25	25	25	25	25	24	23	22
1800	25	25	25	25	25	25	25	23	22	21
1750	25	25	25	25	25	25	24	22	21	21
1700	25	25	25	25	25	25	24	21	21	20
1650	25	25	25	25	25	25	23	21	20	19
1600	25	25	25	25	25	24	22	20	19	18
1550	25	25	25	25	25	24	21	19	18	18
1500	25	25	25	25	25	23	21	18	18	17
1450	25	25	25	25	24	22	20	18	17	16
1400	25	25	25	25	24	21	19	17	16	15
1350	25	25	25	24	23	21	18	19	16	15
1300	25	25	25	24	22	20	18	15	15	14
1250	25	25	24	23	21	19	17	15	14	13

Door weight in kg | TB = Door width in mm | TH = Door height in mm

Accessories

– Straightening fitting from page 236



Planning/execution

Configure with just a few clicks on www.concepta.hawa.com


Further information about the product can be found on www.hawa.com.

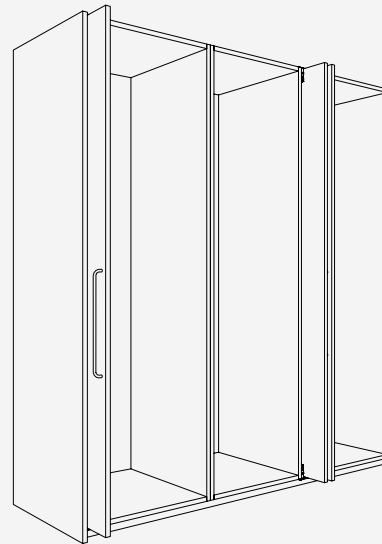
Fitting for pivoting and lateral sliding in of wooden doors up to 30 kg (66 lbs.). Enables multi-functional room design, paired with a flush-fitting design.

Product highlights

-  **Flexibility** Tremendous flexible door dimensions provides a high degree of design freedom
-  **Comfort** Easy, quiet operation thanks to soft closing mechanism and hinges with integrated soft closing mechanism

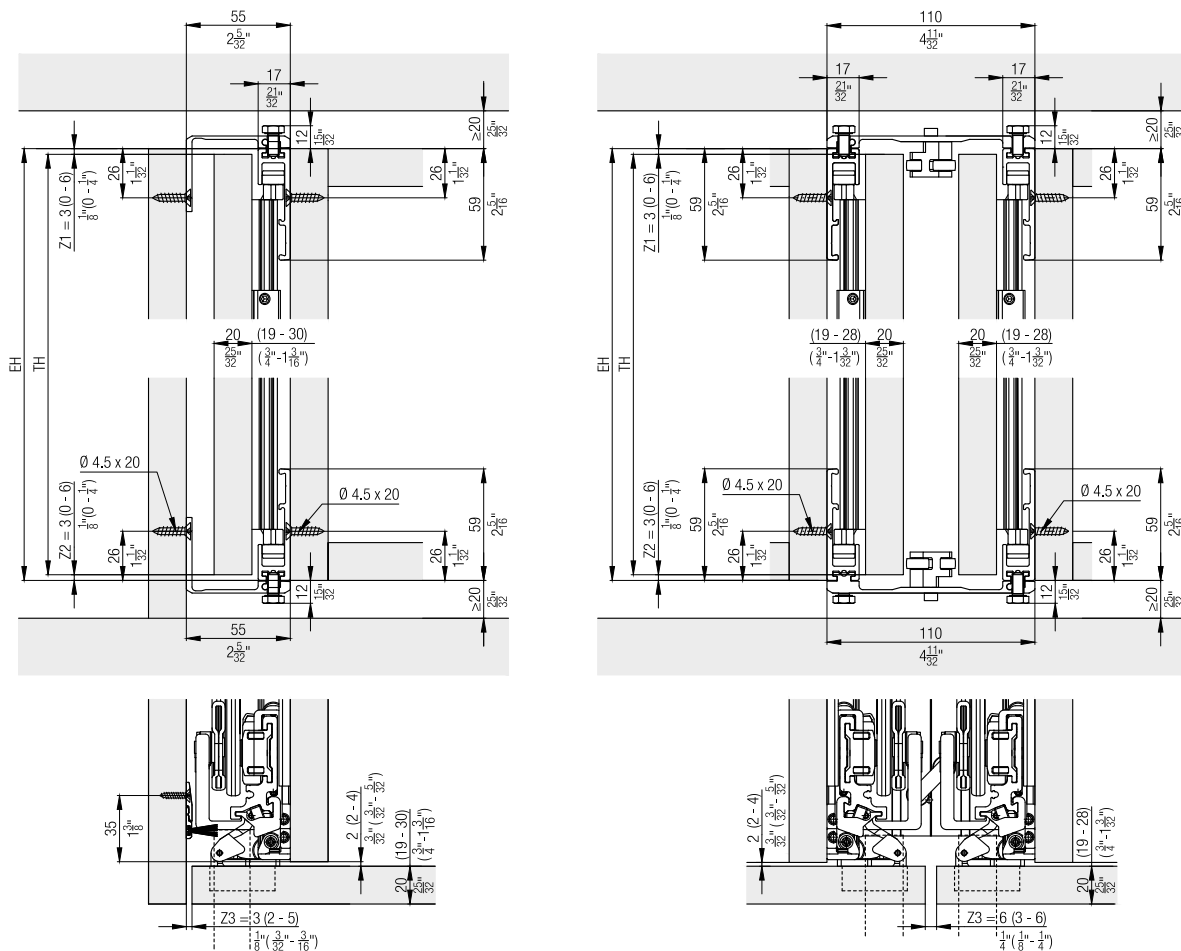
Technical specifications

-  Max. 15-30 kg (33 to 66 lbs.)
-  Max. 1851-2300 mm (6' 7/8" to 7'6 9/16")
-  Max. 300-900 mm (11 13/16" to 2'11 7/16")
-  19-50 mm (3/4" to 1 31/32")

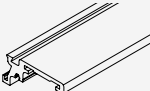








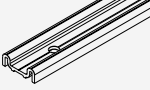




Installation examples

Door striking against the top and bottom cabinet sections




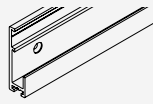
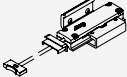
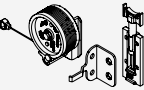


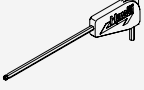
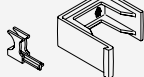


Set for 1 pivot /slide-in door up to 30 kg (66 lbs.)

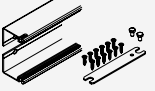
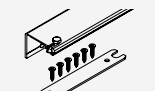

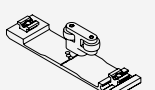
		No.			
Hawa Concepta 30, for 1 door		27649			
		27649	No.		
Set consisting of:					
	Upright, 2300 mm (7'6 9/16"), aluminum, anodized			1	24699
	Upright guide, rattle proof, with plastic rollers			2	25656
	Torsion plate			1	27704
	Scissor action, complete, galvanized steel			1	22593
	Front scissor guide, aluminum, anodized			1	25592
	Rear scissor guide, aluminum, anodized			1	25596
	Rear scissor bearing, 55 mm (2 5/32"), steel, galvanized			1	25855
	Concealed hinge with damper, nickel-plated, 3 pieces			1	27654
	Set of screws for concealed hinges, 4x16 mm (5/8"), set of 10 pieces			1	25935
	Spacer profile, 860 mm (2'9 27/32"), pre-drilled, plastic, black			1	22861
	Set of screws for spacer profile, PH 4x16 mm (5/8"), set of 7 pieces			1	25562
	Brush guide, plastic, black, set of 3 pieces	1	25815		

Continued table on next column


Table continued from previous column

	Stop cover cap Hawa Concepta, depth adjustable, top left/bottom right	1	27657
	Stop cover cap Hawa Concepta, depth adjustable, top right/bottom left	1	27658
	Cover plates, stainless steel, 1 pair	1	24739
	Bottom guide channel, 896 mm (2'11 9/32"), aluminium, anodized, pre-drilled	2	24535
	Stop damper, with retaining bracket	1	24660
	Door retractor 30/40, with damper, plastic, black	1	25813
	Soft closing system for end position, with cover caps, plastic, black	1	25862
	Screw set, 4,5x20 mm (25/32"), set of 22 pieces	1	22451
	Allen key, with handle, 3 mm (1/8")	1	13164
	Installation aid, plastic, red	1	25816


Cabinet connecting profile

		mm (inch)	No.
	Connector 55 mm (2 5/32"), for one pivot/slide-in door, aluminum, plain anodized, 2 pieces	650 (2' 1 19/32")	25438
	Connector 55 mm (2 5/32"), for one pivot/slide-in door, aluminium, anodized, 1 piece	650 (2' 1 19/32")	23221
		900 (2' 11 7/16")	23222
	Connector 110 mm (4 11/32"), for two pivot/slide-in doors, aluminium, anodized, 1 piece	650 (2' 1 19/32")	23223
		900 (2' 11 7/16")	23224
	Connector 110 mm (4 11/32"), for two pivot/slide-in doors, aluminium, anodized, 1 piece (for installation in front of a fixed base)	26 (1 1/32")	23225

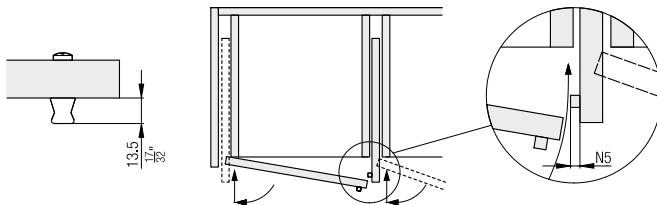
Guides

		No.
	Guide for two inset pivot sliding doors, aluminum	25680

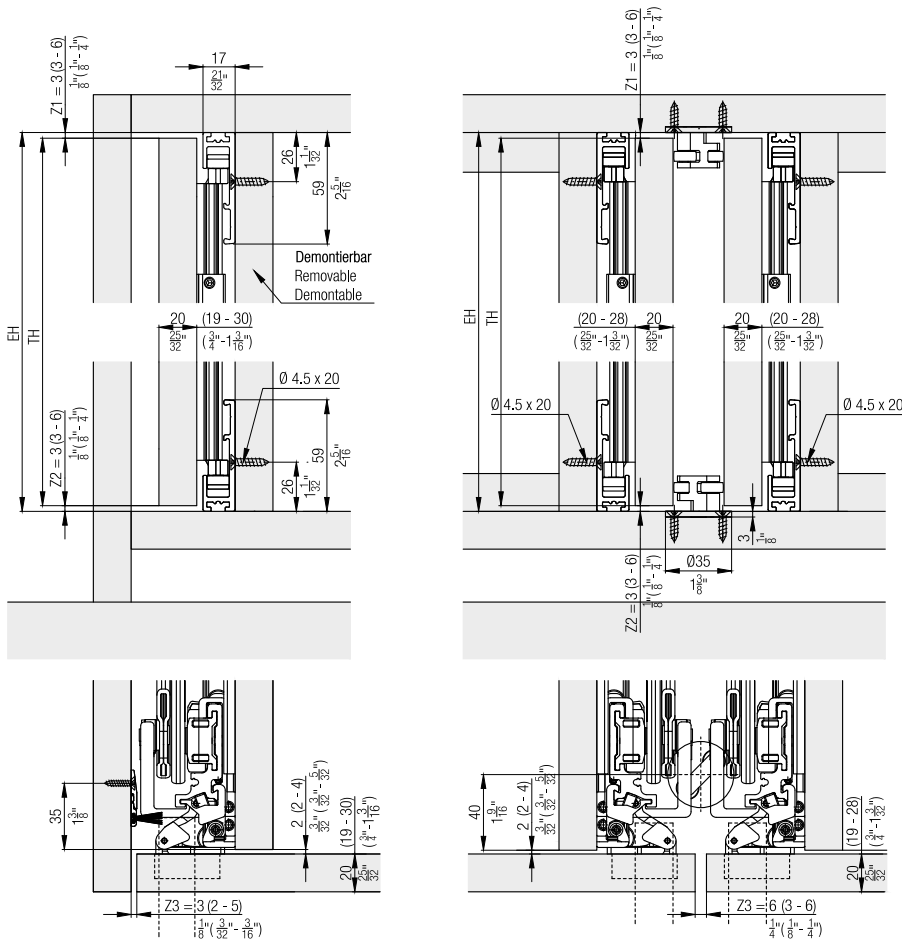
Door handles

		mm (inch)	No.
	Door handle, aluminum, anodized	400 (1' 3 3/4")	22692

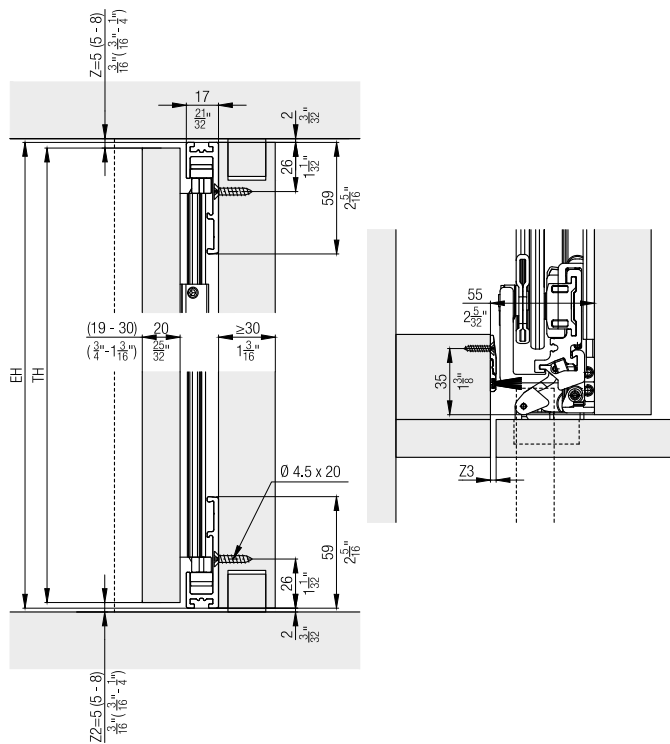
Door handle height



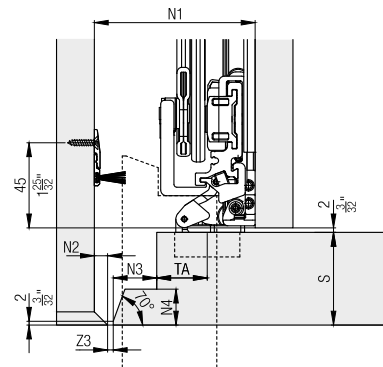
Further installation examples
Inset door



Door in wall niche



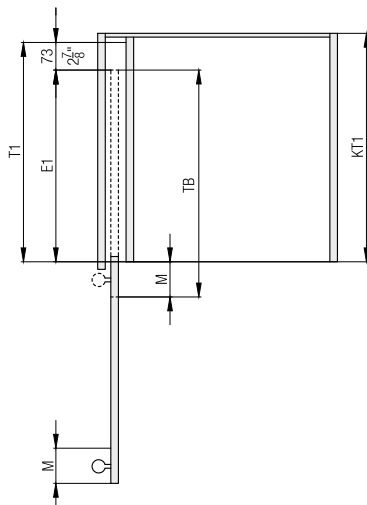
Door thickness 31–50 mm (1 7/32" to 1 31/32")



S	N1	N2	N3	N4
19-30 mm	55 mm	0 mm	0 mm	0 mm
33 mm	58 mm	0 mm	3 mm	3 mm
36 mm	63 mm	2 mm	6 mm	5 mm
39 mm	67 mm	3 mm	9 mm	8 mm
42 mm	70 mm	3 mm	12 mm	11 mm
45 mm	75 mm	5 mm	15 mm	14 mm
48 mm	79 mm	6 mm	18 mm	17 mm
50 mm	83 mm	7 mm	21 mm	19 mm

S	N1	N2	N3	N4
$\frac{3}{4} - \frac{1}{16}$ "	$\frac{2}{16}$ "	0	0	0
$\frac{1}{16}$ "	$\frac{2}{32}$ "	0	$\frac{1}{8}$ "	$\frac{1}{8}$ "
$\frac{7}{16}$ "	$\frac{2}{16}$ "	$\frac{3}{32}$ "	$\frac{1}{4}$ "	$\frac{7}{32}$ "
$\frac{17}{32}$ "	$\frac{2}{32}$ "	$\frac{1}{8}$ "	$\frac{3}{8}$ "	$\frac{5}{16}$ "
$\frac{21}{32}$ "	$\frac{2}{4}$ "	$\frac{1}{8}$ "	$\frac{15}{32}$ "	$\frac{7}{16}$ "
$\frac{25}{32}$ "	$\frac{2}{32}$ "	$\frac{7}{32}$ "	$\frac{19}{32}$ "	$\frac{9}{16}$ "
$\frac{29}{32}$ "	$\frac{1}{8}$ "	$\frac{1}{4}$ "	$\frac{23}{32}$ "	$\frac{11}{16}$ "
$\frac{31}{32}$ "	$\frac{3}{32}$ "	$\frac{9}{32}$ "	$\frac{27}{32}$ "	$\frac{3}{4}$ "

Fitting depth calculations



$$T1 = TB - M + 73 \text{ mm}$$

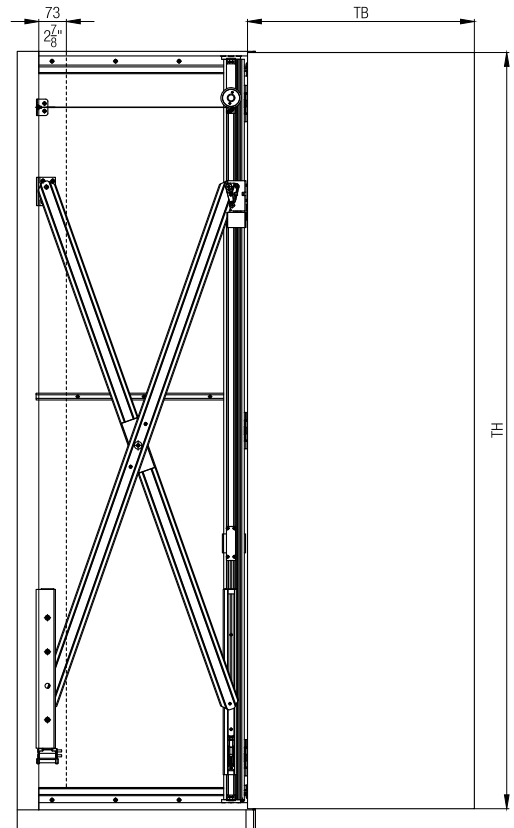
$$E1 = T1 - 73 \text{ mm}$$

$$T1 = TB - M + 2\frac{7}{8}''$$

$$E1 = T1 - 2\frac{7}{8}''$$

	T1	TH	E1
Hawa Concepta 30	≤ 900 mm	1851 - 2300 mm	300 - 827 mm

	T1	TH	E1
Hawa Concepta 30	≤ 2' 11 $\frac{7}{16}$ "	6' 0 $\frac{7}{8}$ " - 7' 6 $\frac{9}{16}$ "	11 $\frac{13}{16}$ " - 2' 8 $\frac{9}{16}$ "



Weight and door size ratio calculations

The maximum weight must be adapted depending on the door size ratio.

TH \ TB	300	350	400	450	500	550	600	650	700	750	800	850	900
2300	30	30	30	30	30	30	30	30	30	30	29	27	26
2250	30	30	30	30	30	30	30	30	30	30	28	27	25
2200	30	30	30	30	30	30	30	30	30	29	27	26	24
2150	30	30	30	30	30	30	30	30	30	29	27	25	24
2100	30	30	30	30	30	30	30	30	30	28	26	25	23
2050	30	30	30	30	30	30	30	30	29	27	25	24	23
2000	30	30	30	30	30	30	30	30	29	26	25	23	22
1950	30	30	30	30	30	30	30	29	27	26	24	23	21
1900	30	30	30	30	30	30	30	29	27	25	23	22	21
1851	30	30	30	30	30	30	30	28	26	24	23	21	20

Door weight in kg | TB = Door width in mm | TH = Door height in mm

Accessories

– Straightening fitting from page 236



Planning/execution

Configure with just a few clicks on www.concepta.hawa.com





Further information about the product can be found on www.hawa.com.

Fitting for pivoting and lateral sliding in of wooden doors up to 40 kg (88 lbs.). Enables multi-functional room design, paired with a flush-fitting design.

Product highlights

-  **Flexibility** Tremendous flexible door dimensions provides a high degree of design freedom
-  **Comfort** Easy, quiet operation thanks to soft closing mechanism and hinges with integrated soft closing mechanism

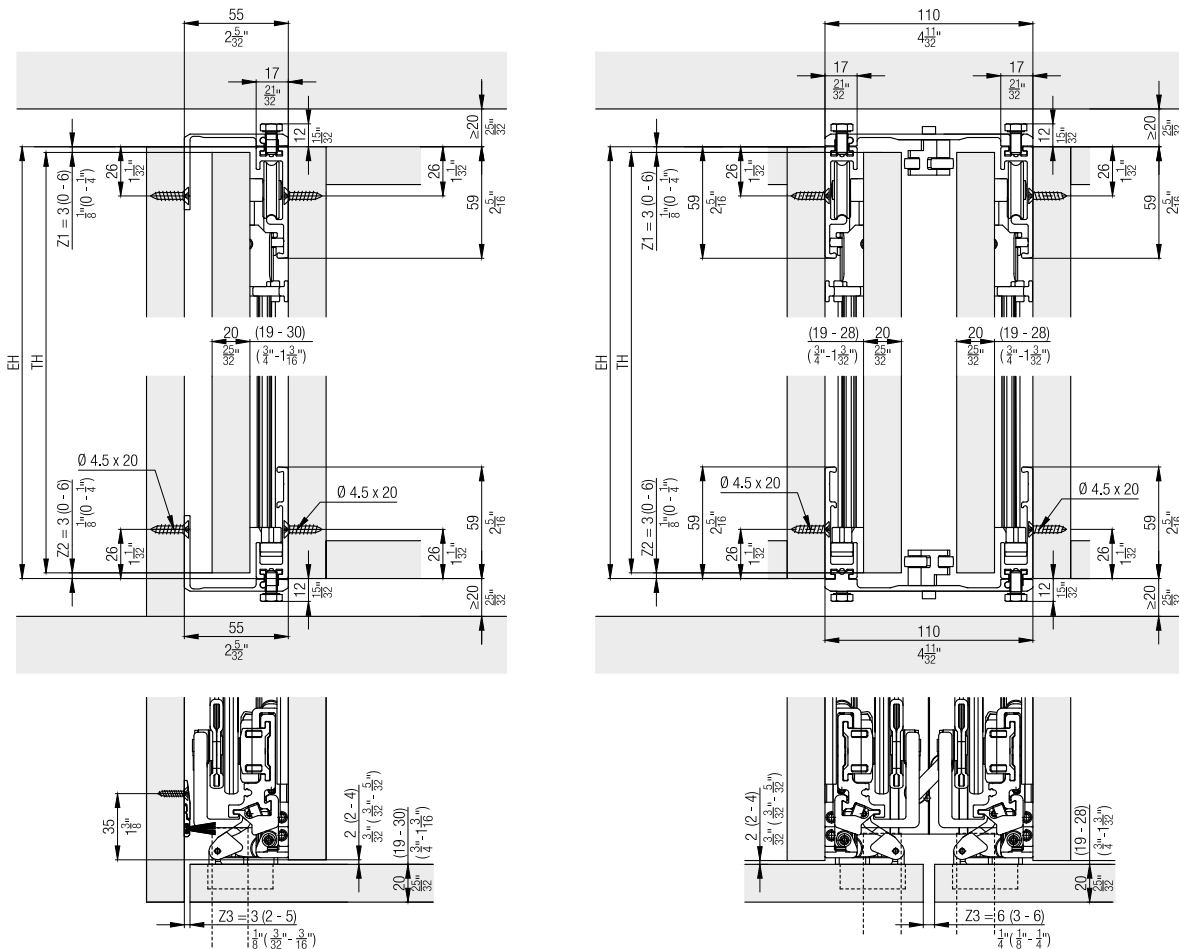
Technical specifications

-  Max. 20–40 kg (44 to 88 lbs.)
-  Max. 1851–2500 mm (6' 7/8" to 8'2 7/16")
-  Max. 300–900 mm (11 13/16" to 2'11 7/16")
-  19–50 mm (3/4" to 1 31/32")



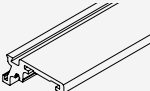







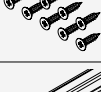
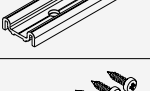
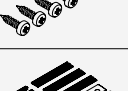
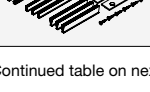
Installation examples

Door striking against the top and bottom cabinet sections



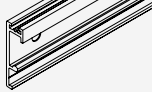




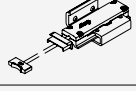
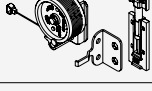
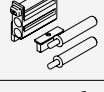
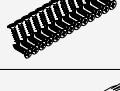


Set for 1 pivot /slide-in door up to 40 kg (88 lbs.)

Hawa Concepta 40, for 1 door	No. 27650
------------------------------	--------------

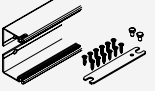
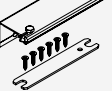

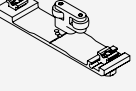
Set consisting of:		27650	No.
	Upright, 2500 mm (8'2 7/16"), aluminum, anodized	1	22056
	Two-wheeled running gear, height-adjustable, with torsion plate, zinc-plated matt	1	24955
	Upright guide, rattle proof, with plastic rollers	1	25656
	Scissor action complete, 1500 mm (4'11 1/16"), steel, galvanized	1	22594
	Front scissor guide, aluminum, anodized	1	25592
	Rear scissor guide, aluminum, anodized	1	25596
	Rear scissor bearing, 55 mm (2 5/32"), steel, galvanized	1	25855
	Concealed hinge with damper, nickel-plated, 4 pieces	1	27655
	Set of screws for concealed hinges, 4x16 mm (5/8"), set of 10 pieces	1	25935
	Spacer profile, 860 mm (2'9 27/32"), pre-drilled, plastic, black	1	22861
	Set of screws for spacer profile, PH 4x16 mm (5/8"), set of 7 pieces	1	25562
	Brush guide, plastic, black, set of 3 pieces	1	25815

Continued table on next column


Table continued from previous column

	Running track, 896 mm (2'11 9/32"), aluminium, anodized, pre-drilled	1	24528
	Bottom guide channel, 896 mm (2'11 9/32"), aluminium, anodized, pre-drilled	1	24535
	Stop cover cap Hawa Concepta, depth adjustable, top left/bottom right	1	27657
	Stop cover cap Hawa Concepta, depth adjustable, top right/bottom left	1	27658
	Cover plates, stainless steel, 1 pair	1	24739
	Stop damper, with retaining bracket	1	24660
	Door retractor 30/40, with damper, plastic, black	1	25813
	Soft closing system for end position, with cover caps, plastic, black	1	25862
	Screw set, 4,5x20 mm (25/32"), set of 22 pieces	1	22451
	Allen key, with handle, 3 mm (1/8")	1	13164
	Installation aid, plastic, red	1	25816


Cabinet connecting profile

		mm (inch)	No.
	Connector 55 mm (2 5/32"), for one pivot/slide-in door, aluminum, plain anodized, 2 pieces	650 (2' 1 19/32")	25438
	Connector 55 mm (2 5/32"), for one pivot/slide-in door, aluminium, anodized, 1 piece	650 (2' 1 19/32")	23221
		900 (2' 11 7/16")	23222
	Connector 110 mm (4 11/32"), for two pivot/slide-in doors, aluminium, anodized, 1 piece	650 (2' 1 19/32")	23223
		900 (2' 11 7/16")	23224
	Connector 110 mm (4 11/32"), for two pivot/slide-in doors, aluminium, anodized, 1 piece (for installation in front of a fixed base)	26 (1 1/32")	23225

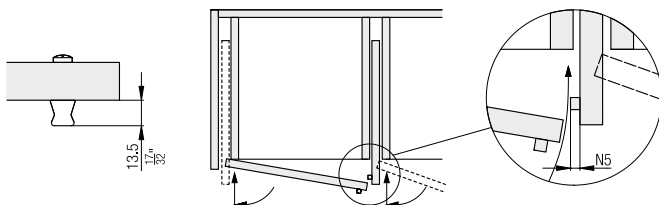
Guides

		No.
	Guide for two inset pivot sliding doors, aluminum	25680

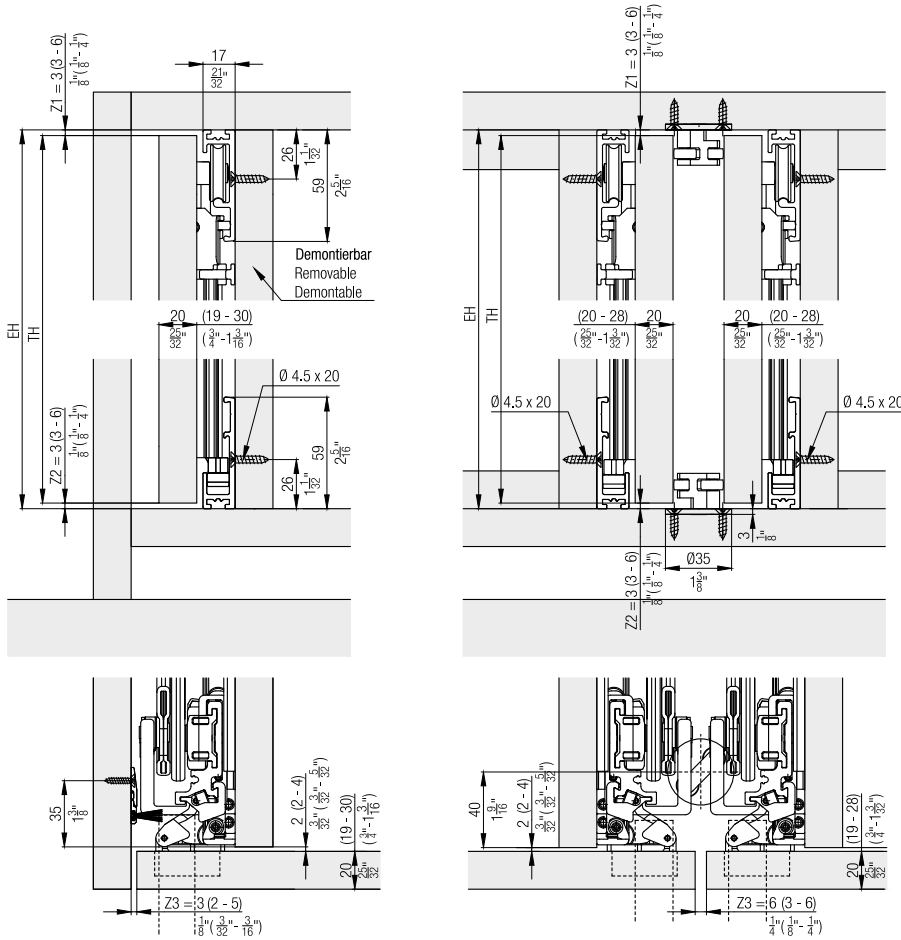
Door handles

		mm (inch)	No.
	Door handle, aluminum, anodized	400 (1' 3 3/4")	22692

Door handle height

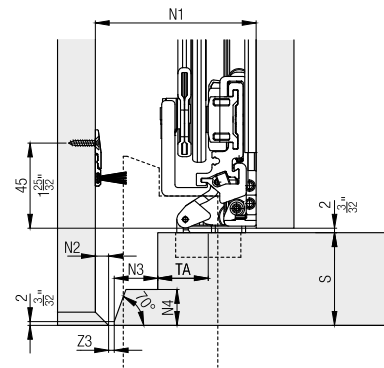
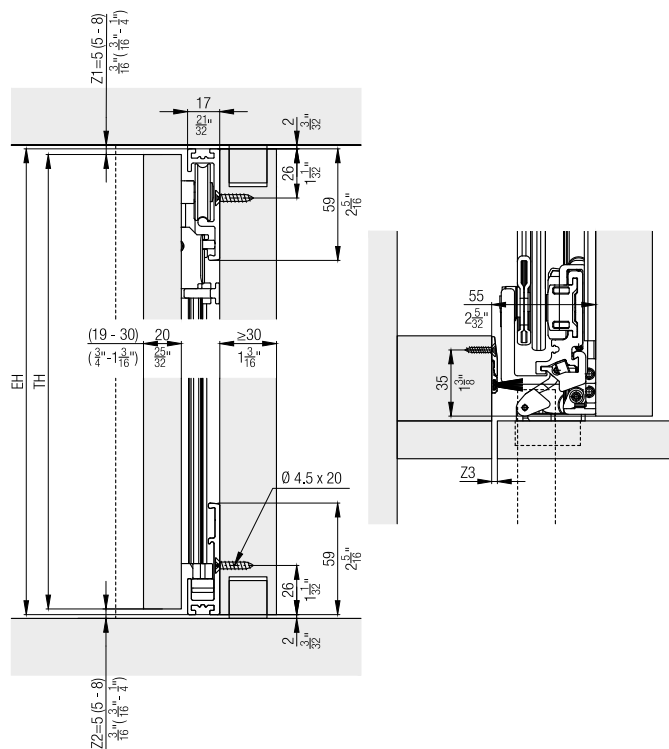


Further installation examples
Inset door



Door in wall niche

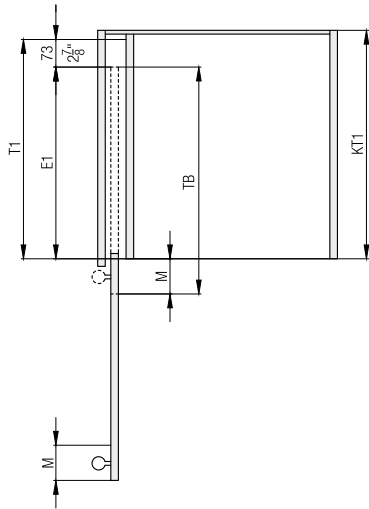
Door thickness 31-50 mm (1 7/32" to 1 31/32")



S	N1	N2	N3	N4
19-30 mm	55 mm	0 mm	0 mm	0 mm
33 mm	58 mm	0 mm	3 mm	3 mm
36 mm	63 mm	2 mm	6 mm	5 mm
39 mm	67 mm	3 mm	9 mm	8 mm
42 mm	70 mm	3 mm	12 mm	11 mm
45 mm	75 mm	5 mm	15 mm	14 mm
48 mm	79 mm	6 mm	18 mm	17 mm
50 mm	83 mm	7 mm	21 mm	19 mm

S	N1	N2	N3	N4
$\frac{3}{4}$ " - $1\frac{3}{16}$ "	$2\frac{3}{16}$ "	0	0	0
$1\frac{5}{16}$ "	$2\frac{9}{32}$ "	0	$\frac{1}{8}$ "	$\frac{1}{8}$ "
$1\frac{7}{16}$ "	$2\frac{1}{2}$ "	$\frac{3}{32}$ "	$\frac{1}{4}$ "	$\frac{7}{32}$ "
$1\frac{17}{32}$ "	$2\frac{21}{32}$ "	$\frac{1}{8}$ "	$\frac{3}{8}$ "	$\frac{5}{16}$ "
$1\frac{21}{32}$ "	$2\frac{4}{8}$ "	$\frac{1}{8}$ "	$\frac{15}{32}$ "	$\frac{7}{16}$ "
$1\frac{25}{32}$ "	$2\frac{31}{32}$ "	$\frac{7}{32}$ "	$\frac{19}{32}$ "	$\frac{9}{16}$ "
$1\frac{29}{32}$ "	$3\frac{1}{8}$ "	$\frac{1}{4}$ "	$\frac{23}{32}$ "	$\frac{11}{16}$ "
$1\frac{31}{32}$ "	$3\frac{9}{32}$ "	$\frac{9}{32}$ "	$\frac{27}{32}$ "	$\frac{3}{4}$ "

Fitting depth calculations



$$T1 = TB - M + 73 \text{ mm}$$

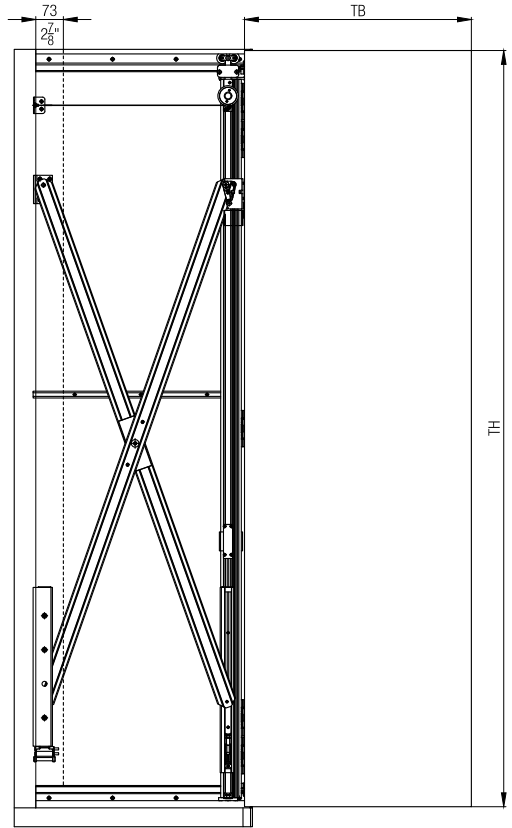
$$E1 = T1 - 73 \text{ mm}$$

$$T1 = TB - M + 2\frac{7}{8}''$$

$$E1 = T1 - 2\frac{7}{8}''$$

	T1	TH	E1
Hawa Concepta 40	≤ 900 mm	1851 - 2500 mm	300 - 827 mm

	T1	TH	E1
Hawa Concepta 40	≤ 2' 11 $\frac{7}{16}$ "	6' 0 $\frac{6}{8}$ " - 8' 2 $\frac{7}{16}$ "	11 $\frac{13}{16}$ " - 2' 8 $\frac{9}{16}$ "



Weight and door size ratio calculations

The maximum weight must be adapted depending on the door size ratio.

TH \ TB	300	350	400	450	500	550	600	650	700	750	800	850	900
2500	40	40	40	40	40	40	40	40	40	37	34	32	31
2450	40	40	40	40	40	40	40	40	39	36	34	32	30
2400	40	40	40	40	40	40	40	40	38	35	33	31	29
2350	40	40	40	40	40	40	40	40	37	34	32	30	29
2300	40	40	40	40	40	40	40	39	36	33	31	30	28
2250	40	40	40	40	40	40	40	38	35	33	31	29	27
2200	40	40	40	40	40	40	40	37	34	32	30	28	27
2150	40	40	40	40	40	40	39	36	33	31	29	27	26
2100	40	40	40	40	40	40	38	35	32	31	28	27	25
2050	40	40	40	40	40	40	37	34	31	30	28	26	24
2000	40	40	40	40	40	39	36	33	31	29	27	25	24
1950	40	40	40	40	40	38	35	32	30	28	26	24	23
1900	40	40	40	40	40	37	34	31	29	27	25	24	22
1851	40	40	40	40	39	36	33	30	28	26	24	23	22

Door weight in kg | TB = Door width in mm | TH = Door height in mm

Accessories

– Straightening fitting from page 236



Planning/execution

Configure with just a few clicks on www.concepta.hawa.com





Further information about the product can be found on www.hawa.com.

Fitting for pivoting and lateral sliding in of wooden doors up to 50 kg (110 lbs.). Enables multi-functional room design, paired with a flush-fitting design.

Product highlights

-  **Flexibility** Tremendous flexible door dimensions provides a high degree of design freedom
-  **Comfort** Easy, quiet operation thanks to soft closing mechanism and hinges with integrated soft closing mechanism

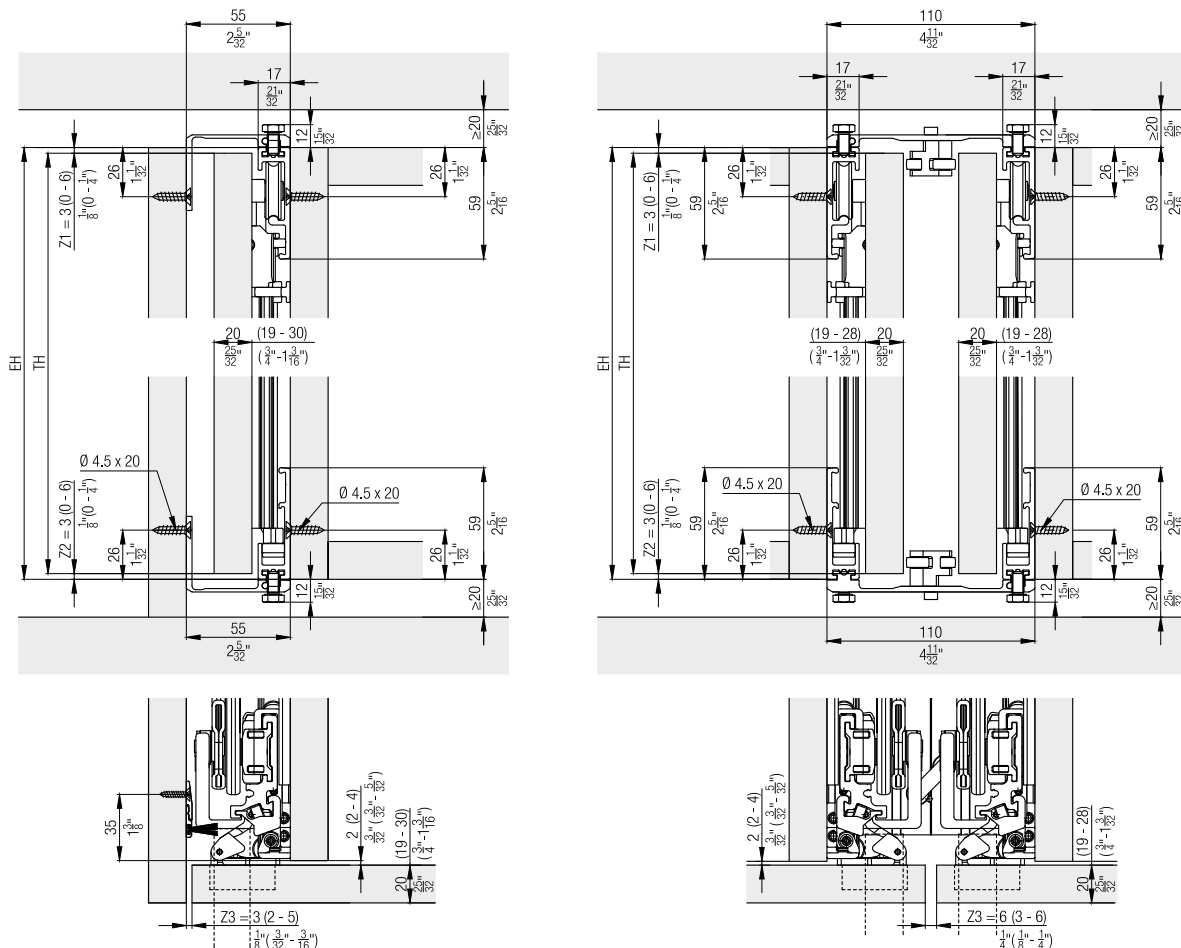
Technical specifications

-  Max. 25--50 kg (55 to 110 lbs.)
-  Max. 2301-2850 mm (7'6 19/32" to 9'4 7/32")
-  Max. 300-900 mm (11 13/16" to 2'11 7/16")
-  19-50 mm (3/4" to 1 31/32")

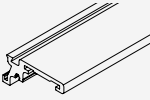








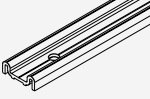

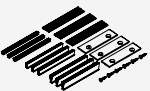


Installation examples

Door striking against the top and bottom cabinet sections



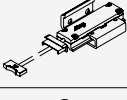






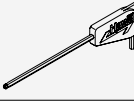
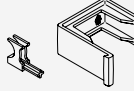


Set for 1 pivot /slide-in door up to 50 kg (110 lbs.)

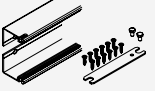
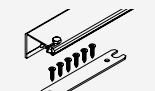

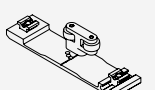
Hawa Concepta 50, for 1 door		No.	
		27651	
Set consisting of:		27651	No.
	Upright, 2760 mm (9' 21/32"), aluminium, anodized	1	22057
	Two-wheeled running gear, height-adjustable, with torsion plate, zinc-plated matt	1	24955
	Upright guide, rattle proof, with plastic rollers	1	25656
	Scissor action complete, 1500 mm (4'11 1/16"), steel, galvanized	1	22594
	Front scissor guide, aluminum, anodized	1	25592
	Rear scissor guide, aluminum, anodized	1	25596
	Rear scissor bearing, 55 mm (2 5/32"), steel, galvanized	1	25855
	Concealed hinge with damper, nickel-plated, 5 pieces	1	27656
	Set of screws for concealed hinges, 4x16 mm (5/8"), set of 10 pieces	1	25935
	Spacer profile, 860 mm (2'9 27/32"), pre-drilled, plastic, black	1	22861
	Set of screws for spacer profile, PH 4x16 mm (5/8"), set of 7 pieces	1	25562
	Brush guide, plastic, black, set of 3 pieces	1	25815

Continued table on next column

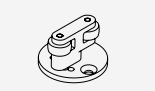
Table continued from previous column

	Running track, 896 mm (2'11 9/32"), aluminium, anodized, pre-drilled	1	24528
	Bottom guide channel, 896 mm (2'11 9/32"), aluminium, anodized, pre-drilled	1	24535
	Stop damper, with retaining bracket	1	24660
	Door retractor 25/50, with damper, plastic, black	1	25814
	Stop cover cap Hawa Concepta, depth adjustable, top left/bottom right	1	27657
	Stop cover cap Hawa Concepta, depth adjustable, top right/bottom left	1	27658
	Cover plates, stainless steel, 1 pair	1	24739
	Soft closing system for end position, with cover caps, plastic, black	1	25862
	Screw set, 4,5x20 mm (25/32"), set of 22 pieces	1	22451
	Allen key, with handle, 3 mm (1/8")	1	13164
	Installation aid, plastic, red	1	25816


Cabinet connecting profile

		mm (inch)	No.
	Connector 55 mm (2 5/32"), for one pivot/slide-in door, aluminum, plain anodized, 2 pieces	650 (2' 1 19/32")	25438
	Connector 55 mm (2 5/32"), for one pivot/slide-in door, aluminium, anodized, 1 piece	650 (2' 1 19/32")	23221
		900 (2' 11 7/16")	23222
	Connector 110 mm (4 11/32"), for two pivot/slide-in doors, aluminium, anodized, 1 piece	650 (2' 1 19/32")	23223
		900 (2' 11 7/16")	23224
	Connector 110 mm (4 11/32"), for two pivot/slide-in doors, aluminium, anodized, 1 piece (for installation in front of a fixed base)	26 (1 1/32")	23225

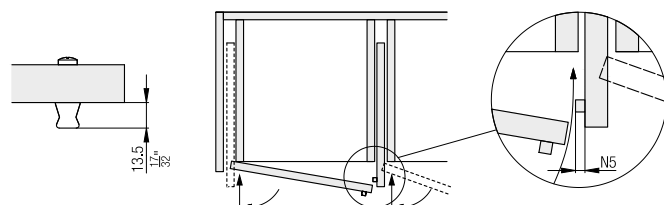
Guides

		No.
	Guide for two inset pivot sliding doors, aluminum	25680

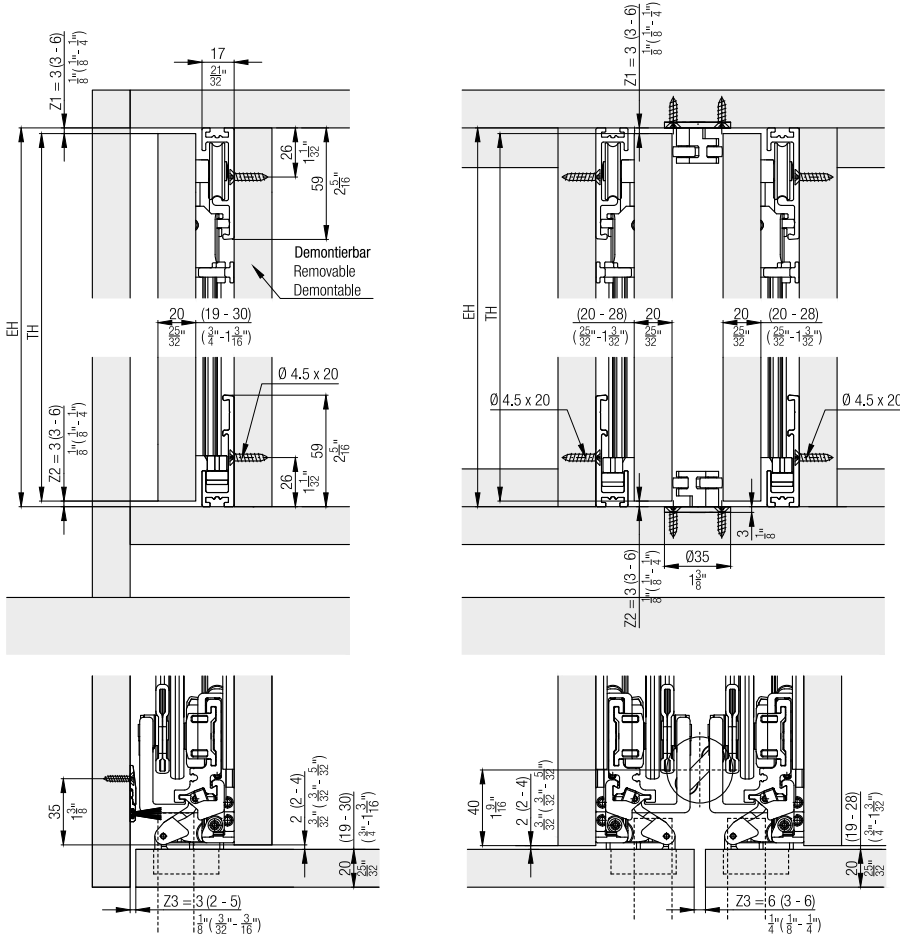
Door handles

		mm (inch)	No.
	Door handle, aluminum, anodized	400 (1' 3 3/4")	22692

Door handle height

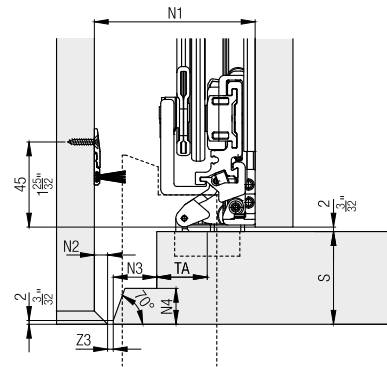
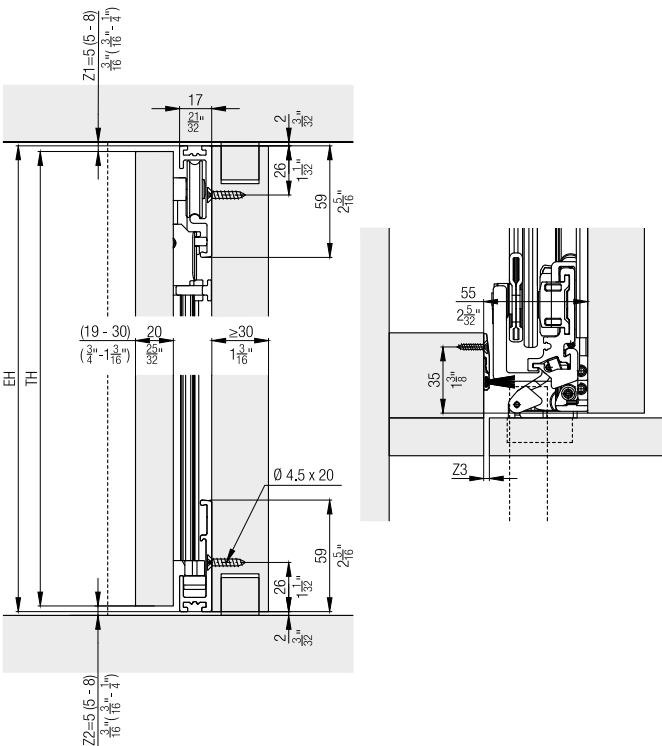


Further installation examples
Inset door



Door in wall niche

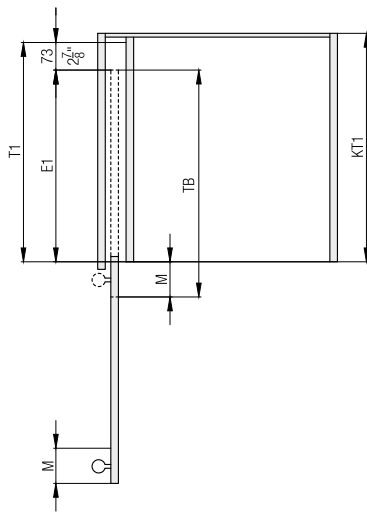
Door thickness 31–50 mm (1 7/32" to 1 31/32")



S	N1	N2	N3	N4
19-30 mm	55 mm	0 mm	0 mm	0 mm
33 mm	58 mm	0 mm	3 mm	3 mm
36 mm	63 mm	2 mm	6 mm	5 mm
39 mm	67 mm	3 mm	9 mm	8 mm
42 mm	70 mm	3 mm	12 mm	11 mm
45 mm	75 mm	5 mm	15 mm	14 mm
48 mm	79 mm	6 mm	18 mm	17 mm
50 mm	83 mm	7 mm	21 mm	19 mm

S	N1	N2	N3	N4
$\frac{3}{4}$ " - $1\frac{3}{16}$ "	$2\frac{3}{16}$ "	0	0	0
$1\frac{5}{16}$ "	$2\frac{9}{32}$ "	0	$\frac{1}{8}$ "	$\frac{1}{8}$ "
$1\frac{7}{16}$ "	$2\frac{1}{32}$ "	$3\frac{1}{32}$ "	$\frac{1}{4}$ "	$7\frac{32}{32}$ "
$1\frac{17}{32}$ "	$2\frac{21}{32}$ "	$1\frac{1}{8}$ "	$3\frac{3}{8}$ "	$5\frac{1}{16}$ "
$1\frac{21}{32}$ "	$2\frac{3}{4}$ "	$1\frac{1}{8}$ "	$15\frac{15}{32}$ "	$7\frac{1}{16}$ "
$1\frac{25}{32}$ "	$2\frac{31}{32}$ "	$7\frac{1}{32}$ "	$19\frac{19}{32}$ "	$9\frac{1}{16}$ "
$1\frac{29}{32}$ "	$3\frac{1}{8}$ "	$1\frac{1}{4}$ "	$23\frac{23}{32}$ "	$11\frac{1}{16}$ "
$1\frac{31}{32}$ "	$3\frac{9}{32}$ "	$1\frac{3}{8}$ "	$27\frac{27}{32}$ "	$13\frac{3}{4}$ "

Fitting depth calculations

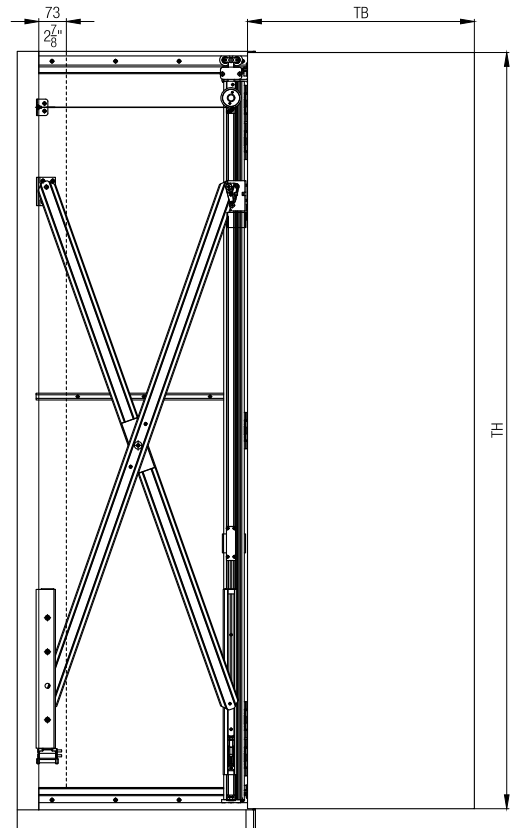


$$T1 = TB - M + 73 \text{ mm}$$

$$E1 = T1 - 73 \text{ mm}$$

$$T1 = TB - M + 2\frac{7}{8}''$$

$$E1 = T1 - 2\frac{7}{8}''$$



	T1	TH	E1
Hawa Concepta 40	≤ 900 mm	1851 - 2500 mm	300 - 827 mm

	T1	TH	E1
Hawa Concepta 40	≤ 2' 11 $\frac{7}{16}$ "	6' 0 $\frac{1}{8}$ " - 8' 2 $\frac{7}{16}$ "	11 $\frac{13}{16}$ " - 2' 8 $\frac{9}{16}$ "

	T1	TH	E1
Hawa Concepta 50	≤ 900 mm	2301 - 2850 mm	300 - 827 mm

	T1	TH	E1
Hawa Concepta 50	≤ 2' 11 $\frac{7}{16}$ "	7' 6 $\frac{19}{32}$ " - 9' 4 $\frac{7}{32}$ "	11 $\frac{13}{16}$ " - 2' 8 $\frac{9}{16}$ "

Weight and door size ratio calculations

The maximum weight must be adapted depending on the door size ratio.

TH \ TB	300	350	400	450	500	550	600	650	700	750	800	850	900
2850	50	50	50	50	50	50	50	50	50	50	50	50	50
2800	50	50	50	50	50	50	50	50	50	50	50	50	50
2750	50	50	50	50	50	50	50	50	50	50	50	50	50
2700	50	50	50	50	50	50	50	50	50	50	50	50	49
2650	50	50	50	50	50	50	50	50	50	50	50	50	48
2600	50	50	50	50	50	50	50	50	50	50	50	49	48
2550	50	50	50	50	50	50	50	50	50	50	50	48	47
2500	50	50	50	50	50	50	50	50	50	50	49	48	46
2450	50	50	50	50	50	50	50	50	50	49	48	47	45
2400	50	50	50	50	50	50	50	50	50	48	48	46	45
2350	50	50	50	50	50	50	50	50	49	48	47	45	44
2301	50	50	50	50	50	50	50	49	48	47	46	45	43

Door weight in kg | TB = Door width in mm | TH = Door height in mm

Accessories

- Straightening fitting from page 236

Planning/execution

Configure with just a few clicks on www.concepta.hawa.com

Further information about the product can be found on www.hawa.com.

Hawa Folding Concepta for wooden pivot and folding/sliding doors

Folding flush-fitting furniture fronts and making them disappear





Make entire cabinet fronts up to 2800 mm in width disappear flush with the outer face with a single manual operation: not a problem with the Hawa Folding Concepta. Two doors can be folded and slid in at the side with this well thought-out fitting system. The slide-in loss is a mere 73 mm using this system, the niche width is just 110 mm and you even gain space in the room, since the doors are stored away flush in the furniture cabinet or in the wall pocket when the front panel is opened. And the high-quality scissor technology of Hawa Sliding Solutions guarantees that the doors move smoothly and quietly without jamming. Easy on the eye: uniform gap pattern in the closed condition – also in combination with Hawa Concepta. And a view of the elegant, black or plain anodized aluminum profiles in open furniture.







Area of application

Variable, multi-functional use of rooms, such as for home offices which disappear behind doors, cabinet fronts which conceal a kitchen, or utility rooms or store rooms which are designed as walk-in cabinets.

System advantages

-  **Flexibility** **Easy adaptation** for wide range of door dimensions
Can be combined with Hawa Concepta to create two, three and four-leaf front panels without separating walls
-  **Productivity** **Efficient installation**, because all components are screwed on
-  **Comfort** **No obstruction** by protruding doors
Entire cabinet fronts can be folded and slid in with a single manual operation
-  **Aesthetics** **Elegant flush-fitting, floor-to-ceiling and walk-in** construction versions possible, including black anodized

Technical specifications

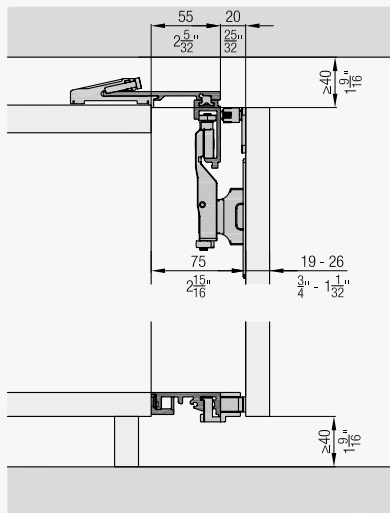
-  max. 25 kg
(50 kg per pair of doors)
-  1250–2600 mm
-  300–700 mm
-  19–26 mm

Good to know (accessories)

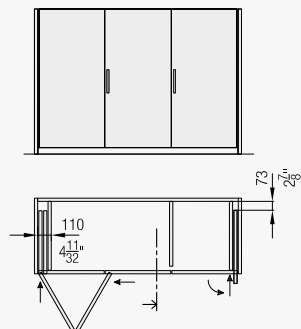
- Straightening fitting for doors
- Reinforcement profile for stability
- Door handle required

Installation examples

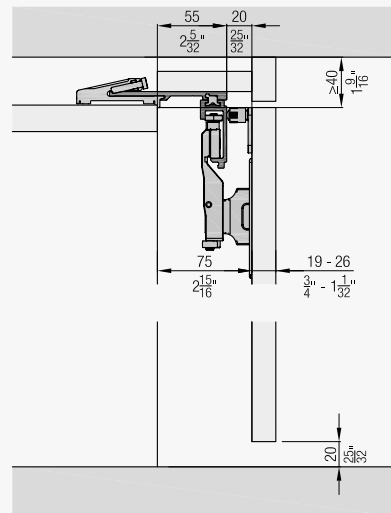
Hawa Folding Concepta 25



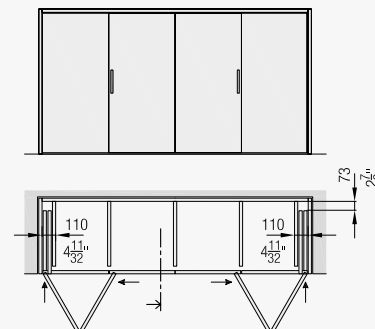
Front-hung cabinet fronts in combination with Hawa Concepta



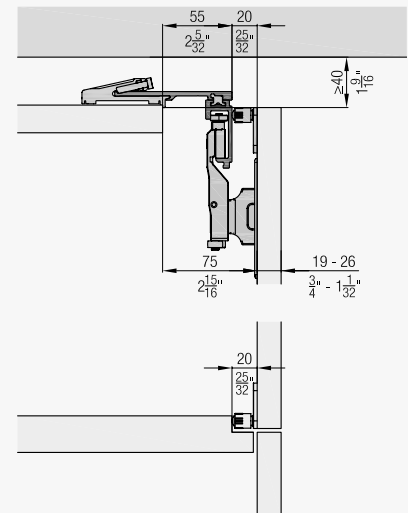
Hawa Folding Concepta 25



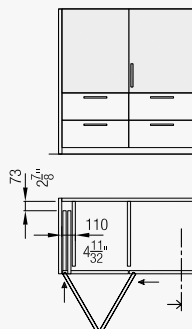
Niche cover without furniture tops



Hawa Folding Concepta 25



Half-height version from worktop



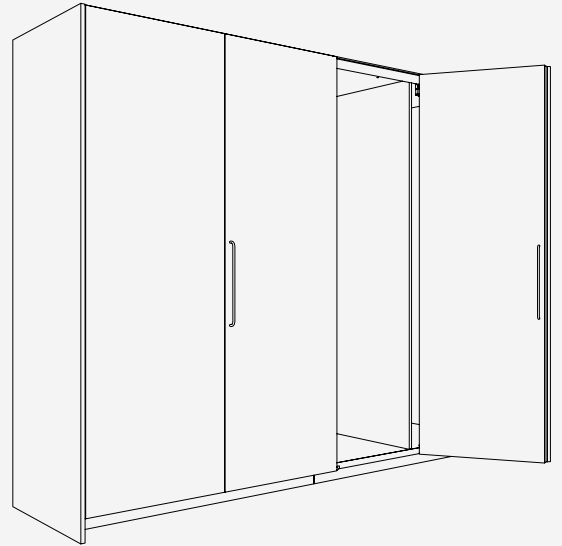
Fitting for pivoting, folding, and lateral sliding in of wooden doors up to 25 kg per door. Enables multi-functional room design, paired with a flush-fitting design.

Product highlights

- Comfort** The entire furniture front can be folded and slid in easily with one hand
- Aesthetics** Supports trends in modern interior design towards flush-fitting, floor-to-ceiling and accessible solutions

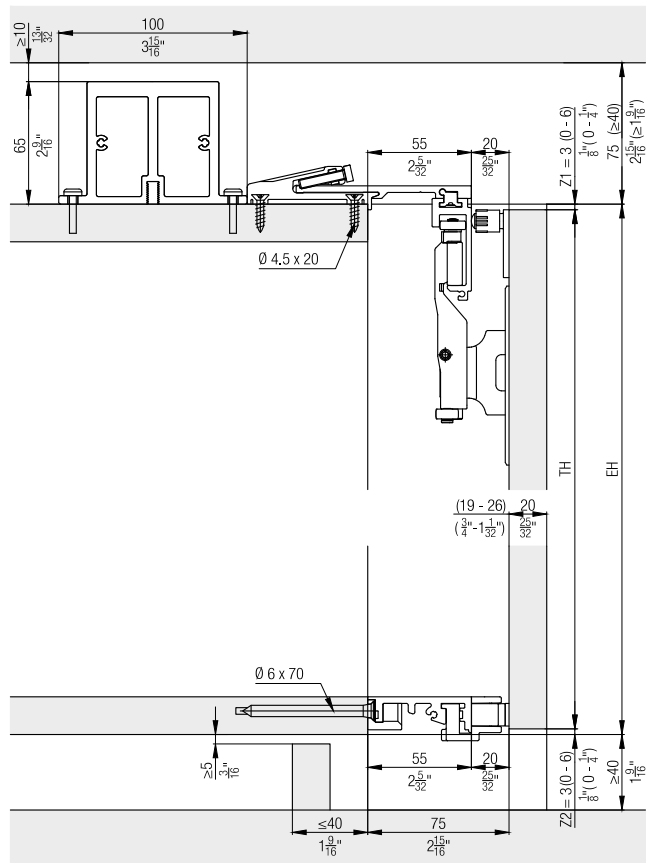
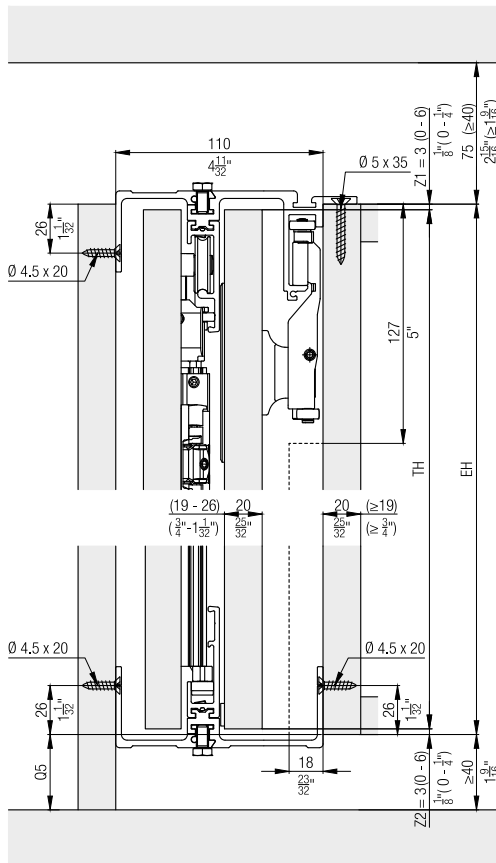
Technical specifications

- Max. 25 kg (55 lbs.)
- 1250–2600 mm (4'1 7/32" to 8'6 3/8")
- 300–700 mm (11 13/16" to 2'3 9/16")
- 19–26 mm (3/4" to 1 1/32")

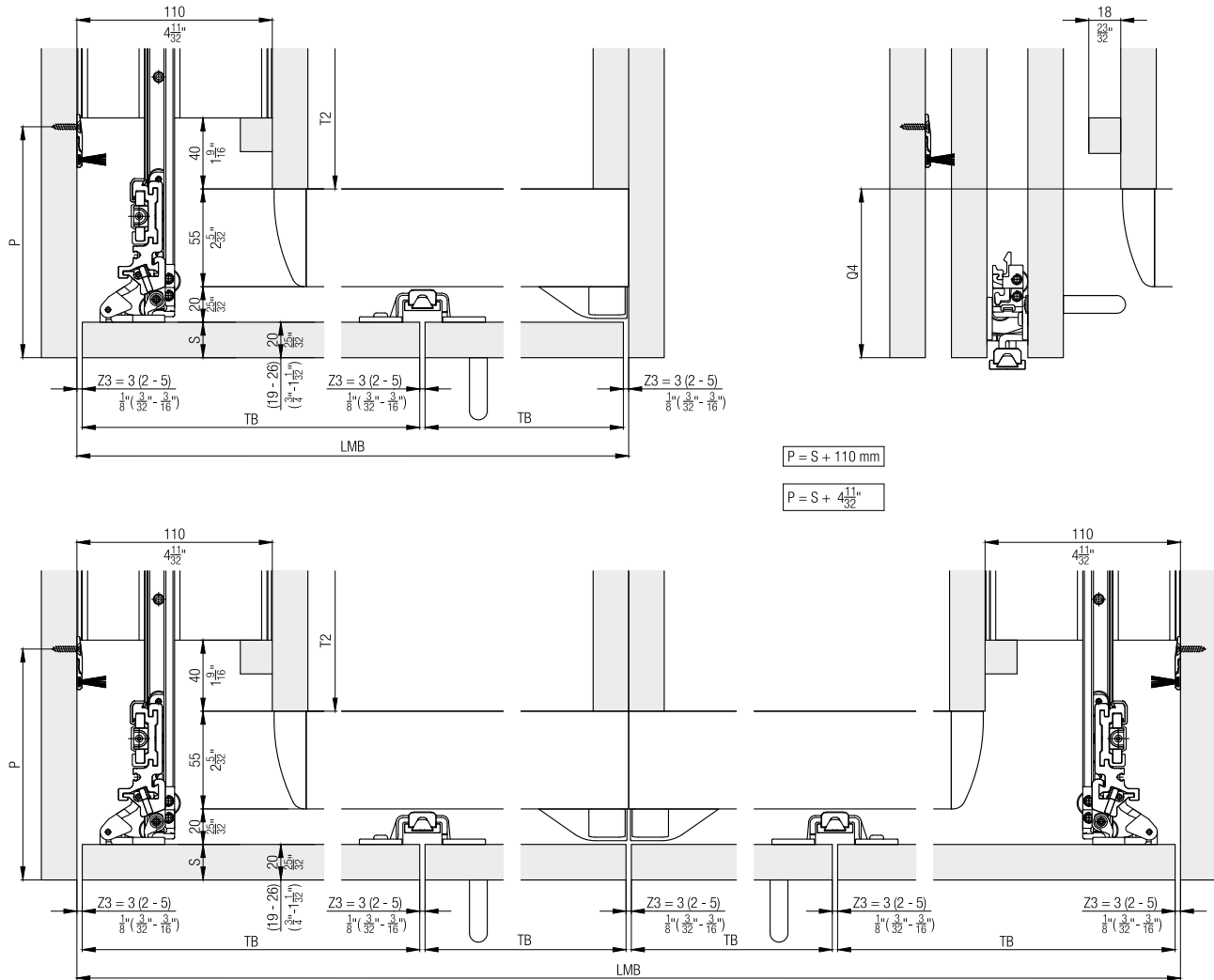


Installation examples

Front-hung cabinet fronts with base profile, 2 and 4 doors

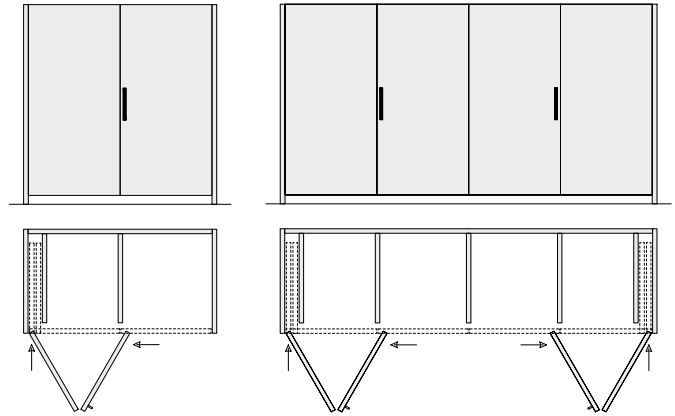


Systems with base profile, 2 and 4 doors



Set for 1 pair of folding doors,
door height 1250 to 1850 mm (4'1 7/32" to 6' 27/32")

	No.
Hawa Folding Concepta 25, left, aluminum, anodized, for 1 pair of folding doors	27636
Hawa Folding Concepta 25, right, aluminum, anodized, for 1 pair of folding doors	27637
Hawa Folding Concepta 25, left, aluminum, black anodized, for 1 pair of folding doors	27640
Hawa Folding Concepta 25, right, aluminum, black anodized, for 1 pair of folding doors	27641



Set consisting of:					No.
	27636	27637	27640	27641	
Scissor action, complete, 900 mm (2'11 7/16"), steel, zinc-plated	1	1	1	1	24087
Two-wheeled running gear, height-adjustable, zinc-plated matt	1	1	1	1	24686
Single-wheeled running gear, for folding door, nickel-plated	1	1	1	1	24054
Concealed press-fit cup, matt nickel-plated	1	1	1	1	23409
Concealed hinge with damper, nickel-plated, 3 pieces	1	1	1	1	27654
Concealed centre hinge, steel, dull nickel finish, 3 pieces	1	1	1	1	24088
Set of screws for concealed hinges, PH 4x20 mm (25/32")	1	1	1	1	25936
Rear scissor bearing, left, steel, zinc-plated	1		1		24117
Rear scissor guide, aluminum, anodized	1	1	1	1	25600
Front scissor guide, aluminum, anodized	1	1	1	1	25592
Upright, 1800 mm (5'10 7/8"), aluminum, anodized	1	1	1	1	22055

Continued table on next column

Table continued from previous column

Connector connecting profile, bottom left/top right, 500 mm (1'7 11/16"), aluminum, anodized	1	1	1	1	24170
Connector connecting profile, bottom right/top left, 500 mm (1'7 11/16"), aluminum, anodized	1	1	1	1	24171
Interior connector, bottom left, 645 mm (2'1 13/32"), aluminum, anodized	1		1		24021
Interior connector, top left, 645 mm (2'1 13/32"), aluminum, anodized	1		1		24107
Exterior connector, bottom left/top right, 645 mm (2'1 13/32"), aluminum, anodized	1	1	1	1	24027
Exterior connector, bottom right/top left, 645 mm (2'1 13/32"), aluminum, anodized	1	1	1	1	24028

Continued table on next page

Table continued from previous page

	Running track, left, 748 mm (2'5 7/16"), aluminum, anodized	1	1			24744
	Bottom guide channel, left, 748 mm (2'5 7/16"), aluminum, anodized	1	1			24746
	Running track, with left-hand curve piece, 1420 mm (4'7 29/32"), aluminum, anodized	1				24070
	Adapter for running track, plastic, anthracite, 4 pieces	1	1	1	1	23645
	Brush guide, plastic, black, set of 3 pieces	1	1	1	1	25815
	Covering screen for door clearance, 1870 mm (6'1 5/8"), aluminum, anodized	1	1			23540
	Soft closing system for end position, with cover caps, plastic, black	1	1	1	1	25887
	Pivot door damper, plastic, anthracite-grey	1	1	1	1	24063
	Upright guide, rattle proof, with plastic rollers	1	1	1	1	25656
	Stop cover cap, Hawa Folding Concepta, depth adjustable, top left/bottom right	1	1	1	1	27659
	Stop cover cap, Hawa Folding Concepta, depth adjustable, top right/bottom left	1	1	1	1	27660
	Cover plates, stainless steel, 1 pair	1	1			24739
	Stop bumper adjustable, plastic, anthracite-grey	1	1	1	1	23562


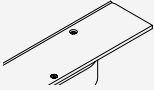
Continued table on next column

Table continued from previous column

	Fixing parts for covering screen for door clearance, of 3 pieces	1	1	1	1	23990
	Screw set, 4.5x20 mm, 40 pieces	1	1	1	1	24032
	Screw set, 5x35 mm, 4 pieces	1	1	1	1	24111
	Allen key, with handle, 3 mm (1/8")	1	1	1	1	13164
	Rear scissor bearing, right, galvanized steel		1		1	24097
	Interior connector, bottom right, 645 mm (2'1 13/32"), aluminum, anodized			1	1	24022
	Interior connector, top right, 645 mm (2'1 13/32"), aluminum, anodized			1	1	24108
	Running track, right, 748 mm (2'5 7/16"), aluminium, anodized			1	1	24745
	Bottom guide channel, right, 748 mm (2'5 7/16"), aluminium, anodized			1	1	24747
	Running track, with right-hand curve piece, aluminium, anodized			1		24071
	Running track, with left-hand curve piece, 1420 mm (4'7 29/32"), aluminum, black anodized				1	25484
	Covering screen for door clearance, 1870 mm (6'1 5/8"), aluminum, black anodized			1	1	25567








Continued table on next page

Table continued from previous page

	Cover plates, stainless steel, black, 1 pair			1	1	25865
	Running track, with right-hand curve piece, 1420 mm (4'7 29/32"), aluminum, black anodized				1	25485

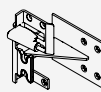


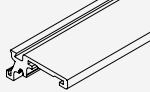
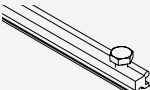
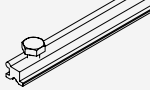
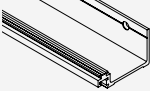
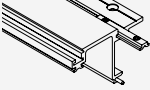
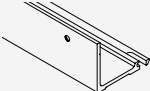
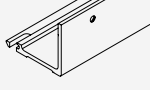
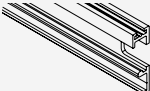
Set for 1 pair of folding doors, door height 1851 to 2600 mm (6' 7/8" to 8'6 3/8")

	No.
Hawa Folding Concepta 25, left, aluminum, anodized, for 1 pair of folding doors	27638
Hawa Folding Concepta 25, right, aluminum, anodized, for 1 pair of folding doors	27639
Hawa Folding Concepta 25, left, aluminum, black anodized, for 1 pair of folding doors	27642
Hawa Folding Concepta 25, right, aluminum, black anodized, for 1 pair of folding doors	27643

		27638	27639	27642	27643	No.
Set consisting of:						
	Scissor action complete, 1500 mm (4'11 1/16"), steel, galvanized	1	1	1	1	22594
	Two-wheeled running gear, height-adjustable, zinc-plated matt	1	1	1	1	24686
	Single-wheeled running gear, for folding door, nickel-plated	1	1	1	1	24054
	Concealed press-fit cup, matt nickel-plated	1	1	1	1	23409
	Concealed hinge with damper, nickel-plated, 4 pieces	1	1	1	1	27655
	Centre concealed hinge, dull nickel finish, set of 4 pieces	1	1	1	1	24218
	Set of screws for concealed hinges, PH 4x20 mm (25/32")	1	1	1	1	25936

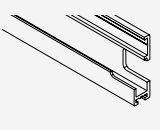
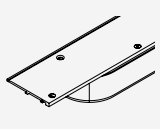
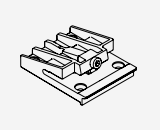
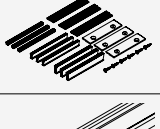
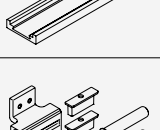
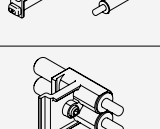
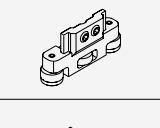
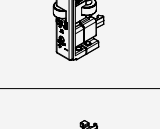
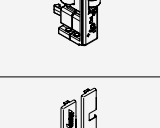
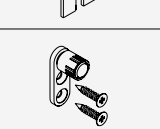
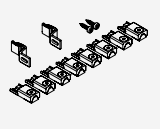

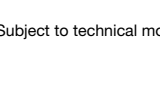
Continued table on next column

Table continued from previous column

	Rear scissor bearing, left, steel, zinc-plated	1		1		24117
	Rear scissor guide, aluminum, anodized	1	1	1	1	25600
	Front scissor guide, aluminum, anodized	1	1	1	1	25592
	Upright, 2500 mm (8'2 7/16"), aluminum, anodized	1	1	1	1	22056
	Connector connecting profile, bottom left/top right, 500 mm (1'7 11/16"), aluminum, anodized	1	1	1	1	24170
	Connector connecting profile, bottom right/top left, 500 mm (1'7 11/16"), aluminum, anodized	1	1	1	1	24171
	Interior connector, bottom left, 645 mm (2'1 13/32"), aluminum, anodized	1		1		24021
	Interior connector, top left, 645 mm (2'1 13/32"), aluminum, anodized	1		1		24107
	Exterior connector, bottom left/top right, 645 mm (2'1 13/32"), aluminum, anodized	1	1	1	1	24027
	Exterior connector, bottom right/top left, 645 mm (2'1 13/32"), aluminum, anodized	1	1	1	1	24028
	Running track, left, 748 mm (2'5 7/16"), aluminum, anodized	1		1		24744

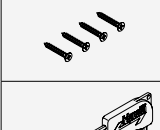
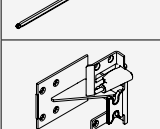
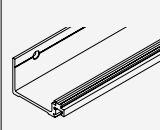
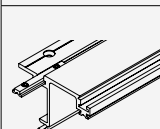
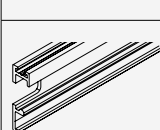
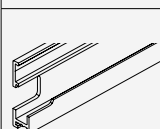
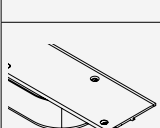
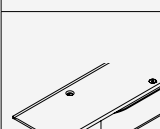
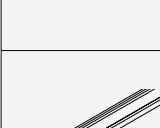
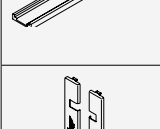
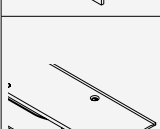

Continued table on next page

Table continued from previous page

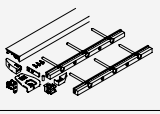
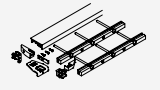
	Bottom guide channel, left, 748 mm (2'5 7/16"), aluminum, anodized	1	1			24746
	Running track, with left-hand curve piece, 1420 mm (4'7 29/32"), aluminum, anodized	1				24070
	Adapter for running track, plastic, anthracite-grey, 4 pieces	1	1	1	1	23645
	Brush guide, plastic, black, set of 3 pieces	1	1	1	1	25815
	Covering screen for door clearance, aluminum, anodized	1	1			23541
	Soft closing system for end position, with cover caps, plastic, black	1	1	1	1	25887
	Pivot door damper, plastic, anthracite-grey	1	1	1	1	24063
	Upright guide, rattle proof, with plastic rollers	1	1	1	1	25656
	Stop cover cap, Hawa Folding Concepta, depth adjustable, top left/bottom right	1	1	1	1	27659
	Stop cover cap, Hawa Folding Concepta, depth adjustable, top right/bottom left	1	1	1	1	27660
	Cover plates, stainless steel, 1 pair	1	1			24739
	Stop bumper adjustable, plastic, anthracite-grey	1	1	1	1	23562
	Fixing parts for covering screen for door clearance, set of 4 pieces	1	1	1	1	24306
	Screw set, 4.5x20 mm, 40 pieces	1	1	1	1	24032

Continued table on next column

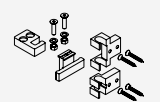
Table continued from previous column

	Screw set, 5x35 mm, 4 pieces	1	1	1	1	24111
	Allen key, with handle, 3 mm (1/8")	1	1	1	1	13164
	Rear scissor bearing, right, galvanized steel		1		1	24097
	Interior connector, bottom right, 645 mm (2'1 13/32"), aluminum, anodized		1		1	24022
	Interior connector, top right, 645 mm (2'1 13/32"), aluminum, anodized		1		1	24108
	Running track, right, 748 mm (2'5 7/16"), aluminium, anodized		1		1	24745
	Bottom guide channel, right, 748 mm (2'5 7/16"), aluminium, anodized		1		1	24747
	Running track, with right-hand curve piece, aluminum, anodized		1			24071
	Running track, with left-hand curve piece, 1420 mm (4'7 29/32"), aluminum, black anodized			1		25484
	Covering screen for door clearance, 2620 mm (8'7 5/32"), aluminum, black anodized			1	1	25504
	Cover plates, stainless steel, black, 1 pair			1	1	25865
	Running track, with right-hand curve piece, 1420 mm (4'7 29/32"), aluminum, black anodized				1	25485

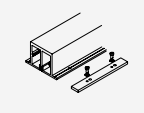
Base profiles

		mm (inch)	No.
	Base profile, aluminium, anodized	1,300 (4' 3 3/16")	24004
	Base profile, aluminium, black anodized	1,300 (4' 3 3/16")	25479

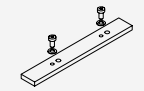

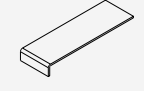
**Closing piston for espagnolette lock TERZA
Suitable for normal commercial espagnolette locks
with a profile bar diameter of 8 mm (5/16").**

		No.
	Lock catch and bracket for espagnolette lock, 2 pieces for 1 pair of folding doors	24005

Reinforcement profiles

		mm (inch)	No.
	Reinforcement profile, with running track connection plate, aluminium, anodized, pre-drilled	2,600 (8' 6 3/8")	24322
	Reinforcement profile, without connection plate, aluminium, anodized, pre-drilled	cut to size	24281

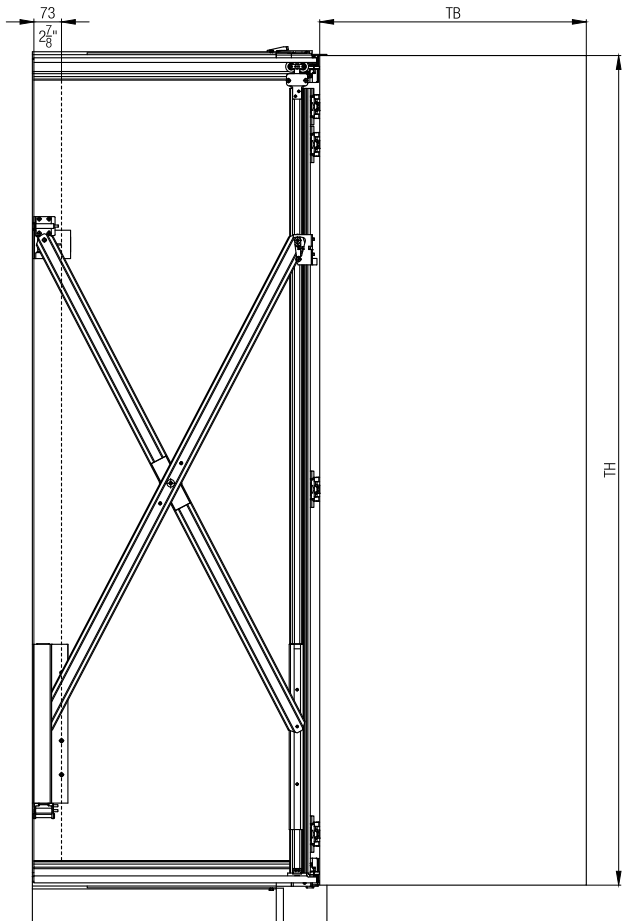
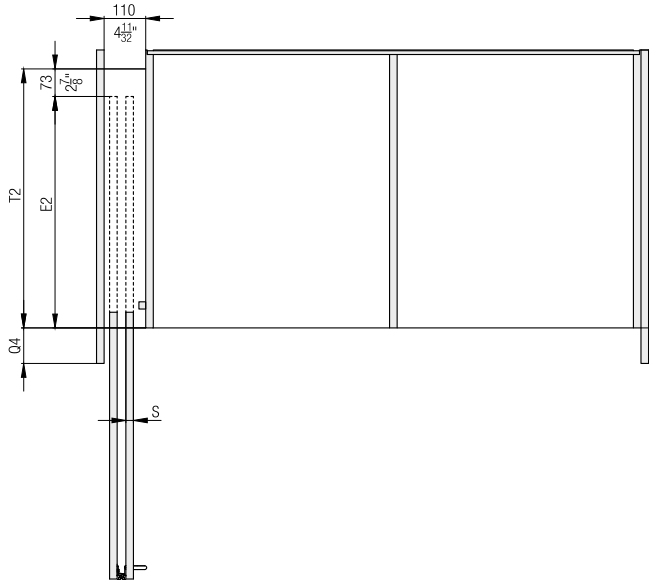
Accessories

		No.
	Running track connection plate, aluminium, anodized, pre-drilled	24321
	Magnetic centering part, with including drilling jig, aluminium, anodized	24006
	Center joint cover for running track, aluminium, anodized	27781
	Center joint cover for running track, aluminium, black anodized	27782

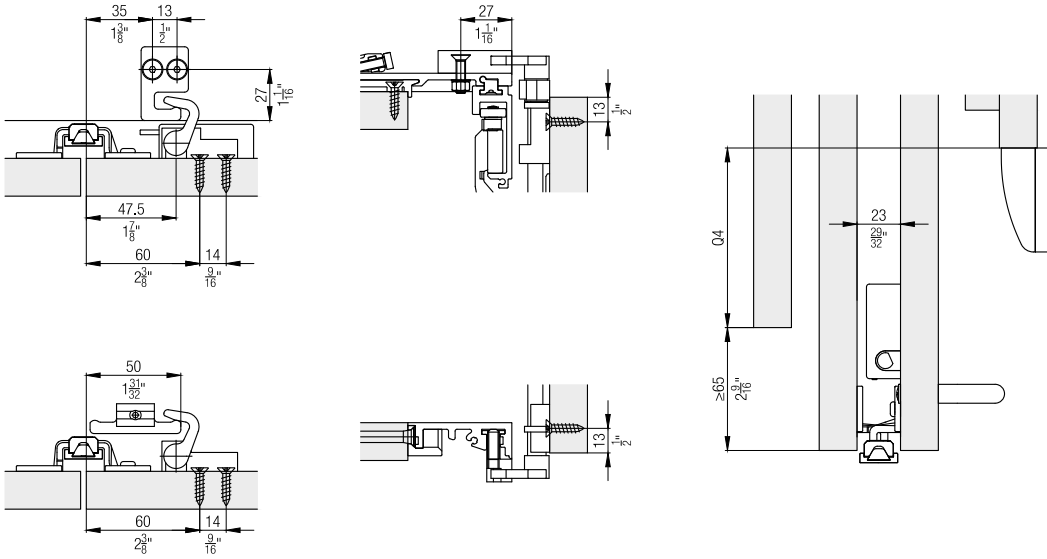
Fitting depth calculations

$T2 = TB + 73 \text{ mm} - Q4$	$T2 = TB + 2\frac{7}{8}'' - Q4$
$E2 = T2 - 73 \text{ mm}$	$E2 = T2 - 2\frac{7}{8}''$
$Q4 = 75 \text{ mm} + S$	$Q4 = 2\frac{15}{16}'' + S$

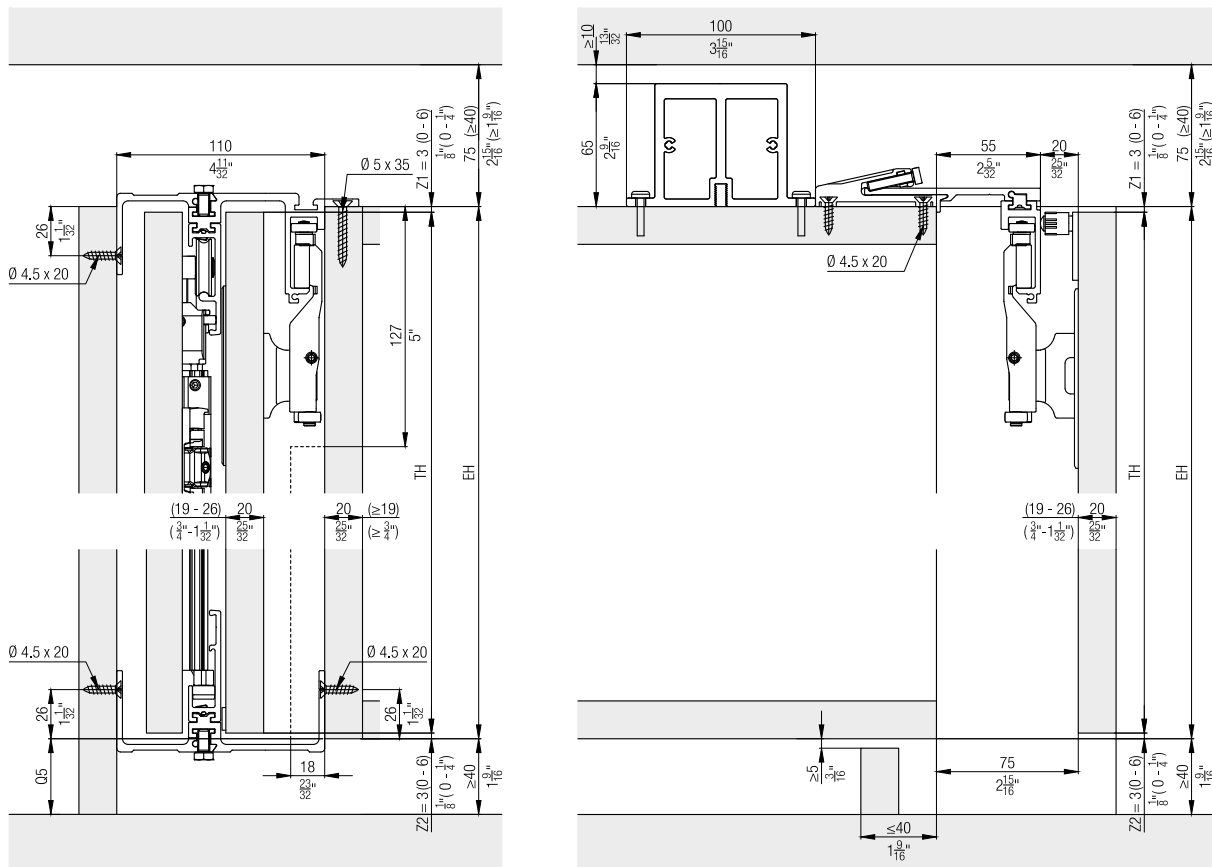
T2	TH	E2	T2	TH	E2
≤ 680 mm	1250 - 1850 mm	≤ 607 mm	≤ 2' 2 ²⁵ / ₃₂ "	4' 1 ⁷ / ₃₂ " - 6' 2 ⁷ / ₃₂ "	≤ 1' 11 ²⁹ / ₃₂ "
≤ 680 mm	1851 - 2600 mm	≤ 607 mm	≤ 2' 2 ²⁵ / ₃₂ "	6' 7 ⁷ / ₈ " - 8' 6 ³ / ₈ "	≤ 1' 11 ²⁹ / ₃₂ "



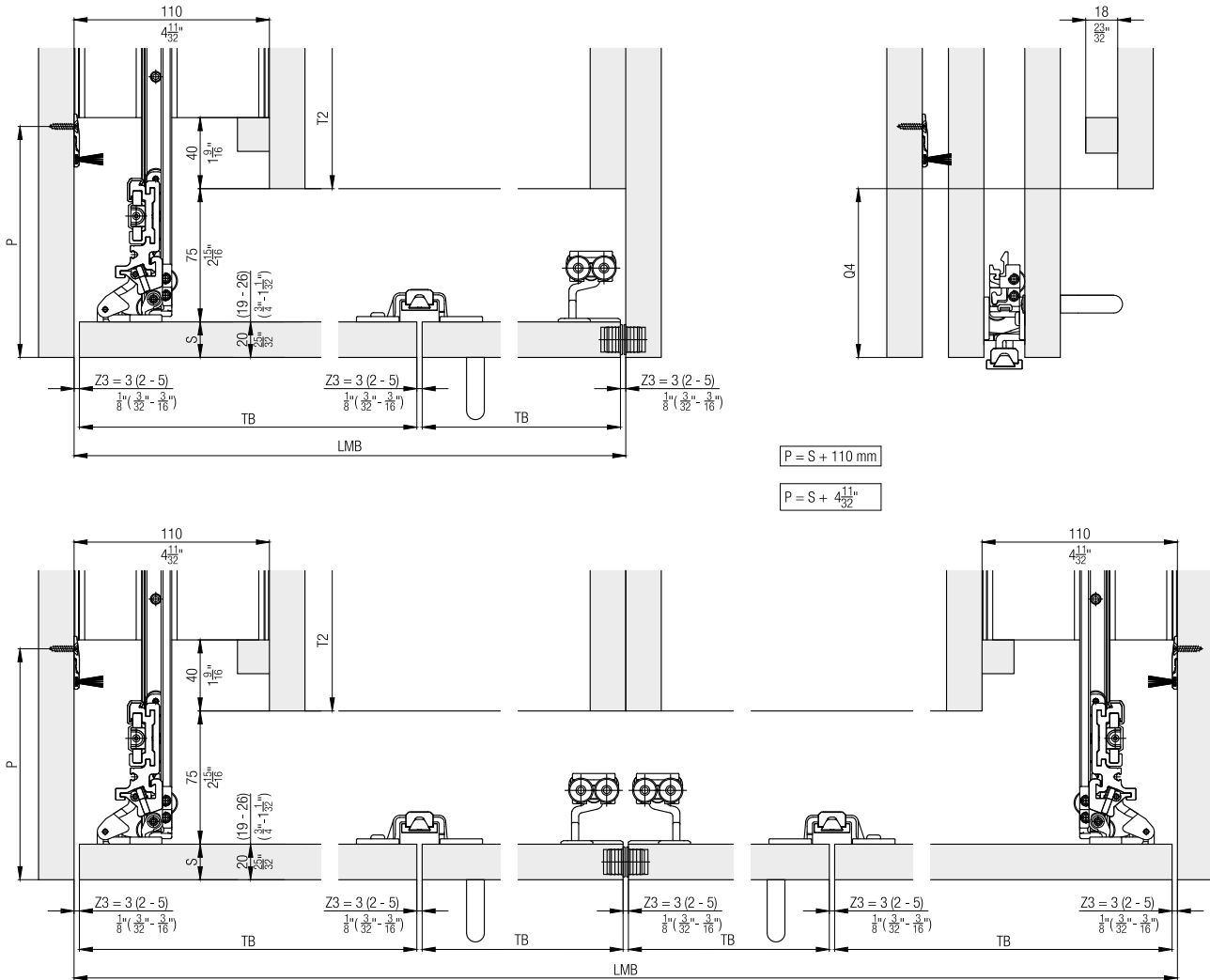
Espagnolette lock installation details



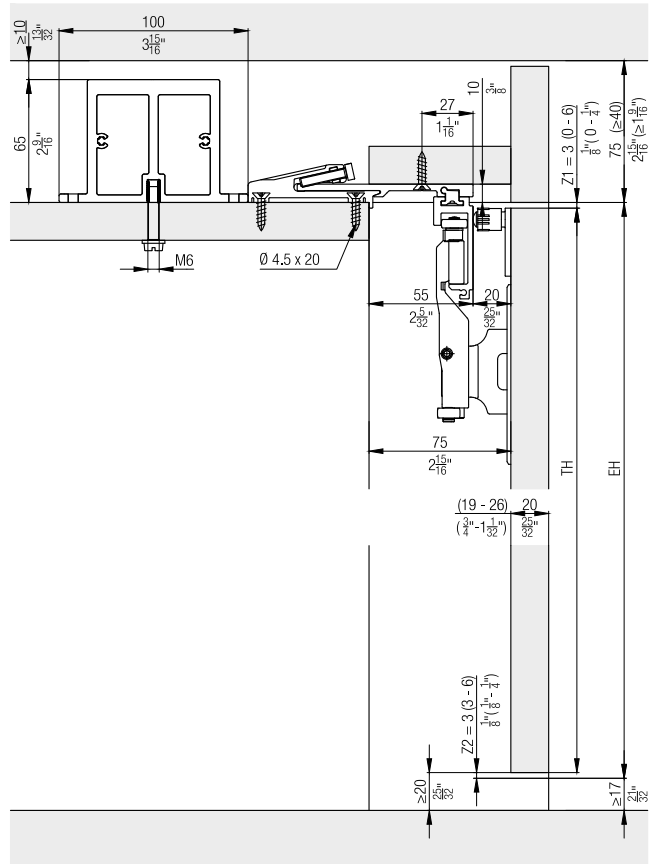
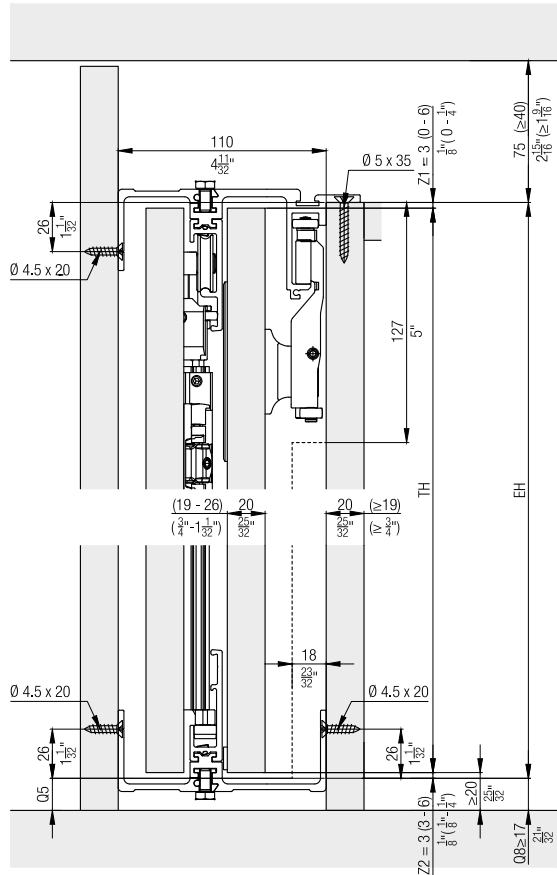
Further installation examples
Front-hung cabinet fronts without base profile, 2 and 4 doors



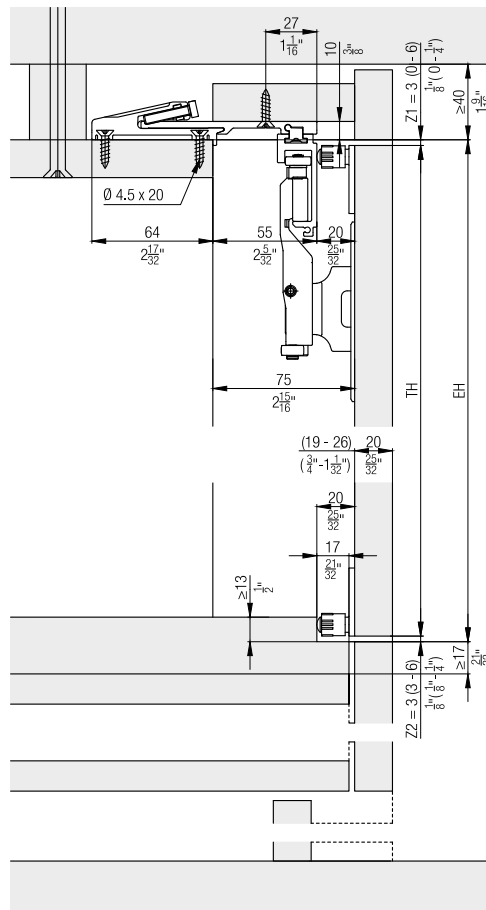
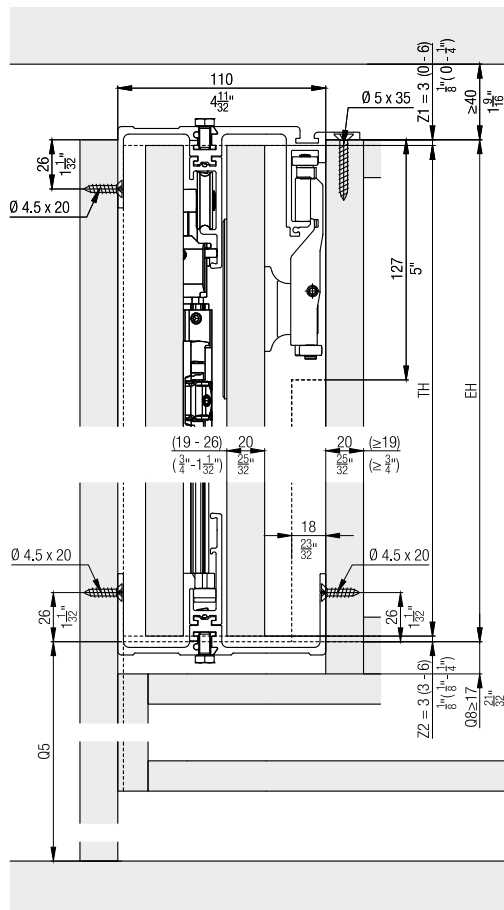
Systems without base profile, 2 and 4 doors



Room-high cabinet fronts, 2 and 4 doors

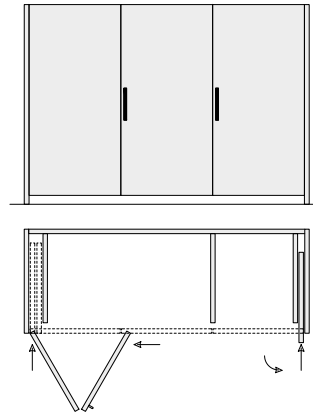


Superstructure cabinet fronts, 2 and 4 doors



**Set for 3-door systems in combination with
Hawa Concepta 30/40/50, door height 1851 to
2600 mm (6' 7/8" to 8'6 3/8")**

	No.
Hawa Folding Concepta 25, left, aluminum, anodized, for 3 doors systems	27644
Hawa Folding Concepta 25, right, aluminum, anodized, for 3 doors systems	27645
Hawa Folding Concepta 25, left, aluminum, black anodized, for 3 doors systems	27646
Hawa Folding Concepta 25, right, aluminum, black anodized, for 3 doors systems	27647



Set consisting of:						No.
		27644	27645	27646	27647	
	Scissor action complete, 1500 mm (4'11 1/16"), steel, galvanized	1	1	1	1	22594
	Two-wheeled running gear, height-adjustable, zinc-plated matt	1	1	1	1	24686
	Single-wheeled running gear, for folding door, nickel-plated	1	1	1	1	24054
	Concealed press-fit cup, matt nickel-plated	1	1	1	1	23409
	Concealed hinge with damper, nickel-plated, 4 pieces	1	1	1	1	27655
	Centre concealed hinge, dull nickel finish, set of 4 pieces	1	1	1	1	24218
	Set of screws for concealed hinges, PH 4x20 mm (25/32")	1	1	1	1	25936
	Rear scissor bearing, left, steel, zinc-plated	1		1		24117
	Rear scissor guide, aluminum, anodized	1	1	1	1	25600
	Front scissor guide, aluminum, anodized	1	1	1	1	25592

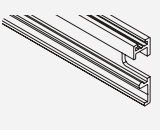
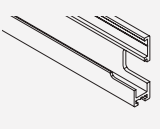

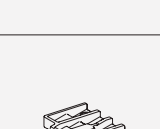
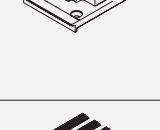
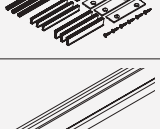
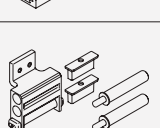
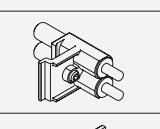
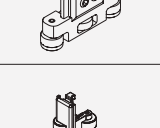
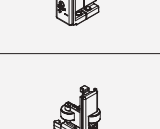
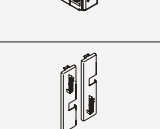

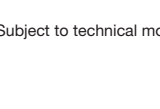
Continued table on next column

Table continued from previous column

	Upright, 2500 mm (8'2 7/16"), aluminum, anodized	1	1	1	1	22056
	Connector connecting profile, bottom left/top right, 500 mm (1'7 11/16"), aluminum, anodized	1	1	1	1	24170
	Connector connecting profile, bottom right/top left, 500 mm (1'7 11/16"), aluminum, anodized	1	1	1	1	24171
	Interior connector, bottom left, 645 mm (2'1 13/32"), aluminum, anodized	1		1		24021
	Interior connector, top left, 645 mm (2'1 13/32"), aluminum, anodized	1		1		24107
	Exterior connector, bottom left/top right, 645 mm (2'1 13/32"), aluminum, anodized	1	1	1	1	24027
	Exterior connector, bottom right/top left, 645 mm (2'1 13/32"), aluminum, anodized	1	1	1	1	24028



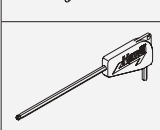
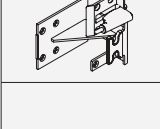
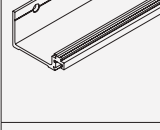
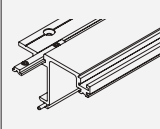
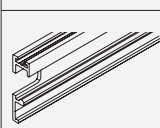
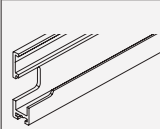
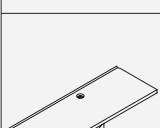



Continued table on next page

Table continued from previous page

	Running track, left, 748 mm (2'5 7/16"), aluminum, anodized	1	1			24744
	Bottom guide channel, left, 748 mm (2'5 7/16"), aluminum, anodized	1	1			24746
	Running track, with left-hand curve piece, 2120 mm (6'11 15/32") aluminium, anodized	1				24913
	Adapter for running track, plastic, anthracite, 6 pieces, for cabinet width 1421-2120 mm (4'7 15/16"-6'11 15/32")	1	1	1	1	24870
	Brush guide, plastic, black, set of 3 pieces	1	1	1	1	25815
	Covering screen for door clearance, aluminum, anodized	1	1			23541
	Soft closing system for end position, with cover caps, plastic, black	1	1	1	1	25887
	Pivot door damper, plastic, anthracite-gray	1	1	1	1	24063
	Upright guide, rattle proof, with plastic rollers	1	1	1	1	25656
	Stop cover cap, Hawa Folding Concepta, depth adjustable, top left/bottom right	1	1	1	1	27659
	Stop cover cap, Hawa Folding Concepta, depth adjustable, top right/bottom left	1	1	1	1	27660
	Cover plates, stainless steel, 1 pair	1	1			24739
	Stop bumper adjustable, plastic, anthracite-grey	2	2	2	2	23562


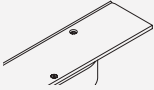
Continued table on next column

Table continued from previous column

	Fixing parts for covering screen for door clearance, set of 4 pieces	1	1	1	1	24306
	Screw set, 4.5x20 mm, 40 pieces	1	1	1	1	24032
	Screw set, 5x35 mm, 4 pieces	1	1	1	1	24111
	Allen key, with handle, 3 mm (1/8")	1	1	1	1	13164
	Rear scissor bearing, right, galvanized steel		1		1	24097
	Interior connector, bottom right, 645 mm (2'1 13/32"), aluminum, anodized		1		1	24022
	Interior connector, top right, 645 mm (2'1 13/32"), aluminum, anodized		1		1	24108
	Running track, right, 748 mm (2'5 7/16"), aluminium, anodized		1		1	24745
	Bottom guide channel, right, 748 mm (2'5 7/16"), aluminium, anodized		1		1	24747
	Running track, with right-hand curve piece, 2120 mm (6'11 15/32") aluminium, anodized		1			24914
	Running track, with left-hand curve piece, 2120 mm (6'11 15/32"), aluminum, black anodized			1		25486
	Covering screen for door clearance, 2620 mm (8'7 5/32"), aluminum, black anodized		1	1		25504

Continued table on next page

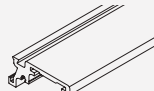





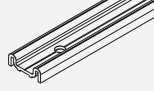


Table continued from previous page

	Cover plates, stainless steel, black, 1 pair			2	2	25865
	Running track, with right-hand curve piece, 2120 mm (6'11 15/32"), aluminium, black anodized				1	25487

For 3-door cabinets, 1 Hawa Concepta 30, 40 or 50 set should also be ordered.


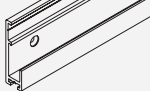
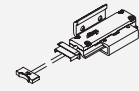








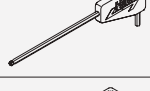
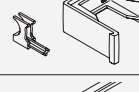
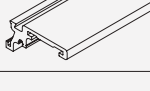


	No.
Hawa Concepta 30, for 1 door	27649
Hawa Concepta 40, for 1 door	27650
Hawa Concepta 50, for 1 door	27651

Set consisting of:

		27649	27650	27651	No.
	Upright, 2300 mm (7'6 9/16"), alu plain, anodized	1			24699
	Scissor action, complete, steel, galvanized	1			22593
	Front scissor guide, aluminum, anodized	1	1	1	25592
	Rear scissor guide, aluminum, anodized	1	1	1	25596
	Rear scissor bearing, 55 mm (2 5/32"), steel, galvanized	1	1	1	25855
	Concealed hinge with damper, nickel-plated, 3 pieces	1			27654
	Spacer profile, 860 mm (2'9 27/32"), pre-drilled, plastic, black	1	1	1	22861
	Brush guide, plastic, black, set of 3 pieces	1	1	1	25815
	Upright guide, rattle proof, with plastic rollers	2	1	1	25656

Continued table on next column

Table continued from previous column

	Torsion plate	1			27704
	Bottom guide channel, 896 mm (2'11 9/32"), aluminium, anodized, pre-drilled	2	1	1	24535
	Stop damper, with retaining bracket	1	1	1	24660
	Door retractor 30/40, with damper, plastic, black	1	1		25813
	Stop cover cap Hawa Concepta, depth adjustable, top left/bottom right	1	1	1	27657
	Stop cover cap Hawa Concepta, depth adjustable, top right/bottom left	1	1	1	27658
	Cover plates, stainless steel, 1 pair	1	1	1	24739
	Soft closing system for end position, with cover caps, plastic, black	1	1	1	25862
	Set of screws for concealed hinges, 4x16 mm (5/8"), set of 10 pieces	1	1	1	25935
	Screw set, 4,5x20 mm (25/32"), set of 22 pieces	1	1	1	22451
	Set of screws for spacer profile, PH 4x16 mm (5/8"), set of 7 pieces	1	1	1	25562
	Allen key, with handle, 3 mm (1/8")	1	1	1	13164
	Installation aid, plastic, red	1	1	1	25816
	Upright, 2500 mm (8'2 7/16"), aluminium, anodized			1	22056
	Scissor action complete, 1500 mm (4'11 1/16"), steel, galvanized			1	22594
	Concealed hinge with damper, nickel-plated, 4 pieces			1	27655

Continued table on next column

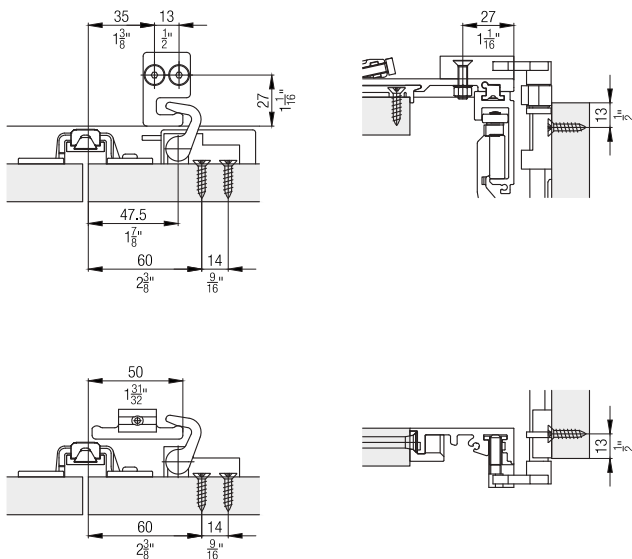
Table continued from previous page

	Two-wheeled running gear, height-adjustable, with torsion plate, zinc-plated matt	1	1	24955
	Running track, 896 mm (2'11 9/32"), aluminium, anodized, pre-drilled	1	1	24528
	Upright, 2760 mm (9' 21/32"), aluminium, anodized		1	22057
	Concealed hinge with damper, nickel-plated, 5 pieces		1	27656
	Door retractor 25/50, with damper, plastic, black		1	25814

Base profiles

		mm (inch)	No.
	Base profile, aluminium, anodized	2,000 (6' 6 3/4 ")	25481
	Base profile, aluminium black anodized	2,000 (6' 6 3/4 ")	25480

Espagnolette lock installation details



Reinforcement profiles

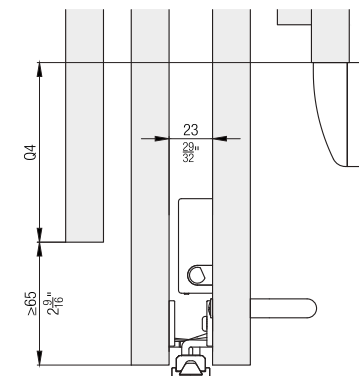
		mm (inch)	No.
	Reinforcement profile, with running track connection plate, aluminium, anodized, pre-drilled	2,600 (8' 6 3/8 ")	24322
	Reinforcement profile, without connection plate, aluminium, anodized, pre-drilled	cut to size	24281

Closing piston for espagnolette lock TERZA Suitable for normal commercial espagnolette locks with a profile bar diameter of 8 mm (5/16").

		No.
	Lock catch and bracket for espagnolette lock, 2 pieces for 1 pair of folding doors	24005

Accessories

		No.
	Running track connection plate, aluminium, anodized, pre-drilled	24321
	Magnetic centering part, with including drilling jig, aluminium, anodized	24006
	Center joint cover for running track, aluminium, anodized	27781
	Center joint cover for running track, aluminium, black anodized	27782



Fitting depth calculations

$T2 = TB + 73 \text{ mm} - Q4$
$E2 = T2 - 73 \text{ mm}$
$Q4 = 75 \text{ mm} + S$

T2	TH	E2
$\leq 680 \text{ mm}$	1851 - 2600 mm	$\leq 607 \text{ mm}$

$T1 = TB - M + 73 \text{ mm}$
$E1 = T1 - 73 \text{ mm}$

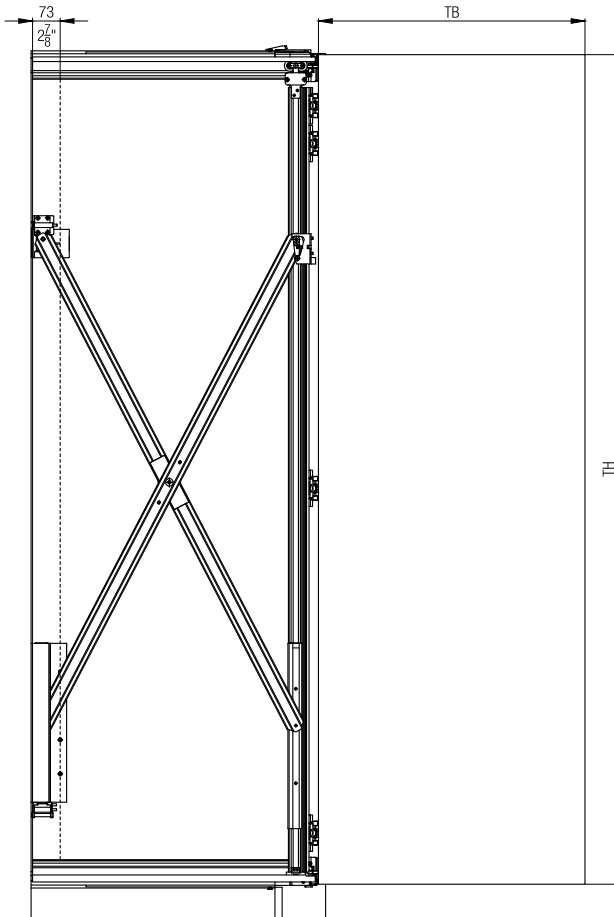
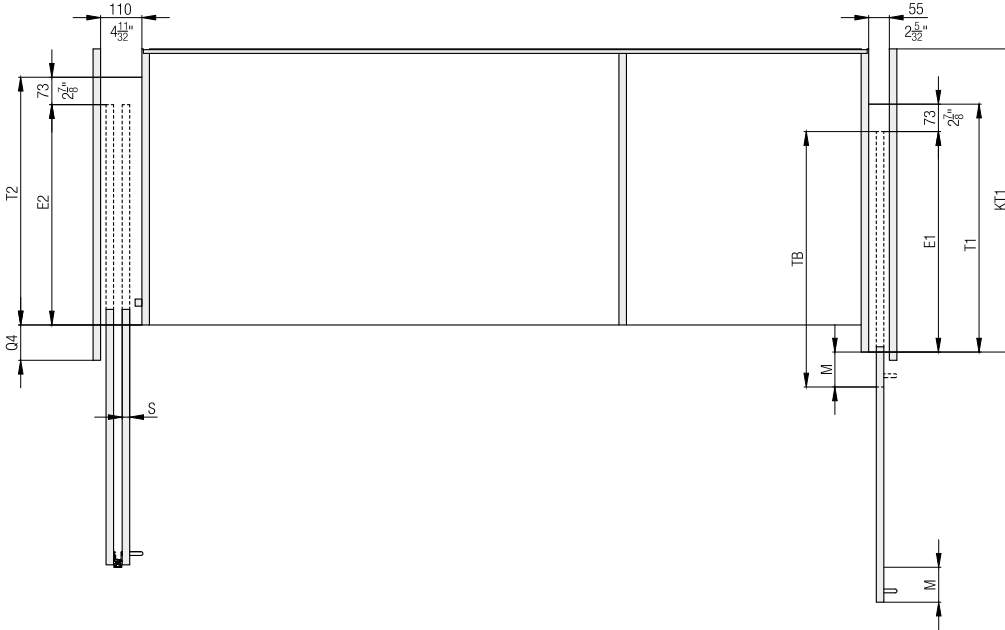
	T1	TH	E1
Hawa Concepta 30	$\leq 900 \text{ mm}$	1851 - 2300 mm	300 - 827 mm
Hawa Concepta 40	$\leq 900 \text{ mm}$	1851 - 2500 mm	300 - 827 mm
Hawa Concepta 50	$\leq 900 \text{ mm}$	2301 - 2850 mm	300 - 827 mm

$T2 = TB + 2\frac{7}{8}'' - Q4$
$E2 = T2 - 2\frac{7}{8}''$
$Q4 = 2\frac{9}{16}'' + S$

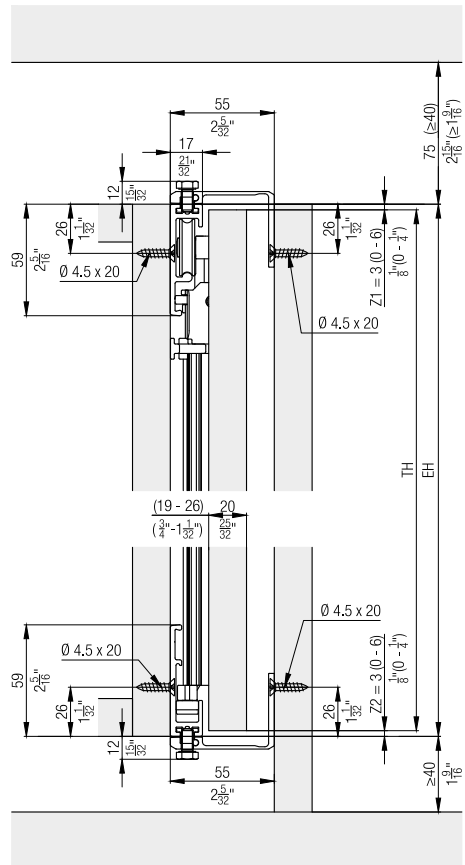
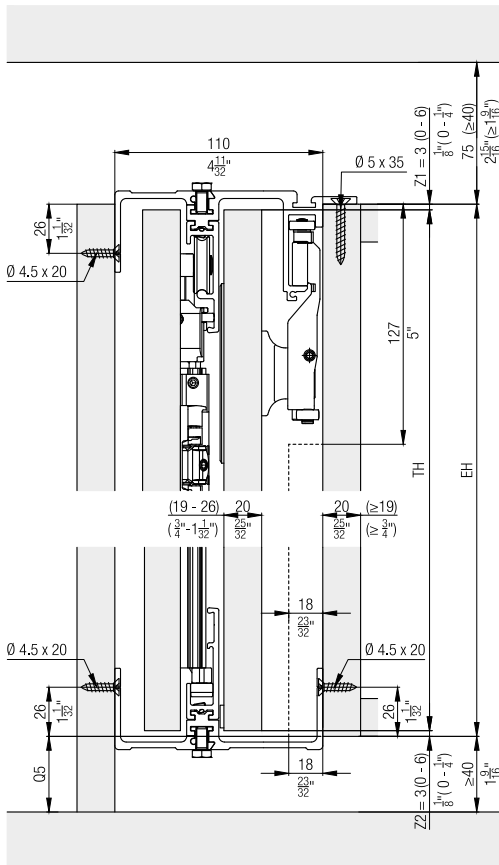
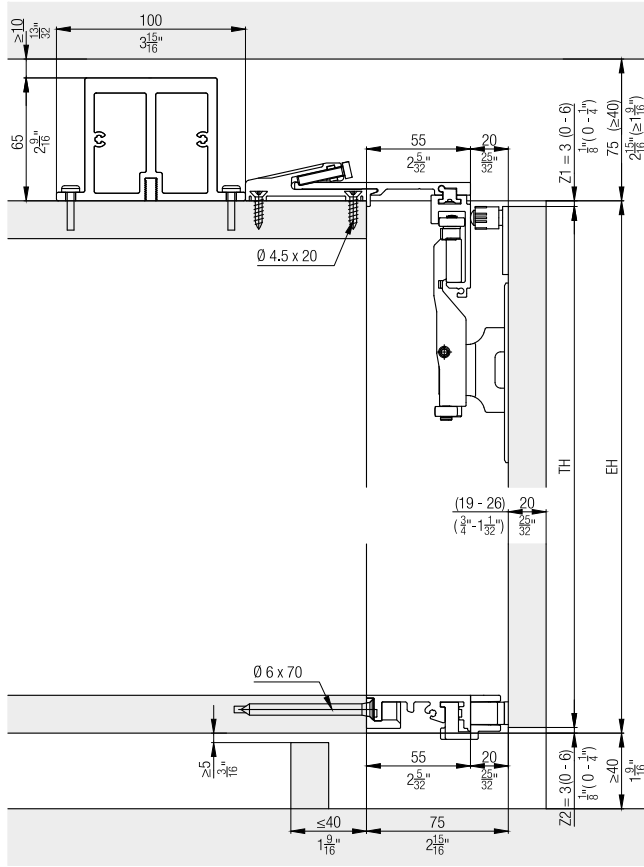
T2	TH	E2
$\leq 2' 2\frac{25}{32}''$	6' $\frac{7}{8}''$ - 8' $\frac{63}{8}''$	$\leq 1' 11\frac{29}{32}''$

$T1 = TB - M + 2\frac{7}{8}''$
$E1 = T1 - 2\frac{7}{8}''$

	T1	TH	E1
Hawa Concepta 30	$\leq 2' 11\frac{7}{16}''$	6' $0\frac{7}{8}''$ - 7' $6\frac{9}{16}''$	11 $\frac{13}{16}''$ - 2' $8\frac{9}{16}''$
Hawa Concepta 40	$\leq 2' 11\frac{7}{16}''$	6' $0\frac{7}{8}''$ - 8' $2\frac{7}{16}''$	11 $\frac{13}{16}''$ - 2' $8\frac{9}{16}''$
Hawa Concepta 50	$\leq 2' 11\frac{7}{16}''$	7' $6\frac{19}{32}''$ - 9' $4\frac{7}{32}''$	11 $\frac{13}{16}''$ - 2' $8\frac{9}{16}''$

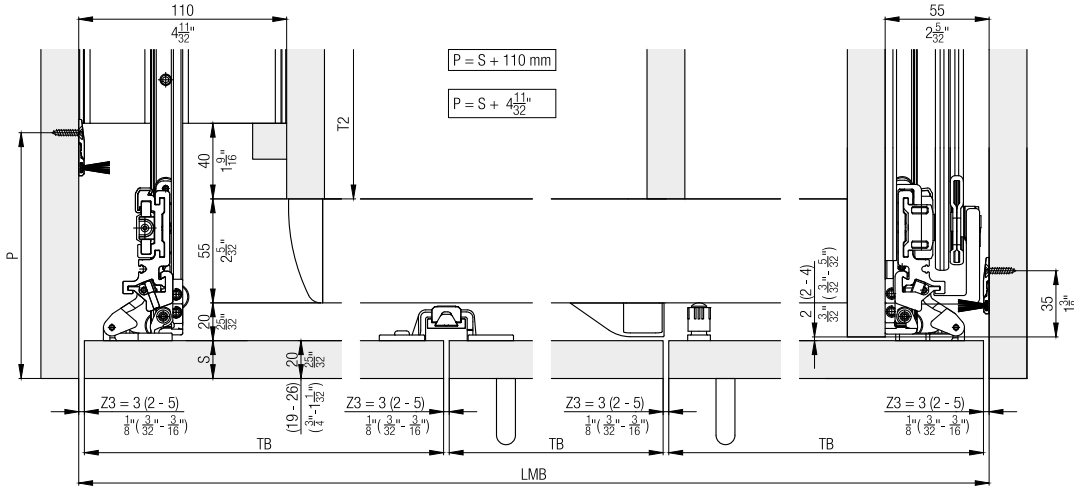


Further installation examples
 Front-hung cabinet fronts with base profile, 3 doors

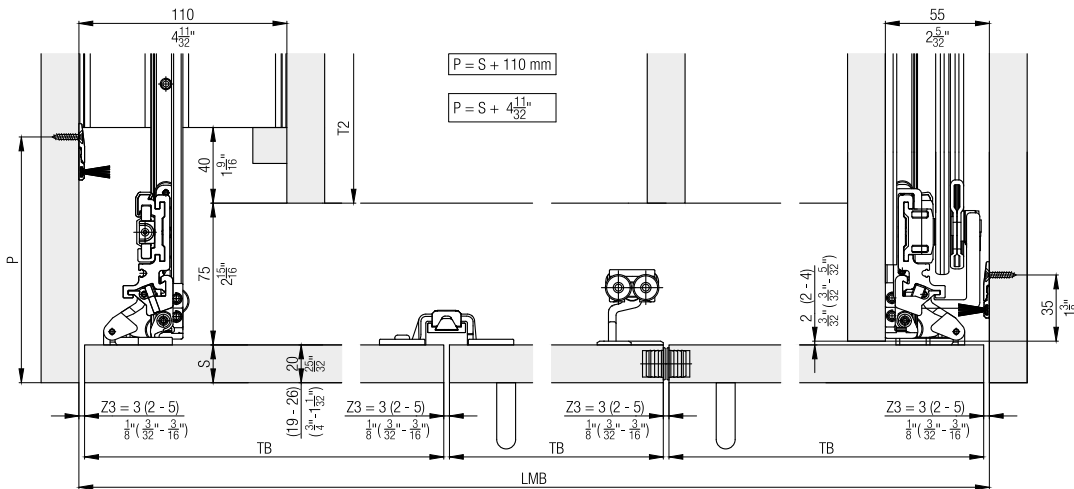


Subject to technical modifications. Metric specifications are exact. Inches are approximate.

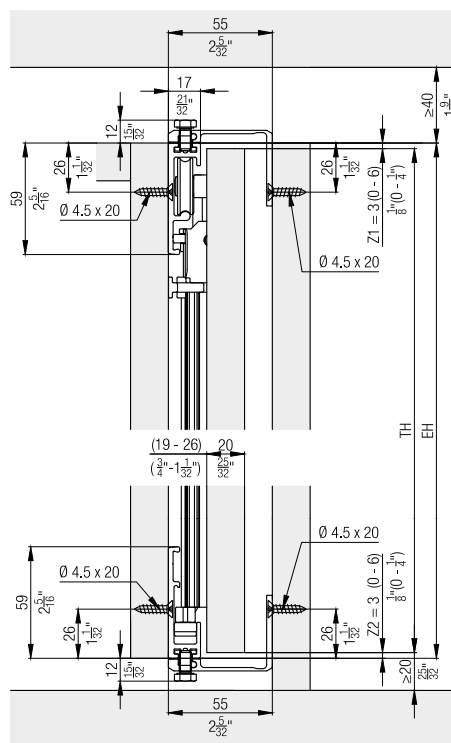
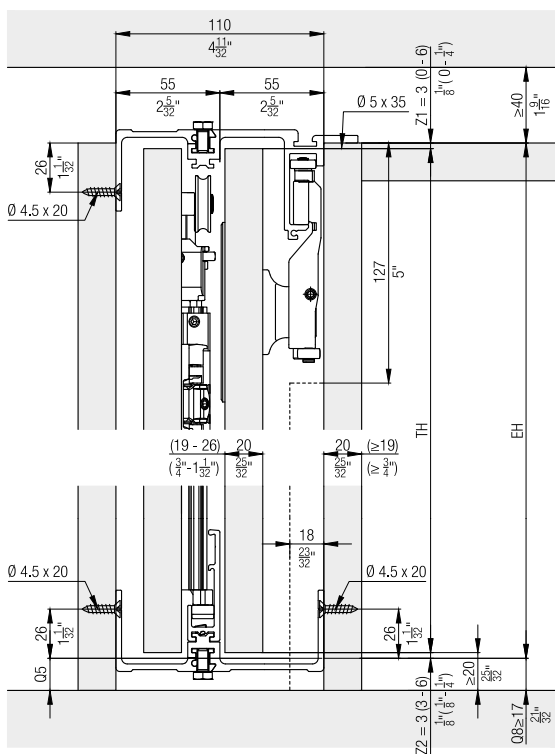
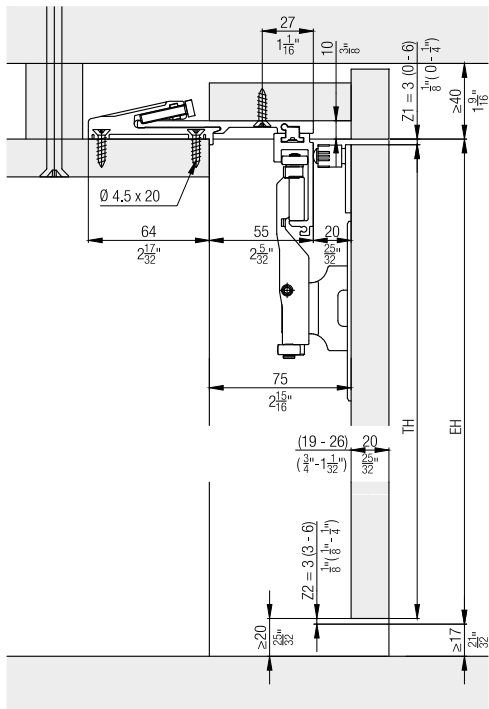
Systems with base profile, 3 doors



Systems without base profile, 3 doors



Room-high cabinet fronts without base profile, 3 doors



Accessories

- Straightening fitting from page 236

Planning/execution

Configure with just a few clicks on www.foldingconcepta.hawa.com

Further information about the product can be found on www.hawa.com.
For manufacturing reasons, running tracks may have slight colour differences.



Everything for more openness and transparency

Solutions for glass applications

The natural aesthetics of glass, combined with the well thought-out functionality of our sliding systems: A fantastic recipe for success which creates freedom in the furniture and for its planners and fabricators. And does not only make innovative constructions with glass possible, but provides the inspiration for them time and time again.



Glass sliding doors

Modern living has a tendency towards reduction, which is therefore increasing the functional and design demands which are made of each individual furniture item. Sliding doors made from glass take on this challenge: They visually enhance constructions, make exciting material combinations possible and set interesting accents in any environment. The versatile range of pioneering hardware solutions from Hawa Sliding Solutions brings out all of these advantages with the best sliding characteristics, a filigree design and innovative technology in a perfect way.



Discover our fitting solutions
for glass sliding doors
from **Page 198**

Hawa Clipo for glass sliding doors

Aesthetics and functionality in perfect harmony

The same qualities that predestine the Hawa Clipo for wooden sliding doors are also brought to bear when dealing with glass. Be it a display case in shopfitting or a designer tall cabinet in the living area, be it one or two glass doors, or doors weighing 16, 26 or 36 kg: The Hawa Clipo will fulfill your ideas with exactly the right fitting version.

You will also find the right version during installation – no glass processing whatsoever is required because of the intelligent mounting options. The combination of glass doors with fixed glazing can also be realized without problems. The combination of the top quality running gear and optimized bottom guides provides a high degree of convenience and low decibel values when sliding. And the technology takes the transparency of the material into consideration from a visual point of view: The self and soft closing mechanism with retaining function at both sides is invisibly integrated in the running track, for example.



Area of application

In private, business and sales premises, such as for display cabinets in exhibitions, partitioning at the reception desk, wall units in kitchens, occasional furniture in the public or private sector and much more.

System advantages





Flexibility Wide range of design and installation versions, also thanks to combination of hardware components

Productivity Easy installation with tool-less clip-on system and convenient height adjustment

Comfort Smooth, soft running
Invisible soft closing mechanism, integrated in running track

Aesthetics Filigree appearance with simple aluminum profiles

Technical specifications

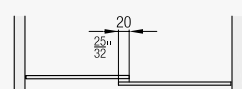
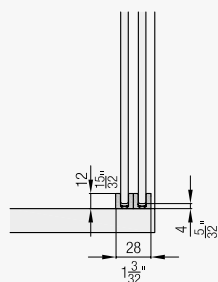
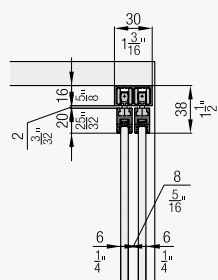
	max.	16/26/36 kg
	max.	2000 mm
	max.	1000 mm
	Glass	4–8 mm

Good to know (accessories)

- Various handles
- Hawa Soft closing mechanism

Installation examples

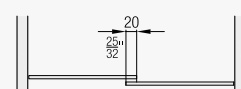
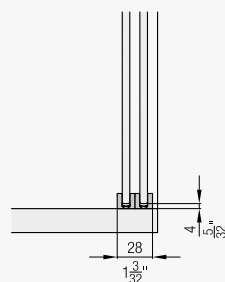
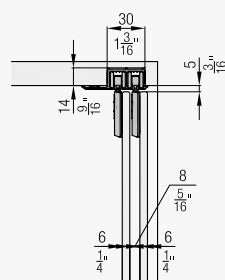
Hawa Clipo 16 GPK IS



Product range

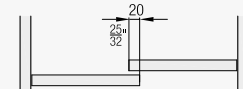
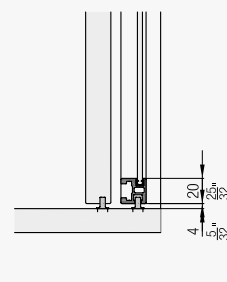
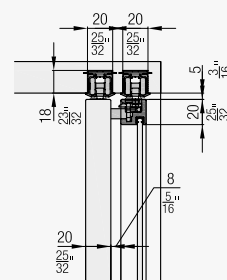
Hawa Clipo 16 GPK IS
Hawa Clipo 36 GPK IS

Hawa Clipo 16 GK IS



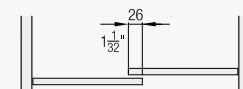
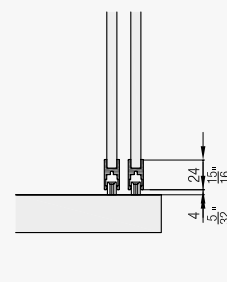
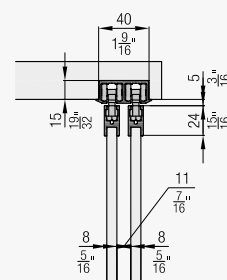
Hawa Clipo 16 GK IS
Hawa Clipo 16 GS IS

Hawa Clipo 26 GR IS



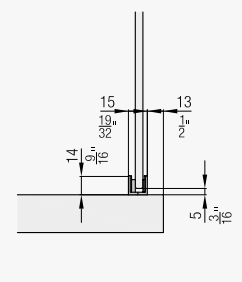
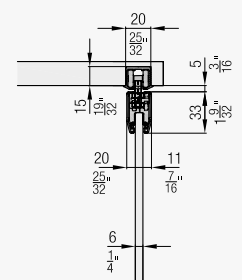
Hawa Clipo 26 GR IS

Hawa Clipo 36 GPPK IS



Hawa Clipo 16 GPPK IS
Hawa Clipo 36 GPPK IS

Hawa Clipo 36 G IS











Hawa Clipo 36 G IS


Set for 2 glass doors up to 16 kg (35 lbs.), with height adjustment

	No.
Hawa Clipo 16 GK IS, for 2 doors	053.3313.071

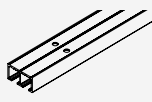
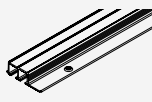
Set consisting of:

		053.3313.071	No.
	Running gear	4	053.0297.171
	Hawa Clipo 16/Hawa Regal 16 C stopper, plastic, gray	2	053.3215.071
	Fixing plate, for glue fixing, zinc diecast	4	053.3311.071
	Door follower, plastic, grey	1	053.3075.071
	Socket button head screw, M3x6 mm (1/8"x 1/4"), steel, zinc-plated	1	600.0000.679
	Hex jam nut M3, steel, zinc-plated	1	600.0000.680
	Bottom guide, plastic, grey	2	053.3253.001
	Flat countersunk head chipboard screw, 3x12 mm (1/8"x15/32"), steel, zinc-plated	2	766.5030.112

Adhesive

	No.	
	Glue penloc GTI, 12 ml	098.0026.000

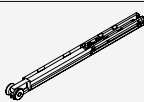
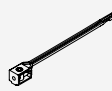

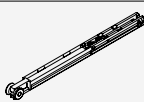
Running tracks

		mm (inch)	No.
	G: Double running track, for screw fixing, aluminum, anodized	2,500 (8' 2 7/16")	053.3247.250
		3,500 (11' 5 25/32")	053.3247.350
		6,000 (19' 8 7/32")	053.3247.600
	H: Double running track, aluminum, pre-drilled	2,500 (8' 2 7/16")	053.3248.250
		3,500 (11' 5 25/32")	053.3248.350
		6,000 (19' 8 7/32")	053.3248.600




Soft close up to 8/16 kg (17/35 lbs.)

	No.
Soft close Hawa Clipo 16/Hawa Regal C 16, up to 8 kg (17 lbs.)	053.3332.071
Soft close Hawa Clipo 16/Hawa Regal C 16, up to 16 kg (35 lbs.)	053.3332.072


Set consisting of:

		053.3332.071	053.3332.072	No.
	Damper, up to 8 kg (17 lbs.)	2		053.3330.071
	Trigger, with stopper	2	2	053.3331.071
	Cross recessed pan head screw, 2.2x8 mm (3/32"x5/16"), steel, zinc-plated	2	2	600.0000.482
	Damper, up to 16 kg (35 lbs.)		2	053.3330.072

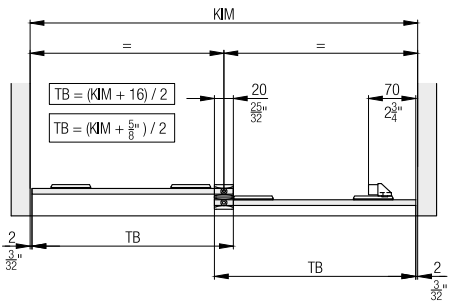
Handles

	No.	
	Handle, for glue fixing, 64 mm (2 17/32"), plastic, chrome-plated, matt, 2-piece set	053.3323.971
	Finger-pull-handle, for glue fixing, 30 mm (1 3/16"), aluminum, anodized, 2-piece set	053.3091.982
	Finger-pull-handle, for glue fixing, 30 mm (1 3/16"), aluminum, anodized, 50-piece set	053.3091.983
	Finger-pull-handle, for glue fixing, 40 mm (1 9/16"), aluminum, anodized	053.3158.901

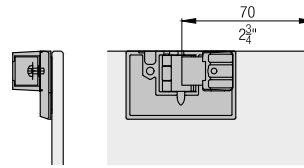
Accessories

	No.	
	Track cleaner, plastic, red	040.3142.071

Calculations



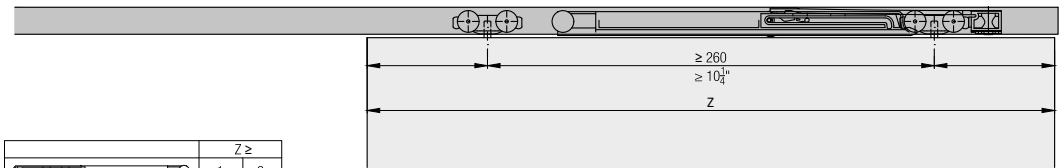
Door follower



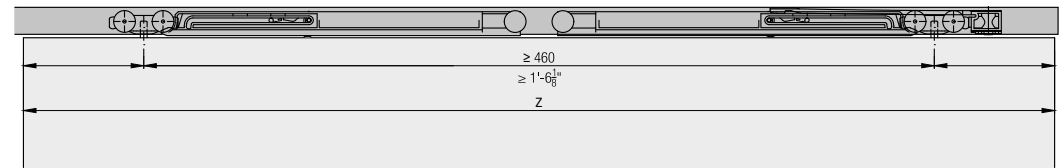
Soft close



	Z ≥	
	1	2
Hawa Clipo 16 H IS	1' 3 ³ / ₄ "	1' 11 ⁵ / ₈ "
Hawa Clipo 16 H MS	1' 5 ¹ / ₄ "	2' 1 ¹ / ₈ "
Hawa Clipo 16 H FS	1' 5 ¹ / ₄ "	2' 1 ¹ / ₈ "
Hawa Clipo 16 HM IS	1' 3 ³ / ₄ "	1' 11 ⁵ / ₈ "
Hawa Clipo 16 GK IS	1' 3 ³ / ₄ "	1' 11 ⁵ / ₈ "
Hawa Clipo 16 GS IS	1' 3 ³ / ₄ "	1' 11 ⁵ / ₈ "
Hawa Clipo 16 GPK IS	1' 3 ³ / ₄ "	1' 11 ⁵ / ₈ "
Hawa Clipo 16 GPPK IS	1' 3 ³ / ₄ "	1' 11 ⁵ / ₈ "



	Z ≥	
	1	2
Hawa Clipo 16 H IS	400	600
Hawa Clipo 16 H MS	438	638
Hawa Clipo 16 H FS	438	638
Hawa Clipo 16 HM IS	400	600
Hawa Clipo 16 GK IS	400	600
Hawa Clipo 16 GS IS	400	600
Hawa Clipo 16 GPK IS	400	600
Hawa Clipo 16 GPPK IS	400	600



Accessories



– Glass recommendations from page 249

Planning/execution





Further information about the product can be found on www.hawa.com.

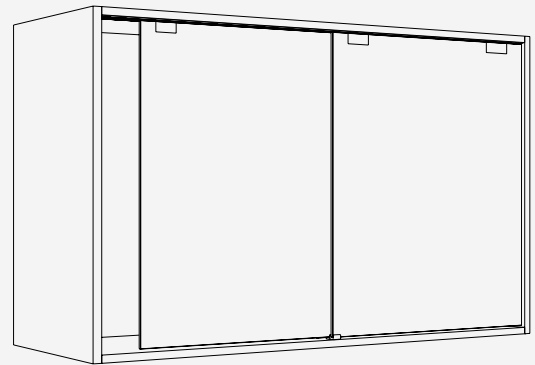
Fitting for 2 top-running glass doors up to 16 kg (35 lbs.), with screwed on or groove mounted running track. With soft and self closing mechanism. Design Inside.

Product highlights

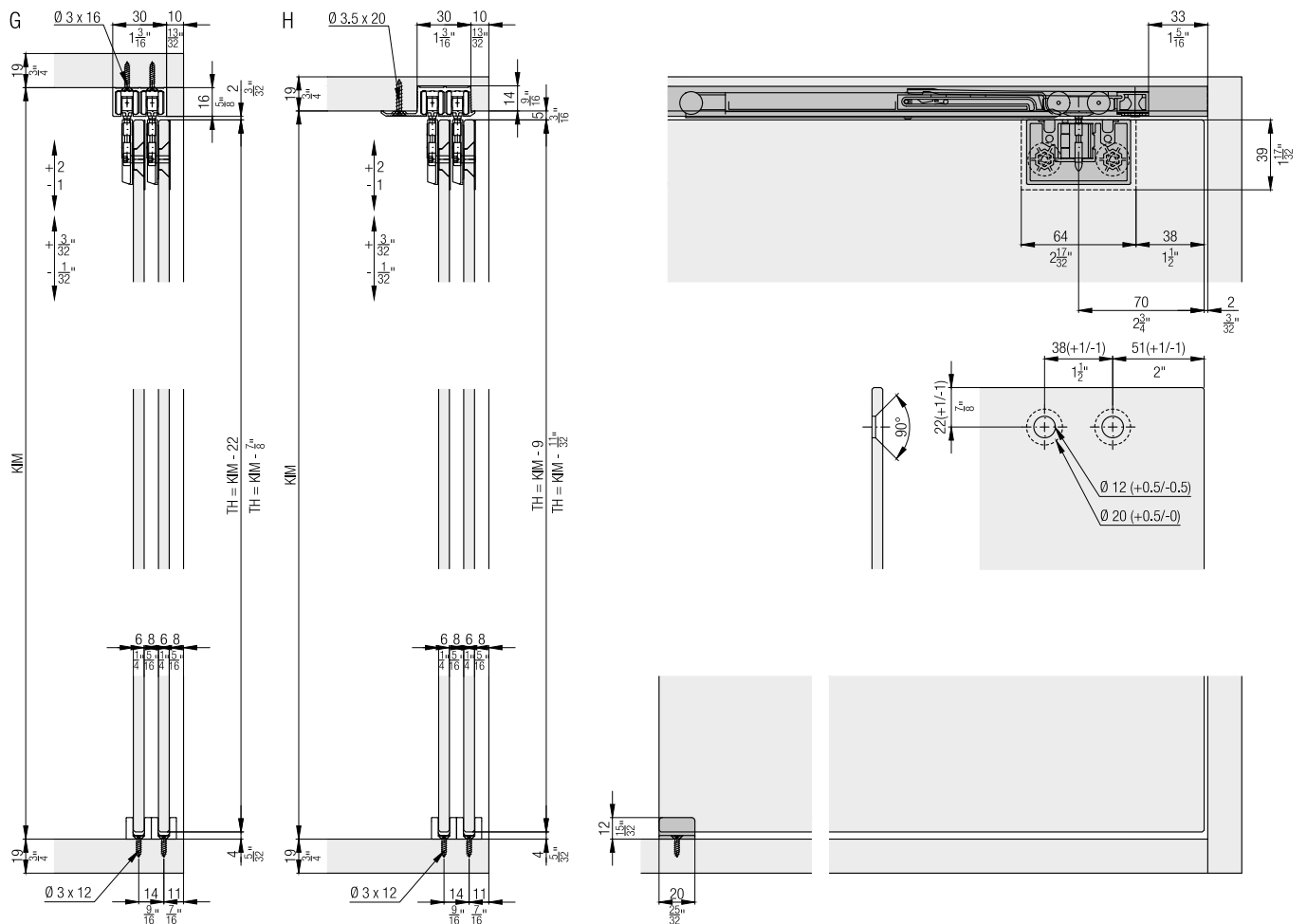
-  **Comfort** Smooth, silent running with Comfort Roller and soft and self closing system for different door weights
-  **Productivity** No groove in the base and invisible technology

Technical specifications

-  Max. 16 kg (35 lbs.)
-  Max. 1400 mm (4'7 1/8")
-  Max. 1000 mm (3'3 3/8")
-  6-6.35 mm (1/4")




Installation examples



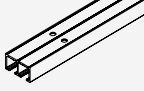
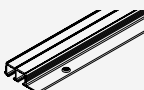
**Set for 2 glass doors up to 16 kg (35 lbs.),
with height adjustment**

	No.
Hawa Clipo 16 GS IS, for 2 doors	053.3314.071

Set consisting of:

		053.3314.071	No.
	Running gear	4	053.0297.171
	Hawa Clipo 16/Hawa Regal 16 C stopper, plastic, gray	2	053.3215.071
	Fixing plate, for screw fixing, zinc diecast	4	053.3311.072
	Spacer, plastics	8	053.3312.071
	Button head socket screws, M4x8 (5/32"x5/16"), steel, zinc-plated	8	600.0000.677
	Panel	4	053.3319.171
	Door follower, plastic, grey	1	053.3075.071
	Socket button head screw, M3x6 mm (1/8"x 1/4"), steel, zinc-plated	1	600.0000.679
	Hex jam nut M3, steel, zinc-plated	1	600.0000.680
	Bottom guide, plastic, grey	2	053.3253.001
	Flat countersunk head chipboard screw, 3x12 mm (1/8"x15/32"), steel, zinc-plated	2	766.5030.112

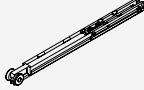


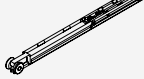
Running tracks

		mm (inch)	No.
	G: Double running track, for screw fixing, aluminum, anodized	2,500 (8' 2 7/16")	053.3247.250
		3,500 (11' 5 25/32")	053.3247.350
		6,000 (19' 8 7/32")	053.3247.600
	H: Double running track, aluminum, pre-drilled	2,500 (8' 2 7/16")	053.3248.250
		3,500 (11' 5 25/32")	053.3248.350
		6,000 (19' 8 7/32")	053.3248.600




Soft close up to 8/16 kg (17/35 lbs.)

	No.
Soft close Hawa Clipo 16/Hawa Regal C 16, up to 8 kg (17 lbs.)	053.3332.071
Soft close Hawa Clipo 16/Hawa Regal C 16, up to 16 kg (35 lbs.)	053.3332.072


Set consisting of:

		053.3332.071	053.3332.072	No.
	Damper, up to 8 kg (17 lbs.)	2		053.3330.071
	Trigger, with stopper	2	2	053.3331.071
	Cross recessed pan head screw, 2.2x8 mm (3/32"x5/16"), steel, zinc-plated	2	2	600.0000.482
	Damper, up to 16 kg (35 lbs.)		2	053.3330.072

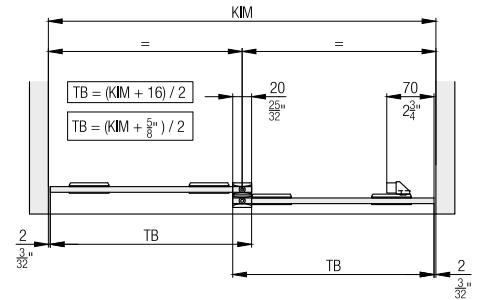
Handles

		No.
	Handle, for glue fixing, 64 mm (2 17/32"), plastic, chrome-plated, matt, 2-piece set	053.3323.971
	Finger-pull-handle, for glue fixing, 30 mm (1 3/16"), aluminum, anodized, 2-piece set	053.3091.982
	Finger-pull-handle, for glue fixing, 30 mm (1 3/16"), aluminum, anodized, 50-piece set	053.3091.983
	Finger-pull-handle, for glue fixing, 40 mm (1 9/16"), aluminum, anodized	053.3158.901

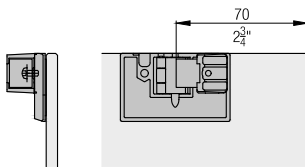
Accessories

		No.
	Track cleaner, plastic, red	040.3142.071

Calculations



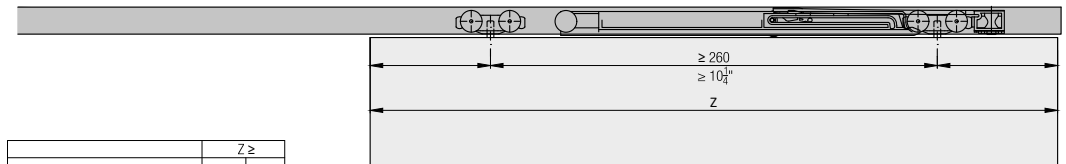
Door follower



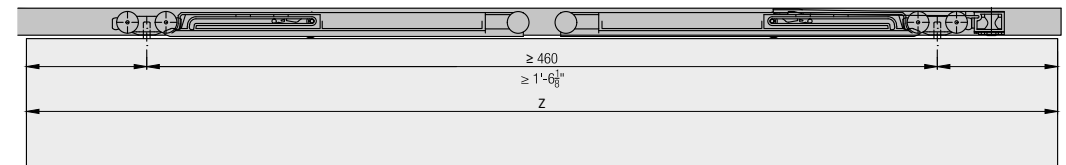
Soft close



	Z ≥	
	1	2
Hawa Clipo 16 H IS	1' 3 ³ / ₄ "	1' 11 ⁵ / ₈ "
Hawa Clipo 16 H MS	1' 5 ¹ / ₄ "	2' 1 ¹ / ₈ "
Hawa Clipo 16 H FS	1' 5 ¹ / ₄ "	2' 1 ¹ / ₈ "
Hawa Clipo 16 HM IS	1' 3 ³ / ₄ "	1' 11 ⁵ / ₈ "
Hawa Clipo 16 GK IS	1' 3 ³ / ₄ "	1' 11 ⁵ / ₈ "
Hawa Clipo 16 GS IS	1' 3 ³ / ₄ "	1' 11 ⁵ / ₈ "
Hawa Clipo 16 GPK IS	1' 3 ³ / ₄ "	1' 11 ⁵ / ₈ "
Hawa Clipo 16 GPPK IS	1' 3 ³ / ₄ "	1' 11 ⁵ / ₈ "



	Z ≥	
	1	2
Hawa Clipo 16 H IS	400	600
Hawa Clipo 16 H MS	438	638
Hawa Clipo 16 H FS	438	638
Hawa Clipo 16 HM IS	400	600
Hawa Clipo 16 GK IS	400	600
Hawa Clipo 16 GS IS	400	600
Hawa Clipo 16 GPK IS	400	600
Hawa Clipo 16 GPPK IS	400	600



Accessories

– Glass recommendations from page 249


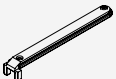


Planning/execution

Further information about the product can be found on www.hawa.com.


Set for 2 glass doors up to 16 kg (35 lbs.), with height adjustment

	No.
Hawa Clipo 16 GPK IS, for 2 doors	053.3264.071

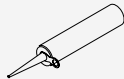
Set consisting of:

		053.3264.071	No.
	Running gear Hawa Clipo 16, with support and screw	4	053.3224.071
	Hawa Clipo 16/Hawa Regal 16 C stopper, plastic, gray	2	053.3215.071
	Housing, plastic, anthracite	4	053.3252.071
	Door follower, plastic, grey	1	053.3075.071
	Pan head thread forming screw, M3x6 mm (1/8"x1/4"), steel, zinc-plated	1	600.0000.488
	Bottom guide, plastic, grey	2	053.3253.001
	Flat countersunk head chipboard screw, 3x12 mm (1/8"x15/32"), steel, zinc-plated	2	766.5030.112

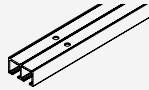
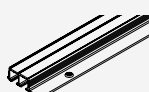
Suspension and glass retaining profiles

	mm (inch)	No.
	2,500 (8' 2 7/16")	053.3250.250
	3,500 (11' 5 25/32")	053.3250.350
	6,000 (19' 8 7/32")	053.3250.600

Adhesive

	No.
	Glue Ceresit 3B Silicone, 310 ml 098.0027.000

Running tracks

		mm (inch)	No.
	G: Double running track, for screw fixing, aluminum, anodized	2,500 (8' 2 7/16")	053.3247.250
		3,500 (11' 5 25/32")	053.3247.350
		6,000 (19' 8 7/32")	053.3247.600
	H: Double running track, aluminum, pre-drilled	2,500 (8' 2 7/16")	053.3248.250
		3,500 (11' 5 25/32")	053.3248.350
		6,000 (19' 8 7/32")	053.3248.600




Soft close up to 8/16 kg (17/35 lbs.)

	No.
Soft close Hawa Clipo 16/Hawa Regal C 16, up to 8 kg (17 lbs.)	053.3332.071
Soft close Hawa Clipo 16/Hawa Regal C 16, up to 16 kg (35 lbs.)	053.3332.072


Set consisting of:

		053.3332.071	053.3332.072	No.
	Damper, up to 8 kg (17 lbs.)	2		053.3330.071
	Trigger, with stopper	2	2	053.3331.071
	Cross recessed pan head screw, 2.2x8 mm (3/32"x5/16"), steel, zinc-plated	2	2	600.0000.482
	Damper, up to 16 kg (35 lbs.)		2	053.3330.072

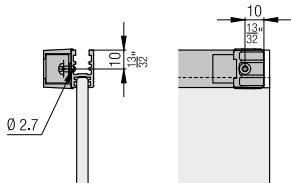
Handles

	No.
	Handle, for glue fixing, 64 mm (2 17/32"), plastic, chrome-plated, matt, 2-piece set 053.3323.971
	Finger-pull-handle, for glue fixing, 30 mm (1 3/16"), aluminum, anodized, 2-piece set 053.3091.982
	Finger-pull-handle, for glue fixing, 30 mm (1 3/16"), aluminum, anodized, 50-piece set 053.3091.983
	Finger-pull-handle, for glue fixing, 40 mm (1 9/16"), aluminum, anodized 053.3158.901

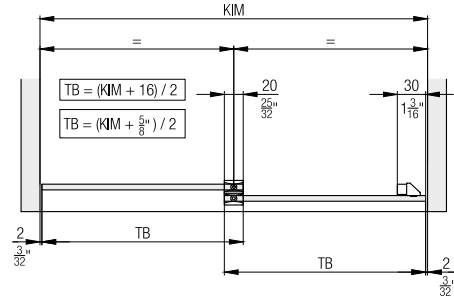
Accessories

		No.
	Track cleaner, plastic, red	040.3142.071


Door follower

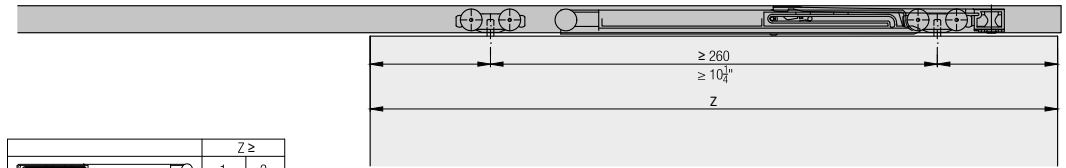



Calculations

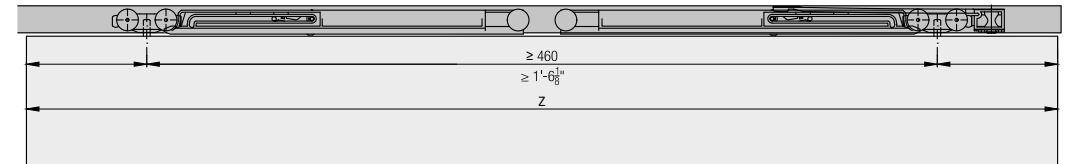


Soft close

	Z ≥	
	1	2
		
Hawa Clipo 16 H IS	1' 3 ³ / ₄ "	1' 11 ⁵ / ₈ "
Hawa Clipo 16 H MS	1' 5 ¹ / ₄ "	2' 1 ¹ / ₈ "
Hawa Clipo 16 H FS	1' 5 ¹ / ₄ "	2' 1 ¹ / ₈ "
Hawa Clipo 16 HM IS	1' 3 ³ / ₄ "	1' 11 ⁵ / ₈ "
Hawa Clipo 16 GK IS	1' 3 ³ / ₄ "	1' 11 ⁵ / ₈ "
Hawa Clipo 16 GS IS	1' 3 ³ / ₄ "	1' 11 ⁵ / ₈ "
Hawa Clipo 16 GPK IS	1' 3 ³ / ₄ "	1' 11 ⁵ / ₈ "
Hawa Clipo 16 GPPK IS	1' 3 ³ / ₄ "	1' 11 ⁵ / ₈ "



	Z ≥	
	1	2
		
Hawa Clipo 16 H IS	400	600
Hawa Clipo 16 H MS	438	638
Hawa Clipo 16 H FS	438	638
Hawa Clipo 16 HM IS	400	600
Hawa Clipo 16 GK IS	400	600
Hawa Clipo 16 GS IS	400	600
Hawa Clipo 16 GPK IS	400	600
Hawa Clipo 16 GPPK IS	400	600



Accessories

– Glass recommendations from page 249

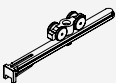

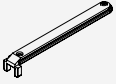





Planning/execution

Further information about the product can be found on www.hawa.com.


Set for 2 glass doors up to 16 kg (35 lbs.), with height adjustment

		No.
Hawa Clipo 16 GPPK IS, for 2 doors		053.3265.071

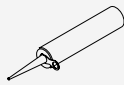
Set consisting of:

		053.3265.071		No.
	Running gear Hawa Clipo 16, with support and screw	4	053.3224.071	
	Hawa Clipo 16/Hawa Regal 16 C stopper, plastic, gray	2	053.3215.071	
	Housing, plastic, anthracite	4	053.3252.071	
	Door follower, plastic, grey	1	053.3075.071	
	Pan head thread forming screw, M3x6 mm (1/8"x1/4"), steel, zinc-plated	1	600.0000.488	
	End cover, plastique, grey	4	053.3255.071	
	Bottom guide, plastic grey	2	053.3254.001	
	Pan-Head chipboard screw, 3x20 mm (1/8"x25/32"), steel, zinc-plated	2	766.5030.117	


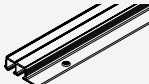
Suspension and glass retaining profiles

		mm (inch)	No.
	Glass fixing profile, for glue fixing, aluminum, anodized	2,500 (8' 2 7/16")	053.3250.250
		3,500 (11' 5 25/32")	053.3250.350
		6,000 (19' 8 7/32")	053.3250.600

Adhesive

		No.
	Glue Ceresit 3B Silicone, 310 ml	098.0027.000

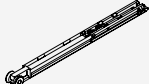
Running tracks

		mm (inch)	No.
	G: Double running track, for screw fixing, aluminum, anodized	2,500 (8' 2 7/16")	053.3247.250
		3,500 (11' 5 25/32")	053.3247.350
		6,000 (19' 8 7/32")	053.3247.600
	H: Double running track, aluminum, pre-drilled	2,500 (8' 2 7/16")	053.3248.250
		3,500 (11' 5 25/32")	053.3248.350
		6,000 (19' 8 7/32")	053.3248.600




Soft close up to 8/16 kg (17/35 lbs.)

		No.
Soft close Hawa Clipo 16/Hawa Regal C 16, up to 8 kg (17 lbs.)		053.3332.071
Soft close Hawa Clipo 16/Hawa Regal C 16, up to 16 kg (35 lbs.)		053.3332.072


Set consisting of:

		053.3332.071	053.3332.072	No.
	Damper, up to 8 kg (17 lbs.)	2		053.3330.071
	Trigger, with stopper	2	2	053.3331.071
	Cross recessed pan head screw, 2.2x8 mm (3/32"x5/16"), steel, zinc-plated	2	2	600.0000.482
	Damper, up to 16 kg (35 lbs.)		2	053.3330.072

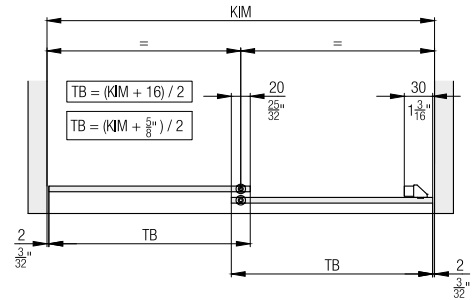
Handles

		No.
	Handle, for glue fixing, 64 mm (2 17/32"), plastic, chrome-plated, matt, 2-piece set	053.3323.971
	Finger-pull-handle, for glue fixing, 30 mm (1 3/16"), aluminum, anodized, 2-piece set	053.3091.982
	Finger-pull-handle, for glue fixing, 30 mm (1 3/16"), aluminum, anodized, 50-piece set	053.3091.983
	Finger-pull-handle, for glue fixing, 40 mm (1 9/16"), aluminum, anodized	053.3158.901

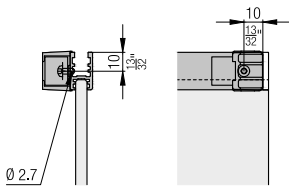
Accessories

		No.
	Track cleaner, plastic, red	040.3142.071

Calculations

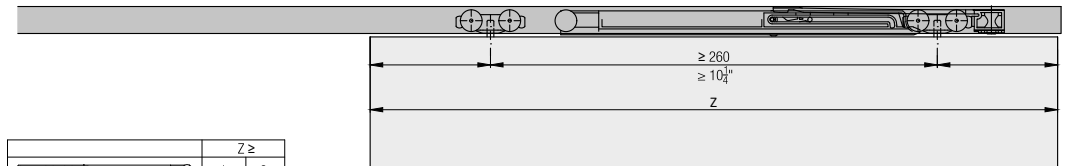


Door follower

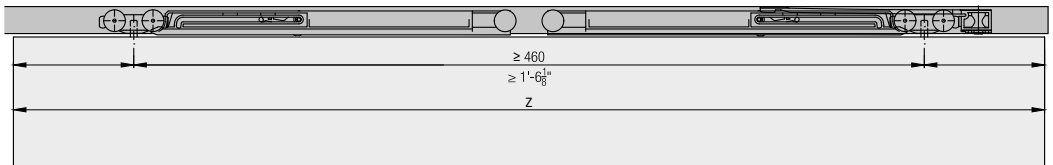


Soft close

	Z ≥	
	1	2
Hawa Clipo 16 H IS	1' 3 ³ / ₄ "	1' 11 ⁵ / ₈ "
Hawa Clipo 16 H MS	1' 5 ¹ / ₄ "	2' 1 ¹ / ₈ "
Hawa Clipo 16 H FS	1' 5 ¹ / ₄ "	2' 1 ¹ / ₈ "
Hawa Clipo 16 HM IS	1' 3 ³ / ₄ "	1' 11 ⁵ / ₈ "
Hawa Clipo 16 GK IS	1' 3 ³ / ₄ "	1' 11 ⁵ / ₈ "
Hawa Clipo 16 GS IS	1' 3 ³ / ₄ "	1' 11 ⁵ / ₈ "
Hawa Clipo 16 GPK IS	1' 3 ³ / ₄ "	1' 11 ⁵ / ₈ "
Hawa Clipo 16 GPPK IS	1' 3 ³ / ₄ "	1' 11 ⁵ / ₈ "



	Z ≥	
	1	2
Hawa Clipo 16 H IS	400	600
Hawa Clipo 16 H MS	438	638
Hawa Clipo 16 H FS	438	638
Hawa Clipo 16 HM IS	400	600
Hawa Clipo 16 GK IS	400	600
Hawa Clipo 16 GS IS	400	600
Hawa Clipo 16 GPK IS	400	600
Hawa Clipo 16 GPPK IS	400	600



Accessories

– Glass recommendations from page 249

Planning/execution

Further information about the product can be found on www.hawa.com.

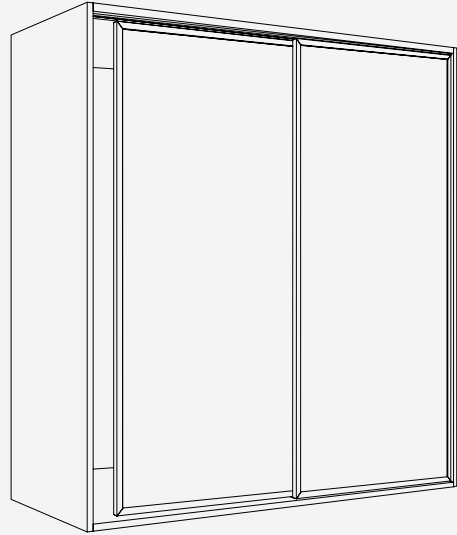
Fitting for 2 top-running glass doors with aluminum frame up to 26 kg (57 lbs.), with groove mounted running track. With soft and self closing mechanism. Design Inside.

Product highlights

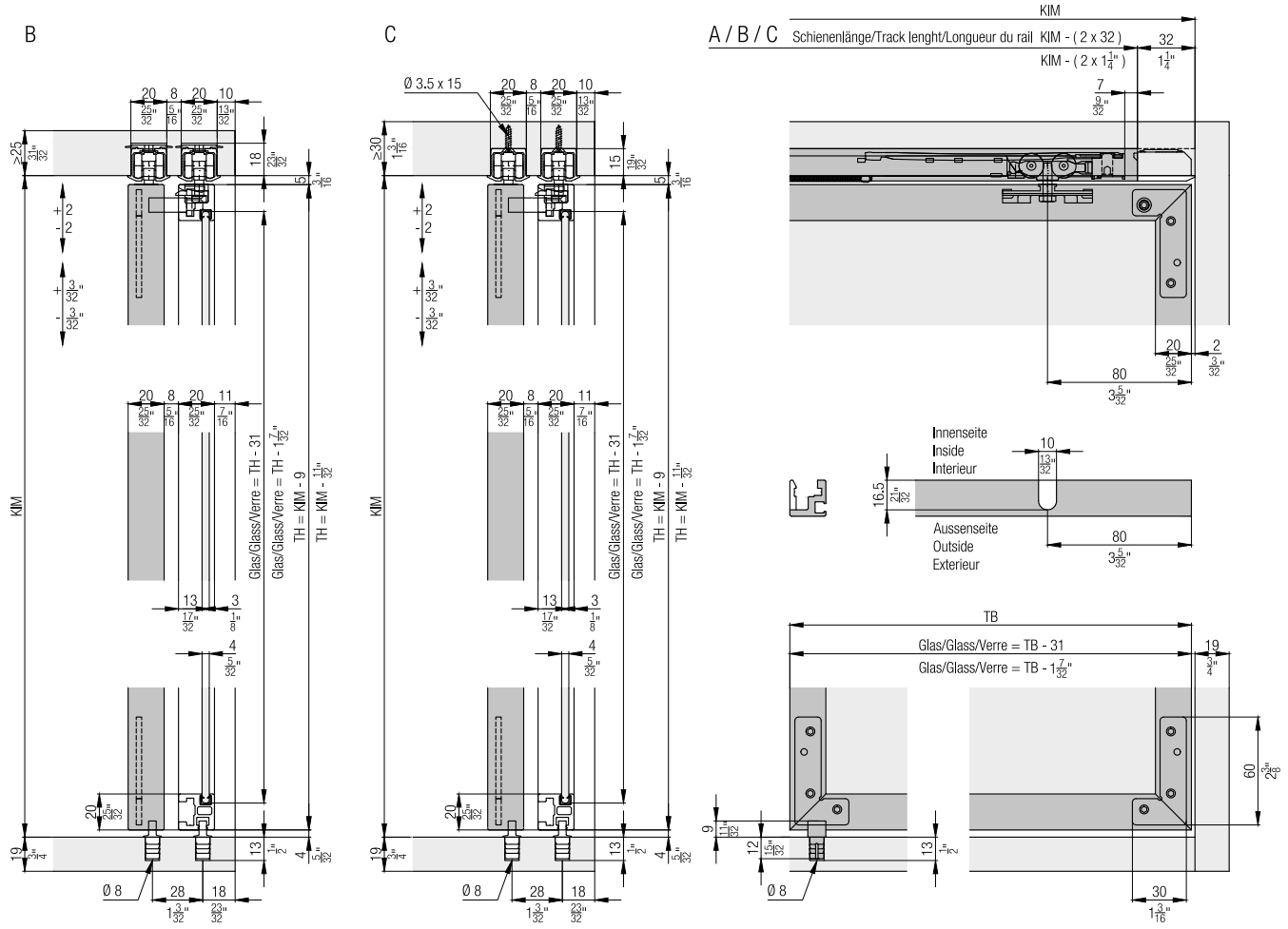
- Comfort** Quiet, smooth running and soft and self closing system for different door weights
- Productivity** No groove in the base and invisible technology

Technical specifications

- Max. 26 kg (57 lbs.)
- Max. 2000 mm (6'6 3/4")
- Max. 800 mm (2'7 15/32")
- 4 mm (5/32)
Frame: 20 mm (25/32")









Installation examples



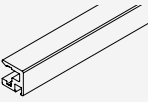
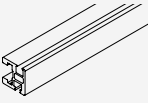

Set for 2 glass doors up to 26 kg (57 lbs.), with height adjustment

	No.
Hawa Clipo 26 GR IS, for 2 doors	053.3360.071

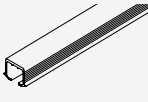
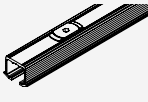
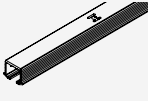
Set consisting of:

		053.3360.071	No.
	Running gear	4	053.3345.071
	Stopper, plastic, gray	4	057.3148.071
	Corner connector left, steel, zinc-plated	4	040.3054.171
	Corner connector right, steel, zinc-plated	4	040.3054.172
	Door follower	1	053.3350.071
	Hawa Clipo 16 H bottom guide, plastic, anthracite	2	053.3214.001

Glass frame profiles




		mm (inch)	No.
	Glass frame profile, above/lateral, aluminum, anodized	2,500 (8' 2 7/16")	040.3045.250
		3,500 (11' 5 25/32")	040.3045.350
		6,000 (19' 8 7/32")	040.3045.600
	Glass frame profile, bottom, aluminum, anodized	2,500 (8' 2 7/16")	040.3046.250
		3,500 (11' 5 25/32")	040.3046.350
		6,000 (19' 8 7/32")	040.3046.600
	Sealing profile, plastic, gray	2,500 (8' 2 7/16")	040.3061.250

Running tracks

		mm (inch)	No.
	A: Single running track, for glue fixing, aluminum, anodized	2,500 (8' 2 7/16")	053.3324.250
		3,500 (11' 5 25/32")	053.3324.350
		6,000 (19' 8 7/32")	053.3324.600
	B: Single running track, swivel lug, aluminum, anodized (not for hard wood/MDF)	2,500 (8' 2 7/16")	053.3327.250
		3,500 (11' 5 25/32")	053.3327.350
		6,000 (19' 8 7/32")	053.3327.600
	C: Single running track, for screw fixing, aluminum, anodized	2,500 (8' 2 7/16")	053.3325.250
		3,500 (11' 5 25/32")	053.3325.350
		6,000 (19' 8 7/32")	053.3325.600

Track end piece set for single running tracks

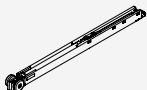


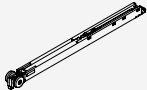
	No.
Track-end section, for screw fixing, plastic, gray, 2-piece set	053.3354.071
Track-end section, swivel lug, plastic, gray, 2-piece set	053.3355.051

		053.3354.071	053.3355.051	No.
Set consisting of:				
	Track-end piece, for screw fixing, plastic	2		053.0334.001
	Chipboard screw, 4x12 mm (5/32"x15/32"), steel, zinc-plated	2		600.0000.704
	Track-end piece, with swivel lug, plastic		2	053.3351.071




Soft close up to 15/26 kg (33/57 lbs.)

	No.
Soft close, up to 15 kg (33 lbs.)	057.3159.071
Soft close, up to 26 kg (57 lbs.)	057.3159.072



Set consisting of:

		057.3159.071	057.3159.072	No.
	Soft close, up to 15 kg (33 lbs.)	2		057.3156.071
	Release piece soft close	2	2	057.0182.101
	Thread rolling rounded head screw, M2.5x5 mm (3/32"x3/16"), steel, zinc-plated	2	2	600.0000.764
	Soft close, up to 26 kg (57 lbs.)		2	057.3156.072

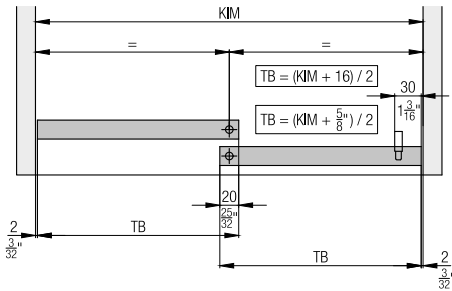
Handles

		No.
	Handle, for glue fixing, 64 mm (2 17/32"), plastic, chrome-plated, matt, 2-piece set	053.3323.971
	Finger-pull-handle, for glue fixing, 30 mm (1 3/16"), aluminum, anodized, 2-piece set	053.3091.982
	Finger-pull-handle, for glue fixing, 30 mm (1 3/16"), aluminum, anodized, 50-piece set	053.3091.983
	Finger-pull-handle, for glue fixing, 40 mm (1 9/16"), aluminum, anodized	053.3158.901

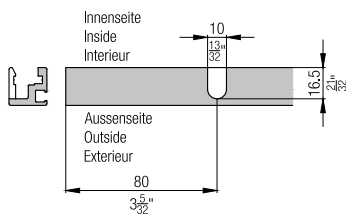
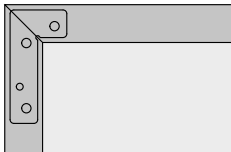
Accessories

		No.
	Milling template Hawa Clipo 26 GR/Hawa Regal C 26 GR	040.3160.071
	Track cleaner, plastic, red	040.3142.071

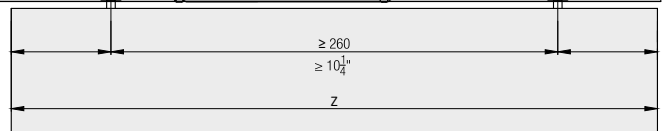
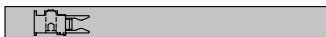
Calculations



Frame processing

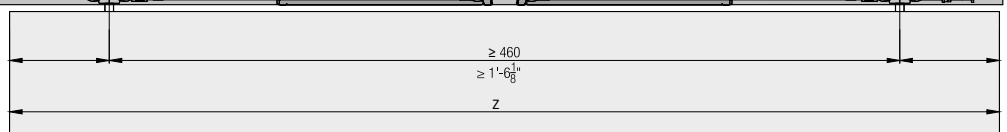


Soft close



	Z ≥	
	1	2
Hawa Porta 40 H	1' 4 17/32	2' 0 13/32
Hawa Porta 40 GE	1' 2 13/16	1' 10 11/16
Hawa Clipo 26 H IS	1' 4 17/32	2' 0 13/32
Hawa Clipo 26 H MS	1' 6 1/32	2' 1 29/32
Hawa Clipo 36 H IS	1' 4 17/32	2' 0 13/32
Hawa Clipo 36 H MS	1' 6 1/32	2' 1 29/32
Hawa Clipo 36 HM IS	1' 4 17/32	2' 0 13/32
Hawa Clipo 26 GR IS	1' 4 17/32	2' 0 13/32
Hawa Clipo 36 G IS	1' 4 17/32	2' 0 13/32
Hawa Clipo 36 GPK IS	1' 4 17/32	2' 0 13/32
Hawa Clipo 36 GPPK IS	1' 4 17/32	2' 0 13/32
Hawa Regal C 26 HM IS	1' 4 17/32	2' 0 13/32
Hawa Regal C 26 GR IS	1' 3 3/4	1' 11 5/8

	Z ≥	
	1	2
Hawa Porta 40 H	420	620
Hawa Porta 40 GE	376	576
Hawa Clipo 26 H IS	420	620
Hawa Clipo 26 H MS	458	658
Hawa Clipo 36 H IS	420	620
Hawa Clipo 36 H MS	458	658
Hawa Clipo 36 HM IS	420	620
Hawa Clipo 26 GR IS	420	620
Hawa Clipo 36 G IS	420	620
Hawa Clipo 36 GPK IS	420	620
Hawa Clipo 36 GPPK IS	420	620
Hawa Regal C 26 HM IS	420	620
Hawa Regal C 26 GR IS	400	600



Accessories

– Glass recommendations from page 249

Planning/execution

Further information about the product can be found on www.hawa.com.

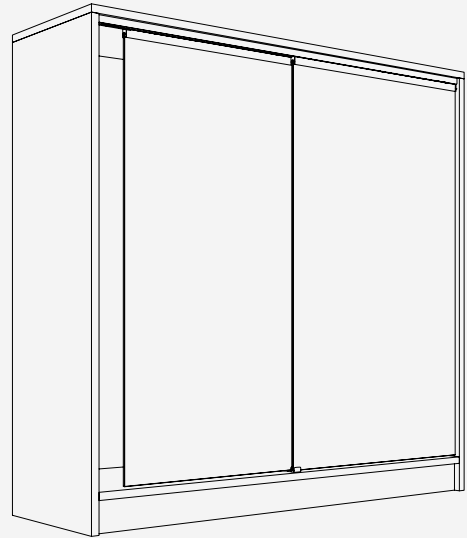
Fitting for 1-2 top-running glass doors up to 36 kg (79 lbs.), with screwed on or groove mounted running track. With soft and self closing mechanism. Design Inside.

Product highlights

- Comfort** Quiet, smooth running and soft and self closing system for different door weights
- Productivity** Easy installation with tool-less clip-on system and convenient height adjustment

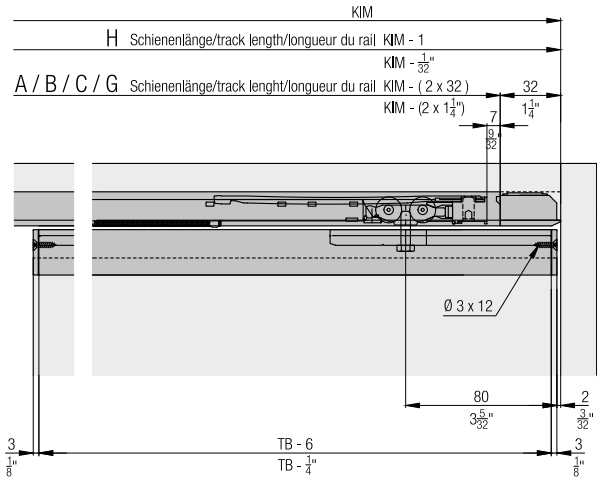
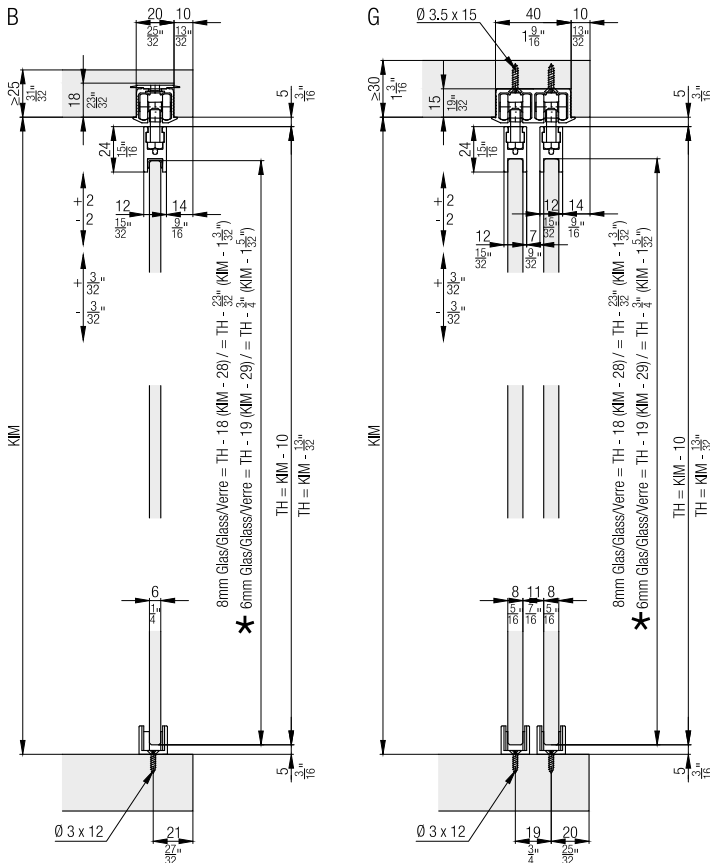
Technical specifications

- Max. 36 kg (79 lbs.)
- Max. 2000 mm (6'6 3/4")
- Max. 1000 mm (3'3 3/8")
- 6-8 mm (1/4" to 5/16")



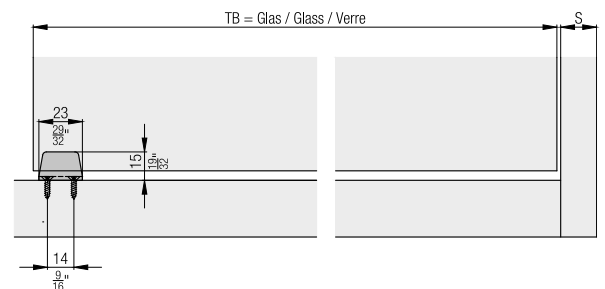
Installation examples

★ Zentrierhilfe für 6mm Glas
Centering help for 6mm glass
Aide de centrage pour verre 6mm



Klebstoff-Empfehlungen für Glas:
 Recommended adhesive for glass:
 Colle recommandée pour verre:



- CERESIT 3B Silikon
- 3M Scotch Weld DP
- Ergo, 6520



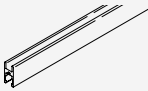
Set for 1 glass door up to 36 kg (79 lbs.), with height adjustment

	No.
Hawa Clipo 36 GPK, for 1 door	053.3361.071

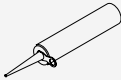
Set consisting of:

		053.3361.071	No.
	Running gear	2	053.3344.071
	Flat countersunk head chipboard screw, 3x12 mm (1/8" x 15/32"), steel, zinc-plated, black	2	600.0000.703
	Stopper, plastic, gray	2	057.3148.071
	Centring help, for 6 mm (1/4") glass	2	053.3139.001
	Bottom guide glass, playfree, chrome-plated, matt	1	053.3097.901
	Slider bottom guide, plastic, grey, 4-piece set	1	053.0146.001
	Flat countersunk head chipboard screw, 3x12 mm (1/8" x 15/32"), steel, zinc-plated	2	766.5030.112

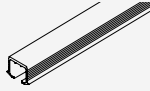
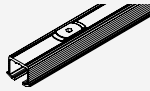
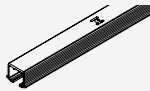
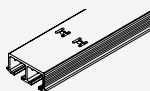
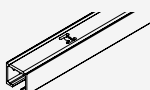
Suspension and glass retaining profiles

		mm (inch)	No.
	Glass fixing profile, aluminum, anodized	2,500 (8' 2 7/16")	053.3072.250
		3,500 (11' 5 25/32")	053.3072.350
		6,000 (19' 8 7/32")	053.3072.600

Adhesive

	No.
	Glue Ceresit 3B Silicone, 310 ml
	098.0027.000




Running tracks

		mm (inch)	No.	
	A: Single running track, for glue fixing, aluminum, anodized	2,500 (8' 2 7/16")	053.3324.250	
		3,500 (11' 5 25/32")	053.3324.350	
		6,000 (19' 8 7/32")	053.3324.600	
	B: Single running track, swivel lug, aluminum, anodized (not for hard wood/ MDF)	2,500 (8' 2 7/16")	053.3327.250	
		3,500 (11' 5 25/32")	053.3327.350	
		6,000 (19' 8 7/32")	053.3327.600	
	C: Single running track, for screw fixing, aluminum, anodized	2,500 (8' 2 7/16")	053.3325.250	
		3,500 (11' 5 25/32")	053.3325.350	
		6,000 (19' 8 7/32")	053.3325.600	
	G: Double running track, for screw fixing, aluminum, anodized	2,500 (8' 2 7/16")	053.3342.250	
		D: Double running track, for screw fixing, aluminum, anodized	3,500 (11' 5 25/32")	053.3342.350
			6,000 (19' 8 7/32")	053.3342.600
	H: Single running track, for screw fixing, aluminum, anodized	2,500 (8' 2 7/16")	053.3326.250	
		3,500 (11' 5 25/32")	053.3326.350	
		6,000 (19' 8 7/32")	053.3326.600	

Track end piece set for single running tracks

	No.
Track-end section, for screw fixing, plastic, gray, 2-piece set	053.3354.071
Track-end section, swivel lug, plastic, gray, 2-piece set	053.3355.051




Set consisting of:

	053.3354.071	053.3355.051	No.
 Track-end piece, for screw fixing, plastic	2		053.0334.001
 Chipboard screw, 4x12 mm (5/32"x15/32"), steel, zinc-plated	2		600.0000.704
 Track-end piece, with swivel lug, plastic		2	053.3351.071

Track end piece set for double running tracks

	No.
Track-end section, double track, swivel lug, plastic, gray, 2-piece set	053.3362.051
Track-end section, double track, plastic, grey, 2-piece set	053.3365.071

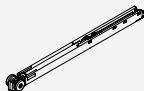


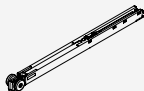
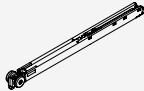
Set consisting of:

	053.3362.051	053.3365.071	No.
 Track-end piece, double running track, with swivel lug, plastic	2		053.3352.071
 Track-end piece, Double running track, for screw fixing, plastic		2	053.0335.001
 Chipboard screw, 4x12 mm (5/32"x15/32"), steel, zinc-plated		4	600.0000.704





Soft close up to 15/26/36 kg (33/57/79 lbs.)

	No.
Soft close, up to 15 kg (33 lbs.)	057.3159.071
Soft close, up to 26 kg (57 lbs.)	057.3159.072
Soft close, up to 40 kg (88 lbs.)	057.3159.073


Set consisting of:

	057.3159.071	057.3159.072	057.3159.073	No.
 Soft close, up to 15 kg (33 lbs.)	2			057.3156.071
 Release piece soft close	2	2	2	057.0182.101
 Thread rolling rounded head screw, M2.5x5 mm (3/32"x3/16"), steel, zinc-plated	2	2	2	600.0000.764
 Soft close, up to 26 kg (57 lbs.)		2		057.3156.072
 Soft close, up to 40 kg (88 lbs.)			2	057.3156.073

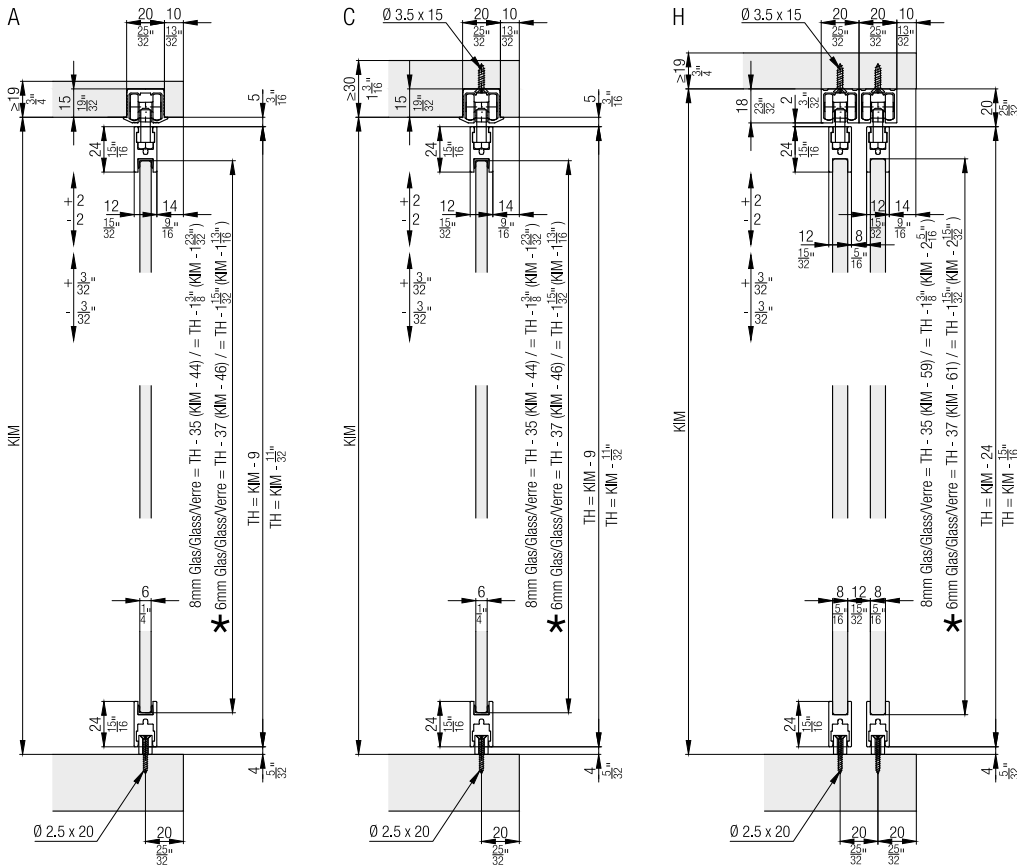
Handles

	No.
 Handle, for glue fixing, 64 mm (2 17/32"), plastic, chrome-plated, matt, 2-piece set	053.3323.971
 Finger-pull-handle, for glue fixing, 30 mm (1 3/16"), aluminum, anodized, 2-piece set	053.3091.982
 Finger-pull-handle, for glue fixing, 30 mm (1 3/16"), aluminum, anodized, 50-piece set	053.3091.983
 Finger-pull-handle, for glue fixing, 40 mm (1 9/16"), aluminum, anodized	053.3158.901

Accessories

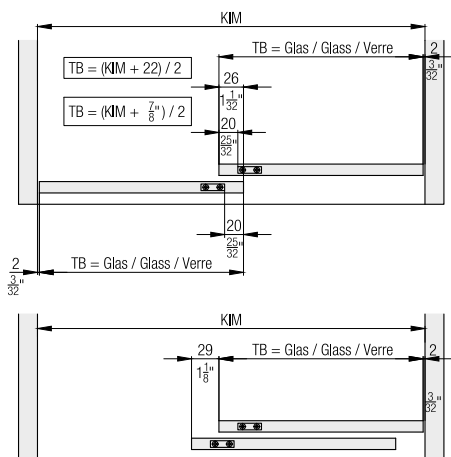
	No.
 Track cleaner, plastic, red	040.3142.071

Further installation examples



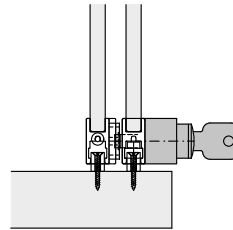
★ Zentrierhilfe für 6mm Glas
 Centering help for 6mm glass
 Aide de centrage pour verre 6mm

Calculations

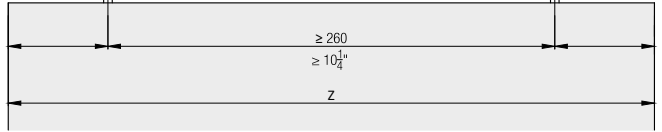


Locking systems

Details from page 242 onwards

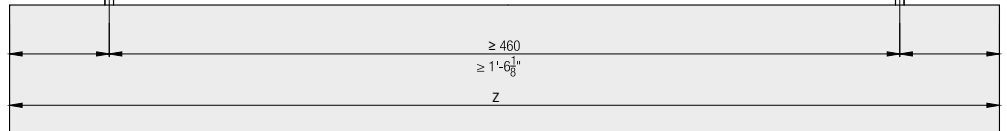


Soft close



	Z ≥	
	1	2
Hawa Porta 40 H	1' 4 ¹⁷ / ₃₂ "	2' 0 ¹³ / ₃₂ "
Hawa Porta 40 GE	1' 2 ¹³ / ₁₆ "	1' 10 ¹¹ / ₁₆ "
Hawa Clipo 26 H IS	1' 4 ¹⁷ / ₃₂ "	2' 0 ¹³ / ₃₂ "
Hawa Clipo 26 H MS	1' 6 ¹ / ₃₂ "	2' 1 ²⁹ / ₃₂ "
Hawa Clipo 36 H IS	1' 4 ¹⁷ / ₃₂ "	2' 0 ¹³ / ₃₂ "
Hawa Clipo 36 H MS	1' 6 ¹ / ₃₂ "	2' 1 ²⁹ / ₃₂ "
Hawa Clipo 36 HM IS	1' 4 ¹⁷ / ₃₂ "	2' 0 ¹³ / ₃₂ "
Hawa Clipo 26 GR IS	1' 4 ¹⁷ / ₃₂ "	2' 0 ¹³ / ₃₂ "
Hawa Clipo 36 G IS	1' 4 ¹⁷ / ₃₂ "	2' 0 ¹³ / ₃₂ "
Hawa Clipo 36 GPK IS	1' 4 ¹⁷ / ₃₂ "	2' 0 ¹³ / ₃₂ "
Hawa Clipo 36 GPPK IS	1' 4 ¹⁷ / ₃₂ "	2' 0 ¹³ / ₃₂ "
Hawa Regal C 26 HM IS	1' 4 ¹⁷ / ₃₂ "	2' 0 ¹³ / ₃₂ "
Hawa Regal C 26 GR IS	1' 3 ⁹ / ₈ "	1' 11 ⁵ / ₈ "

	Z ≥	
	1	2
Hawa Porta 40 H	420	620
Hawa Porta 40 GE	376	576
Hawa Clipo 26 H IS	420	620
Hawa Clipo 26 H MS	458	658
Hawa Clipo 36 H IS	420	620
Hawa Clipo 36 H MS	458	658
Hawa Clipo 36 HM IS	420	620
Hawa Clipo 26 GR IS	420	620
Hawa Clipo 36 G IS	420	620
Hawa Clipo 36 GPK IS	420	620
Hawa Clipo 36 GPPK IS	420	620
Hawa Regal C 26 HM IS	420	620
Hawa Regal C 26 GR IS	400	600



Accessories

- Locking systems from page 242
- Glass recommendations from page 249

Planning/execution

Further information about the product can be found on www.hawa.com.

Fitting for 2 top-running glass doors up to 36 kg (79 lbs.), with screwed on or groove mounted running track. With soft and self closing mechanism. Design Inside.

Product highlights



Comfort Quiet, smooth running and soft and self closing system for different door weights



Productivity No groove in the base and invisible technology

Technical specifications



Max. 36 kg (79 lbs.)



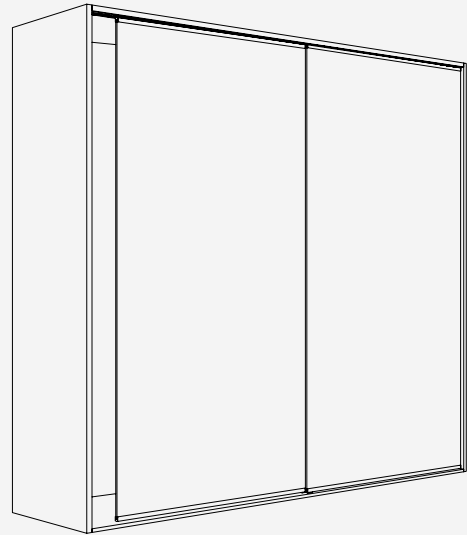
Max. 2000 mm (6'6 3/4")



Max. 1000 mm (3'3 3/8")

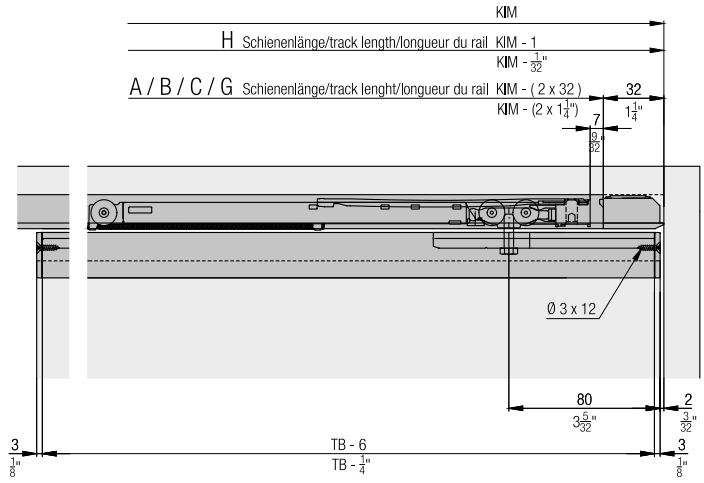
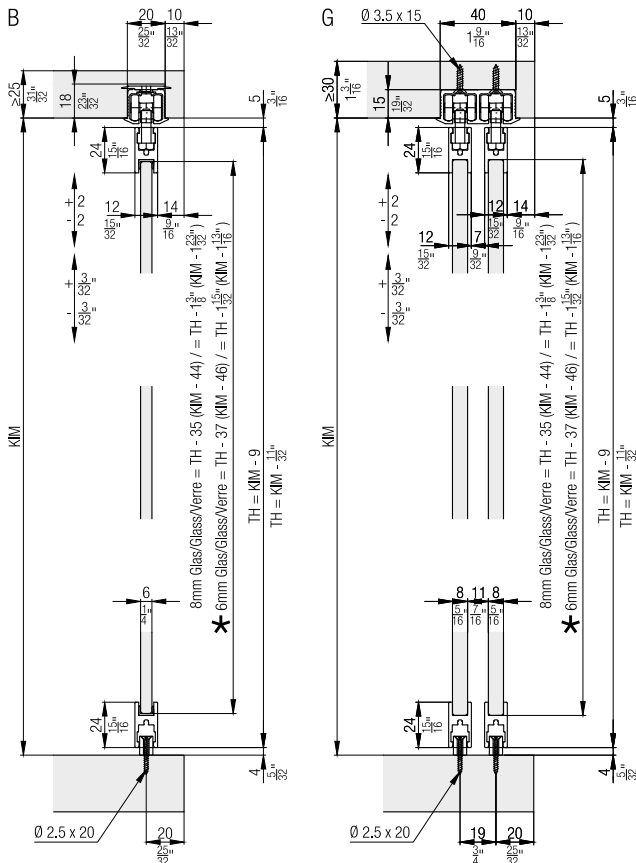


6-8 mm (1/4" to 5/16")

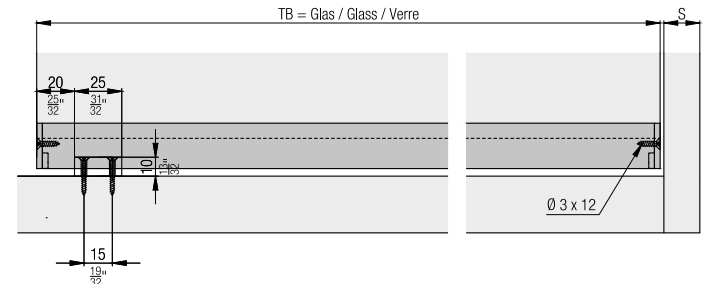


Installation examples

- ★ Zentrierhilfe für 6mm Glas
Centering help for 6mm glass
Aide de centrage pour verre 6mm



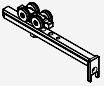






- Klebstoff-Empfehlungen für Glas:**
 Recommended adhesive for glass:
 Colle recommandée pour verre:
- CERESIT 3B Silikon
 - 3M Scotch Weld DP
 - Ergo, 6520



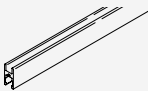
**Set for 1 glass door up to 36 kg (79 lbs.),
with height adjustment**

	No.
Hawa Clipo 36 GPPK, for 1 door	053.3361.072

Set consisting of:

		053.3361.072	No.
	Running gear	2	053.3344.071
	Flat countersunk head chipboard screw, 3x12 mm (1/8" x 15/32"), steel, zinc-plated, black	5	600.0000.703
	Stopper, plastic, gray	2	057.3148.071
	Centring help, for 6 mm (1/4") glass	8	053.3139.001
	End cover	3	053.0329.001
	Bottom guide	1	053.0333.001
	Flat countersunk head chipboard screw 2.5x20 mm (1/8" x 25/32"), steel, zinc-plated	2	600.0000.705

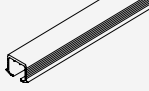
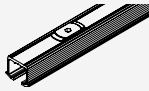
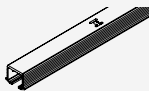
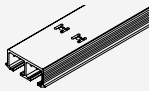
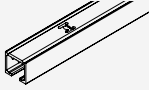
Suspension and glass retaining profiles

		mm (inch)	No.
	Glass fixing profile, aluminum, anodized	2,500 (8' 2 7/16")	053.3072.250
		3,500 (11' 5 25/32")	053.3072.350
		6,000 (19' 8 7/32")	053.3072.600

Adhesive

		No.
	Glue Ceresit 3B Silicone, 310 ml	098.0027.000




Running tracks

		mm (inch)	No.
	A: Single running track, for glue fixing, aluminum, anodized	2,500 (8' 2 7/16")	053.3324.250
		3,500 (11' 5 25/32")	053.3324.350
		6,000 (19' 8 7/32")	053.3324.600
	B: Single running track, swivel lug, aluminum, anodized (not for hard wood/ MDF)	2,500 (8' 2 7/16")	053.3327.250
		3,500 (11' 5 25/32")	053.3327.350
		6,000 (19' 8 7/32")	053.3327.600
	C: Single running track, for screw fixing, aluminum, anodized	2,500 (8' 2 7/16")	053.3325.250
		3,500 (11' 5 25/32")	053.3325.350
		6,000 (19' 8 7/32")	053.3325.600
	G: Double running track, for screw fixing, aluminum, anodized	2,500 (8' 2 7/16")	053.3342.250
		3,500 (11' 5 25/32")	053.3342.350
		6,000 (19' 8 7/32")	053.3342.600
	D: Double running track, for screw fixing, aluminum, anodized	2,500 (8' 2 7/16")	053.3326.250
		3,500 (11' 5 25/32")	053.3326.350
		6,000 (19' 8 7/32")	053.3326.600

Track end piece set for single running tracks

	No.
Track-end section, for screw fixing, plastic, gray, 2-piece set	053.3354.071
Track-end section, swivel lug, plastic, gray, 2-piece set	053.3355.051




Set consisting of:

	053.3354.071	053.3355.051	No.
 Track-end piece, for screw fixing, plastic	2		053.0334.001
 Chipboard screw, 4x12 mm (5/32"x15/32"), steel, zinc-plated	2		600.0000.704
 Track-end piece, with swivel lug, plastic		2	053.3351.071

Track end piece set for double running tracks

	No.
Track-end section, double track, swivel lug, plastic, gray, 2-piece set	053.3362.051
Track-end section, double track, plastic, grey, 2-piece set	053.3365.071

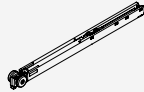


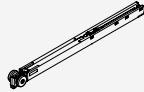
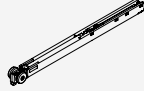
Set consisting of:

	053.3362.051	053.3365.071	No.
 Track-end piece, double running track, with swivel lug, plastic	2		053.3352.071
 Track-end piece, Double running track, for screw fixing, plastic		2	053.0335.001
 Chipboard screw, 4x12 mm (5/32"x15/32"), steel, zinc-plated		4	600.0000.704




Soft close up to 15/26/36 kg (33/57/79 lbs.)

	No.
Soft close, up to 15 kg (33 lbs.)	057.3159.071
Soft close, up to 26 kg (57 lbs.)	057.3159.072
Soft close, up to 40 kg (88 lbs.)	057.3159.073


Set consisting of:

	057.3159.071	057.3159.072	057.3159.073	No.
 Soft close, up to 15 kg (33 lbs.)	2			057.3156.071
 Release piece soft close	2	2	2	057.0182.101
 Thread rolling rounded head screw, M2.5x5 mm (3/32"x3/16"), steel, zinc-plated	2	2	2	600.0000.764
 Soft close, up to 26 kg (57 lbs.)		2		057.3156.072
 Soft close, up to 40 kg (88 lbs.)			2	057.3156.073

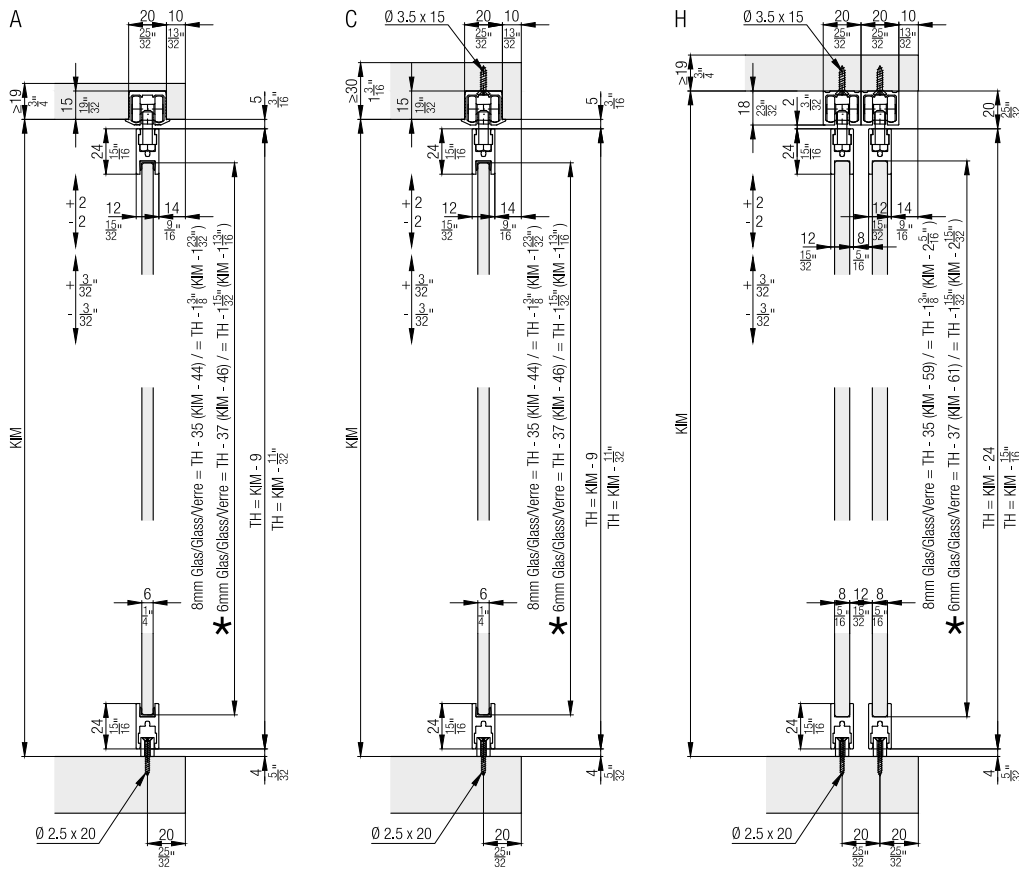
Handles

	No.	
 Handle, for glue fixing, 64 mm (2 17/32"), plastic, chrome-plated, matt, 2-piece set	053.3323.971	
	Finger-pull-handle, for glue fixing, 30 mm (1 3/16"), aluminum, anodized, 2-piece set	053.3091.982
	Finger-pull-handle, for glue fixing, 30 mm (1 3/16"), aluminum, anodized, 50-piece set	053.3091.983
	Finger-pull-handle, for glue fixing, 40 mm (1 9/16"), aluminum, anodized	053.3158.901

Accessories

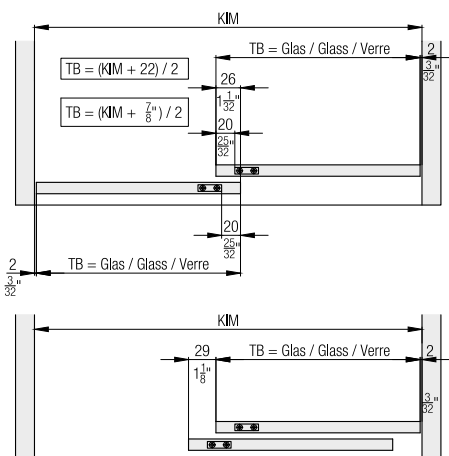
	No.
 Track cleaner, plastic, red	040.3142.071

Further installation examples



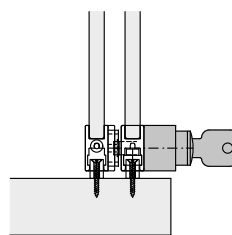
* Zentrierhilfe für 6mm Glas
 Centering help for 6mm glass
 Aide de centrage pour verre 6mm

Calculations

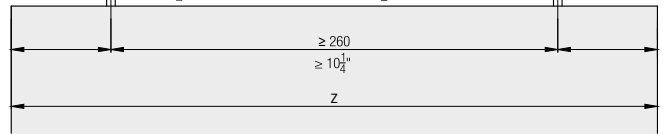


Locking systems

Details from page 242 onwards

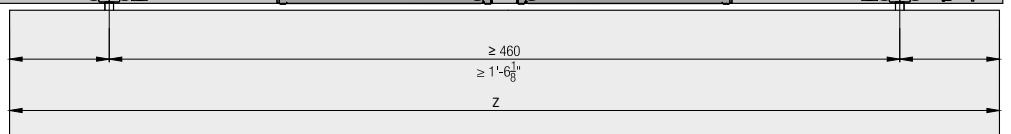


Soft close



	Z ≥	
	1	2
Hawa Porta 40 H	1' 4 ¹⁷ / ₃₂ "	2' 0 ¹³ / ₃₂ "
Hawa Porta 40 GE	1' 2 ¹³ / ₁₆ "	1' 10 ¹¹ / ₁₆ "
Hawa Clipo 26 H IS	1' 4 ¹⁷ / ₃₂ "	2' 0 ¹³ / ₃₂ "
Hawa Clipo 26 H MS	1' 6 ¹ / ₃₂ "	2' 1 ²⁹ / ₃₂ "
Hawa Clipo 36 H IS	1' 4 ¹⁷ / ₃₂ "	2' 0 ¹³ / ₃₂ "
Hawa Clipo 36 H MS	1' 6 ¹ / ₃₂ "	2' 1 ²⁹ / ₃₂ "
Hawa Clipo 36 HM IS	1' 4 ¹⁷ / ₃₂ "	2' 0 ¹³ / ₃₂ "
Hawa Clipo 26 GR IS	1' 4 ¹⁷ / ₃₂ "	2' 0 ¹³ / ₃₂ "
Hawa Clipo 36 G IS	1' 4 ¹⁷ / ₃₂ "	2' 0 ¹³ / ₃₂ "
Hawa Clipo 36 GPK IS	1' 4 ¹⁷ / ₃₂ "	2' 0 ¹³ / ₃₂ "
Hawa Clipo 36 GPPK IS	1' 4 ¹⁷ / ₃₂ "	2' 0 ¹³ / ₃₂ "
Hawa Regal C 26 HM IS	1' 4 ¹⁷ / ₃₂ "	2' 0 ¹³ / ₃₂ "
Hawa Regal C 26 GR IS	1' 3 ³ / ₄ "	1' 11 ⁵ / ₈ "

	Z ≥	
	1	2
Hawa Porta 40 H	420	620
Hawa Porta 40 GE	376	576
Hawa Clipo 26 H IS	420	620
Hawa Clipo 26 H MS	458	658
Hawa Clipo 36 H IS	420	620
Hawa Clipo 36 H MS	458	658
Hawa Clipo 36 HM IS	420	620
Hawa Clipo 26 GR IS	420	620
Hawa Clipo 36 G IS	420	620
Hawa Clipo 36 GPK IS	420	620
Hawa Clipo 36 GPPK IS	420	620
Hawa Regal C 26 HM IS	420	620
Hawa Regal C 26 GR IS	400	600



Accessories

- Locking systems from page 242
- Glass recommendations from page 249

Planning/execution

Further information about the product can be found on www.hawa.com.

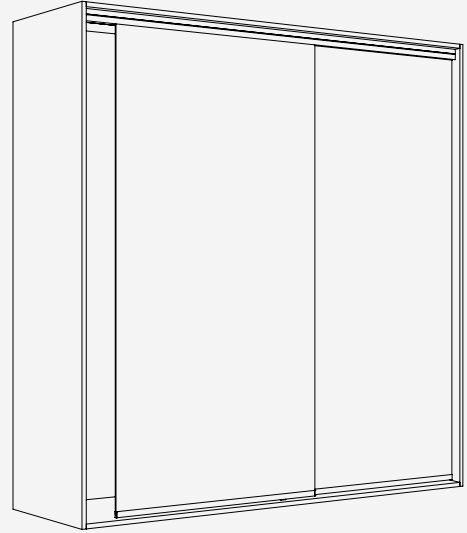
Fitting for 1 top-running glass door up to 36 kg (79 lbs.), with screwed on running track. With fixed glass support profile. With soft and self closing mechanism. Design Inside.

Product highlights

- Comfort** Quiet, smooth running and soft and self closing system for different door weights
- Productivity** No groove in the base and invisible technology

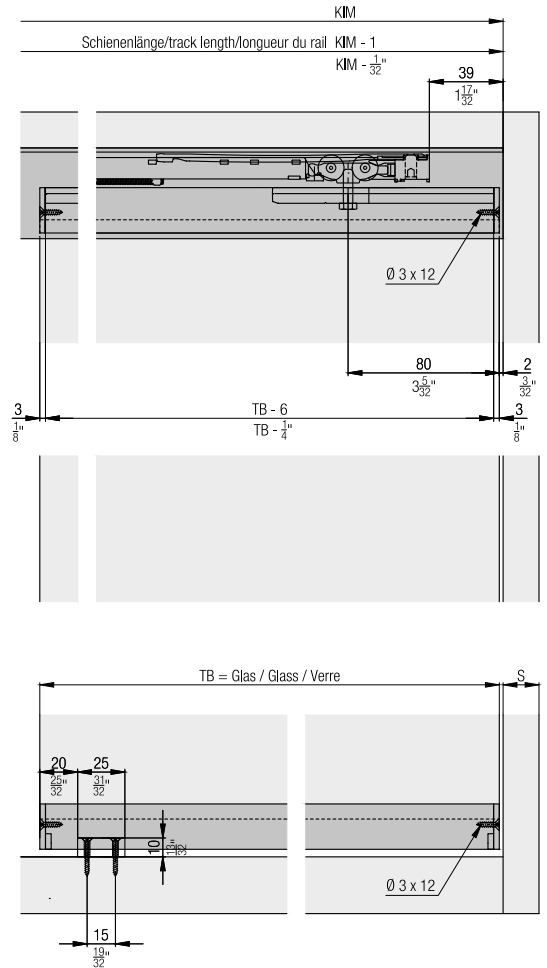
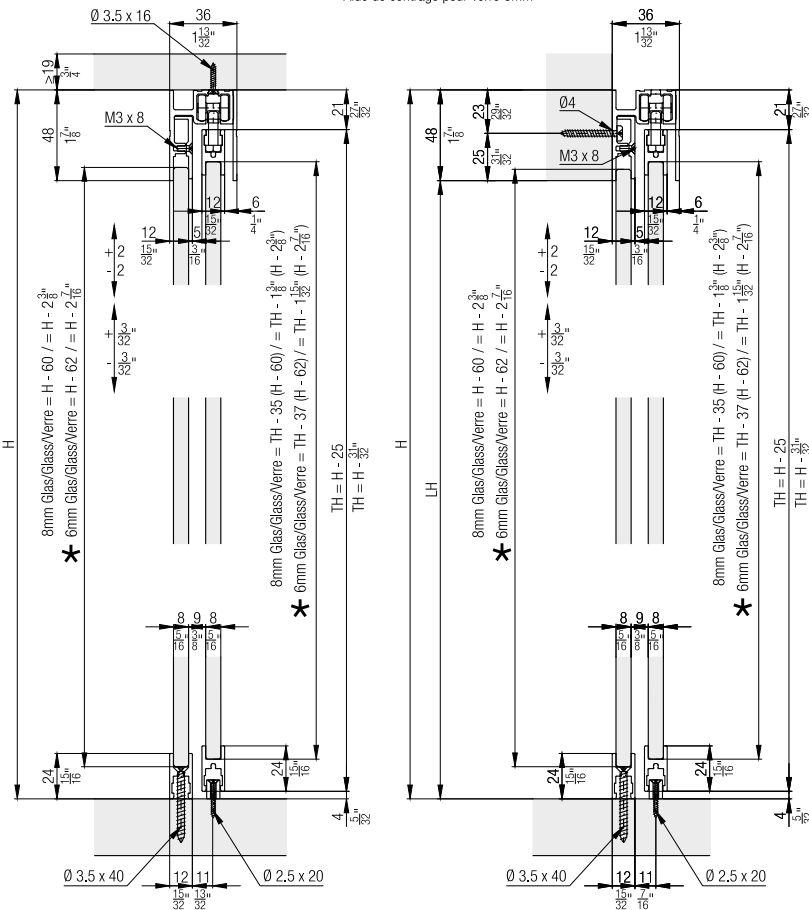
Technical specifications

- Max. 36 kg (79 lbs.)
- Max. 2000 mm (6'6 3/4")
- Max. 1000 mm (3'3 3/8")
- 6-8 mm (1/4" to 5/16")



Installation examples

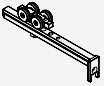






★ Zentrierhilfe für 6mm Glas
Centering help for 6mm glass
Aide de centrage pour verre 6mm



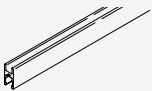
Set for 1 glass door up to 36 kg (79 lbs.), with height adjustment

	No.
Hawa Clipo 36 GPPK, for 1 door	053.3361.072

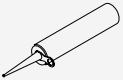
Set consisting of:

		053.3361.072	No.
	Running gear	2	053.3344.071
	Flat countersunk head chipboard screw, 3x12 mm (1/8" x 15/32"), steel, zinc-plated, black	5	600.0000.703
	Stopper, plastic, gray	2	057.3148.071
	Centring help, for 6 mm (1/4") glass	8	053.3139.001
	End cover	3	053.0329.001
	Bottom guide	1	053.0333.001
	Flat countersunk head chipboard screw 2.5x20 mm (1/8" x 25/32"), steel, zinc-plated	2	600.0000.705

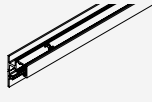
Suspension and glass retaining profiles

		mm (inch)	No.
	Glass fixing profile, aluminum, anodized	2,500 (8' 2 7/16")	053.3072.250
		3,500 (11' 5 25/32")	053.3072.350
		6,000 (19' 8 7/32")	053.3072.600

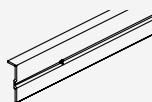
Adhesive

		No.
	Glue Ceresit 3B Silicone, 310 ml	098.0027.000


Running tracks

		mm (inch)	No.
	Single running track, with panel, for screw fixing, aluminum, anodized	2,500 (8' 2 7/16")	053.3338.250

Fixed glass support profiles

		mm (inch)	No.
	Fixed glass support profile, aluminum, anodized, pre-drilled	2,500 (8' 2 7/16")	053.3071.250

Panels

		mm (inch)	No.
	Panel, aluminum, anodized (use double-sided adhesive tape)	2,500 (8' 2 7/16")	053.3075.250

Soft close up to 15/26/36 kg (33/57/79 lbs.)




		No.
Soft close, up to 15 kg (33 lbs.)		057.3159.071
Soft close, up to 26 kg (57 lbs.)		057.3159.072
Soft close, up to 40 kg (88 lbs.)		057.3159.073

		057.3159.071	057.3159.072	057.3159.073	No.

Set consisting of:


	Soft close, up to 15 kg (33 lbs.)	2			057.3156.071
	Release piece soft close	2	2	2	057.0182.101
	Thread rolling rounded head screw, M2.5x5 mm (3/32" x 3/16"), steel, zinc-plated	2	2	2	600.0000.764
	Soft close, up to 26 kg (57 lbs.)		2		057.3156.072
	Soft close, up to 40 kg (88 lbs.)			2	057.3156.073

Handles


		No.
	Handle, for glue fixing, 64 mm (2 17/32"), plastic, chrome-plated, matt, 2-piece set	053.3323.971
	Finger-pull-handle, for glue fixing, 30 mm (1 3/16"), aluminum, anodized, 2-piece set	053.3091.982
	Finger-pull-handle, for glue fixing, 30 mm (1 3/16"), aluminum, anodized, 50-piece set	053.3091.983
	Finger-pull-handle, for glue fixing, 40 mm (1 9/16"), aluminum, anodized	053.3158.901

Screw set

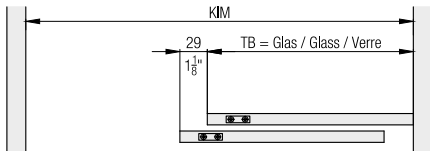
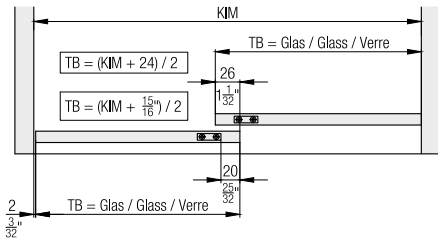
		No.
Fixing screws to fix glass profile Hawa Clipo 36, 50-piece set		098.0007.101

		098.0007.101	No.
Set consisting of:			
	Thread rolling rounded head screw, M3x8 mm (1/8"x5/16"), steel, zinc-plated	50	762.7007.100

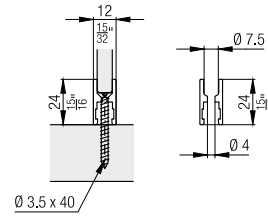
Accessories

		No.
	Track cleaner, plastic, red	040.3142.071

Calculations

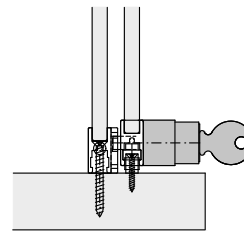


Support and glass retaining profile attached to base



Locking systems

Details from page 242 onwards

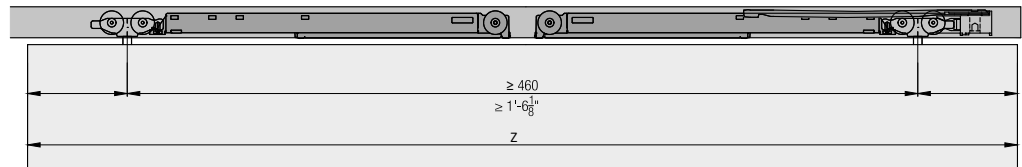
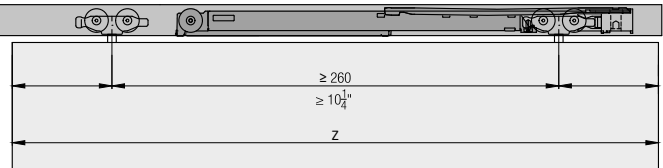


Soft close



	Z ≥	
	1	2
Hawa Porta 40 H	1' 4 17/32"	2' 0 13/32"
Hawa Porta 40 GE	1' 2 13/16"	1' 10 11/16"
Hawa Clipo 26 H IS	1' 4 17/32"	2' 0 13/32"
Hawa Clipo 26 H MS	1' 6 3/32"	2' 1 29/32"
Hawa Clipo 36 H IS	1' 4 17/32"	2' 0 13/32"
Hawa Clipo 36 H MS	1' 6 1/32"	2' 1 29/32"
Hawa Clipo 36 HM IS	1' 4 17/32"	2' 0 13/32"
Hawa Clipo 26 GR IS	1' 4 17/32"	2' 0 13/32"
Hawa Clipo 36 G IS	1' 4 17/32"	2' 0 13/32"
Hawa Clipo 36 GPK IS	1' 4 17/32"	2' 0 13/32"
Hawa Clipo 36 GPPK IS	1' 4 17/32"	2' 0 13/32"
Hawa Regal C 26 HM IS	1' 4 17/32"	2' 0 13/32"
Hawa Regal C 26 GR IS	1' 3 3/4"	1' 11 5/8"

	Z ≥	
	1	2
Hawa Porta 40 H	420	620
Hawa Porta 40 GE	376	576
Hawa Clipo 26 H IS	420	620
Hawa Clipo 26 H MS	458	658
Hawa Clipo 36 H IS	420	620
Hawa Clipo 36 H MS	458	658
Hawa Clipo 36 HM IS	420	620
Hawa Clipo 26 GR IS	420	620
Hawa Clipo 36 G IS	420	620
Hawa Clipo 36 GPK IS	420	620
Hawa Clipo 36 GPPK IS	420	620
Hawa Regal C 26 HM IS	420	620
Hawa Regal C 26 GR IS	400	600



Accessories

- Locking systems from page 242
- Glass recommendations from page 249


Planning/execution

Further information about the product can be found on www.hawa.com.

Set for 1 glass door up to 36 kg (79 lbs.), with height adjustment

	No.
Hawa Clipo 36 G IS, for 1 door	053.3363.071

Set consisting of:




	053.3363.071	No.
 Running gear, plain bearings, rollers, plastic, white	2	057.3149.071
 Stopper, plastic, gray	2	057.3148.071
 Hexagon screw, M5x18 mm (3/16"x23/32"), steel, zinc-plated	2	600.0000.646
 Prevailing torque, M5, steel, zinc-plated	2	600.0000.459
 Clamping shoe, zinc diecast, aluminum, glass thickness 6–8 mm (1/4"-5/16")	2	053.3161.071
 Bottom guide glass, playfree, chrome-plated, matt	1	053.3097.901
 Slider bottom guide, plastic, grey, 4-piece set	1	053.0146.001
 Flat countersunk head chipboard screw, 3x12 mm (1/8"x15/32"), steel, zinc-plated	2	766.5030.112

Running tracks

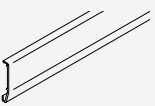
		mm (inch)	No.
	A: Single running track, for glue fixing, aluminum, anodized	2,500 (8' 2 7/16")	053.3324.250
		3,500 (11' 5 25/32")	053.3324.350
		6,000 (19' 8 7/32")	053.3324.600
	B: Single running track, swivel lug, aluminum, anodized (not for hard wood/ MDF)	2,500 (8' 2 7/16")	053.3327.250
		3,500 (11' 5 25/32")	053.3327.350
		6,000 (19' 8 7/32")	053.3327.600
	C: Single running track, for screw fixing, aluminum, anodized	2,500 (8' 2 7/16")	053.3325.250
		3,500 (11' 5 25/32")	053.3325.350
		6,000 (19' 8 7/32")	053.3325.600
	H: Single running track, for screw fixing, aluminum, anodized	2,500 (8' 2 7/16")	053.3326.250
		3,500 (11' 5 25/32")	053.3326.350
		6,000 (19' 8 7/32")	053.3326.600

Track end piece set for single running tracks

	No.
Track-end section, for screw fixing, plastic, gray, 2-piece set	053.3354.071
Track-end section, swivel lug, plastic, gray, 2-piece set	053.3355.051

	053.3354.071	053.3355.051	No.
Set consisting of:			
 Track-end piece, for screw fixing, plastic	2		053.0334.001
 Chipboard screw, 4x12 mm (5/32"x15/32"), steel, zinc-plated	2		600.0000.704
 Track-end piece, with swivel lug, plastic		2	053.3351.071




Panels

		mm (inch)	No.
	Clip-on panel for clamping shoe, aluminum, anodized	2,500 (8' 2 7/16")	053.3168.250
		3,500 (11' 5 25/32")	053.3168.350
		6,000 (19' 8 7/32")	053.3168.600

End cap set

	No.
End cap for clip	053.3163.072

Set consisting of:

		053.3163.072	No.
	Cover cap, plastic, anthracite	2	053.3169.001
	Clip to panel, plastic, gray	4	057.3060.001
	Sealing profile, 60 mm (2 3/8"), plastic, black	2	057.3072.002




Soft close up to 15/26/36 kg (33/57/79 lbs.)

	No.
Soft close, up to 15 kg (33 lbs.)	057.3159.071
Soft close, up to 26 kg (57 lbs.)	057.3159.072
Soft close, up to 40 kg (88 lbs.)	057.3159.073


Set consisting of:

		057.3159.071	057.3159.072	057.3159.073	No.
	Soft close, up to 15 kg (33 lbs.)	2			057.3156.071
	Release piece soft close	2	2	2	057.0182.101
	Thread rolling rounded head screw, M2.5x5 mm (3/32"x3/16"), steel, zinc-plated	2	2	2	600.0000.764
	Soft close, up to 26 kg (57 lbs.)		2		057.3156.072
	Soft close, up to 40 kg (88 lbs.)			2	057.3156.073

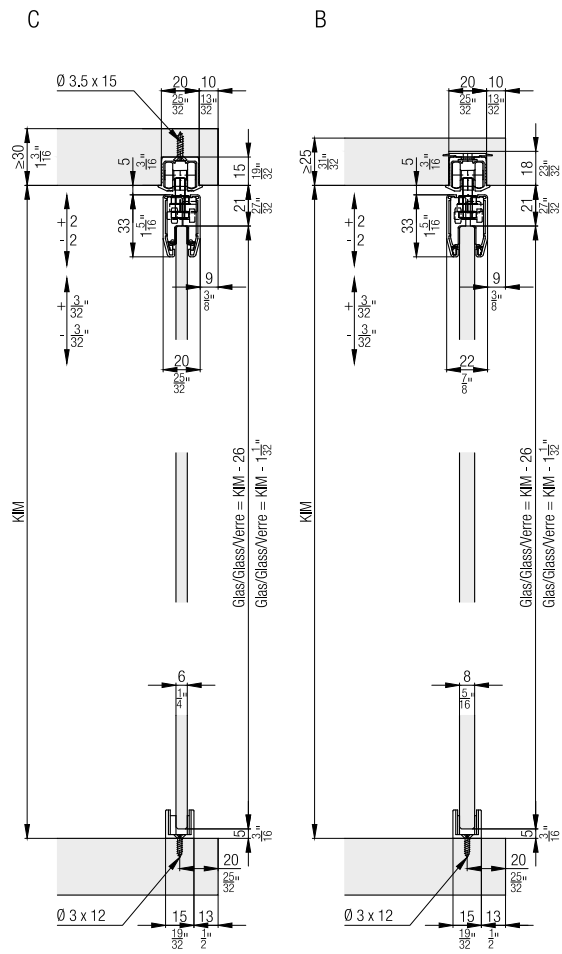
Handles

		No.
	Handle, for glue fixing, 64 mm (2 17/32"), plastic, chrome-plated, matt, 2-piece set	053.3323.971
	Finger-pull-handle, for glue fixing, 30 mm (1 3/16"), aluminum, anodized, 2-piece set	053.3091.982
	Finger-pull-handle, for glue fixing, 30 mm (1 3/16"), aluminum, anodized, 50-piece set	053.3091.983
	Finger-pull-handle, for glue fixing, 40 mm (1 9/16"), aluminum, anodized	053.3158.901

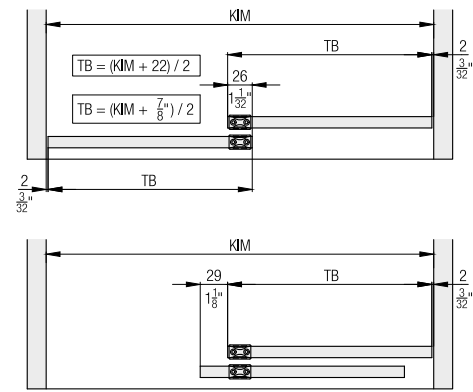
Accessories

		No.
	Track cleaner, plastic, red	040.3142.071

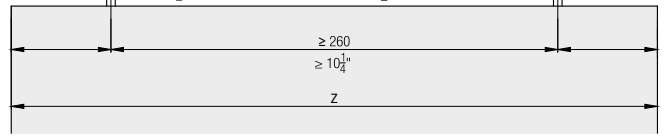
Further installation examples



Calculations

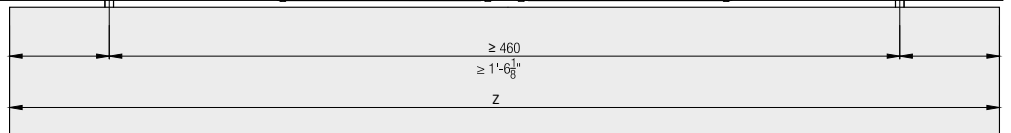


Soft close



	Z ≥	
	1	2
Hawa Porta 40 H	1' 4 ¹⁷ / ₃₂ "	2' 0 ¹³ / ₃₂ "
Hawa Porta 40 GE	1' 2 ¹³ / ₁₆ "	1' 10 ¹¹ / ₁₆ "
Hawa Clipo 26 H IS	1' 4 ¹⁷ / ₃₂ "	2' 0 ¹³ / ₃₂ "
Hawa Clipo 26 H MS	1' 6 ¹ / ₃₂ "	2' 1 ²⁹ / ₃₂ "
Hawa Clipo 36 H IS	1' 4 ¹⁷ / ₃₂ "	2' 0 ¹³ / ₃₂ "
Hawa Clipo 36 H MS	1' 6 ¹ / ₃₂ "	2' 1 ²⁹ / ₃₂ "
Hawa Clipo 36 HM IS	1' 4 ¹⁷ / ₃₂ "	2' 0 ¹³ / ₃₂ "
Hawa Clipo 26 GR IS	1' 4 ¹⁷ / ₃₂ "	2' 0 ¹³ / ₃₂ "
Hawa Clipo 36 G IS	1' 4 ¹⁷ / ₃₂ "	2' 0 ¹³ / ₃₂ "
Hawa Clipo 36 GPK IS	1' 4 ¹⁷ / ₃₂ "	2' 0 ¹³ / ₃₂ "
Hawa Clipo 36 GPPK IS	1' 4 ¹⁷ / ₃₂ "	2' 0 ¹³ / ₃₂ "
Hawa Regal C 26 HM IS	1' 4 ¹⁷ / ₃₂ "	2' 0 ¹³ / ₃₂ "
Hawa Regal C 26 GR IS	1' 3 ³ / ₄ "	1' 11 ⁵ / ₈ "

	Z ≥	
	1	2
Hawa Porta 40 H	420	620
Hawa Porta 40 GE	376	576
Hawa Clipo 26 H IS	420	620
Hawa Clipo 26 H MS	458	658
Hawa Clipo 36 H IS	420	620
Hawa Clipo 36 H MS	458	658
Hawa Clipo 36 HM IS	420	620
Hawa Clipo 26 GR IS	420	620
Hawa Clipo 36 G IS	420	620
Hawa Clipo 36 GPK IS	420	620
Hawa Clipo 36 GPPK IS	420	620
Hawa Regal C 26 HM IS	420	620
Hawa Regal C 26 GR IS	400	600



Accessories

– Glass recommendations from page 249



Planning/execution

Further information about the product can be found on www.hawa.com.




Accessories

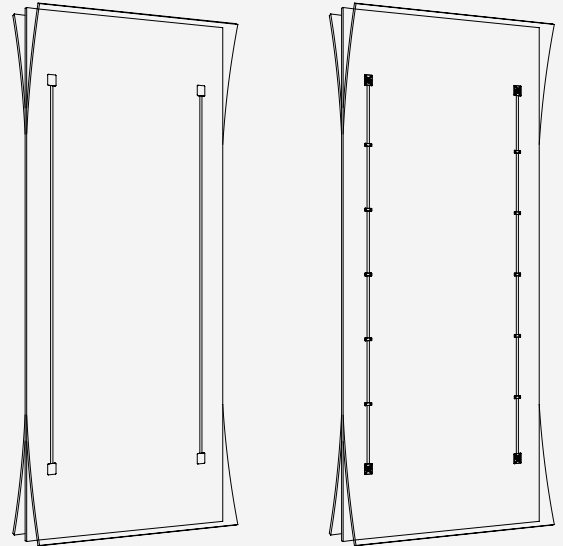
Straightening fitting for stabilizing 1215 to 2850 mm (3'11 27/32" to 9'4 7/32") high wooden doors (not suitable for hardwood)

Product highlights

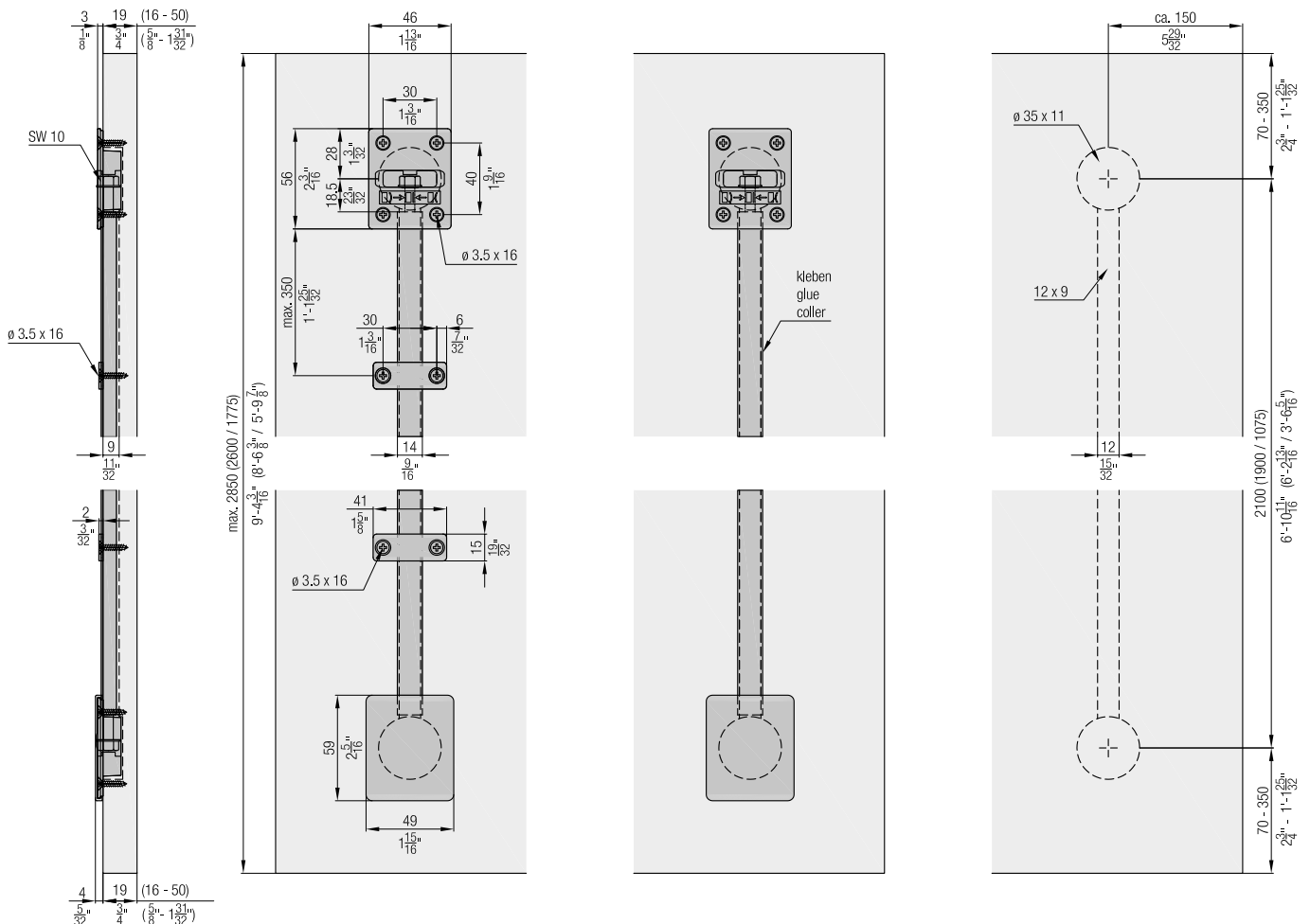
- 
Flexibility The right solution for every application thanks to selectable heights and three different finish colors
The tightening profile can be glued on or screwed on as required
- 
Comfort The stable structure holds the doors in position and remains silent during operation

Technical specifications

-  1215–2850 mm (3'11 27/32" to 9'4 7/32")
-  300–1600 mm (11 13/16" to 5'3")
-  16–50 mm (5/8" to 1 31/32")






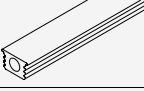



Installation examples





Aluminum

	No.
Straightening fitting for doors up to 2240–2850 mm (7'4 3/16"–9'4 7/32"), aluminum, anodized, can be shortened for doors 1215–2240 mm (3'11 27/32"–7'4 3/16")	056.3192.071
Straightening fitting for doors up to 2040–2600 mm (6'8 5/16"–8'6 3/8"), aluminum, can be shortened for doors 1775–2040 mm (5'9 7/8"–6'8 5/16")	056.3192.072
Straightening fitting for doors up to 1215–1775 mm (3'11 27/32"–5'9 7/8"), aluminum	056.3192.073

Set consisting of:		mm (inch)	056.3192.071	056.3192.072	056.3192.073	No.
	Armature element, zinc alloy		4			056.0199.001
	Bracket, plastic, black		10	10	10	056.2023.001
	Thread-cutting hexagon screw, M6x40 mm, steel, zinc-plated		4	4	4	056.0130.101
	Tightening profile, aluminum, anodized	2063 6'9 7/32"	2			056.0200.226
	Armature element, plastic, black			4	4	056.2024.001
	Tightening profile, aluminum	1863 6'1 11/32"		2		056.0200.186
	Tightening profile, aluminum	1038 3'4 7/8"			2	056.0200.103

Accessories

	No.
	056.0201.071
	056.0118.004

Ordering information




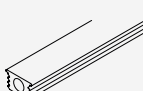

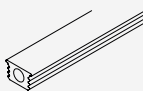
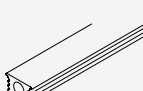
– Type and number of sets

Optional ordering information

– Number of cover caps
– Number of brackets

Aluminum, black anodized

	No.
Straightening fitting for doors up to 2240–2850 mm (7'4 3/16"–9'4 7/32"), aluminum, anodized, black	056.3192.074
Straightening fitting for doors up to 2040–2600 mm (6'8 5/16"–8'6 3/8"), aluminum, anodized, black, can be shortened for doors 1775–2040 mm (5'9 7/8"–6'8 5/16")	056.3192.075
Straightening fitting for doors up to 1215–1775 mm (3'11 27/32"–5'9 7/8"), aluminum, anodized, black	056.3192.076

Set consisting of:		mm (inch)	056.3192.074	056.3192.075	056.3192.076	No.
	Armature element, zinc alloy		4			056.0199.001
	Cover cap, plastic, black		4			056.0201.001
	Thread-cutting hexagon screw, M6x40 mm, steel, zinc-plated		4	4	4	056.0130.101
	Tightening profile, aluminum, anodized, black	2063 6'9 7/32"	2			056.0200.207
	Armature element, plastic, black			4	4	056.2024.001
	Tightening profile, aluminum, anodized, black	1863 6'1 11/32"		2		056.0200.187
	Tightening profile, aluminum, anodized, black	1038 3'4 7/8"			2	056.0200.104

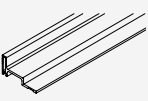
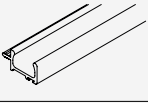


Planning/execution

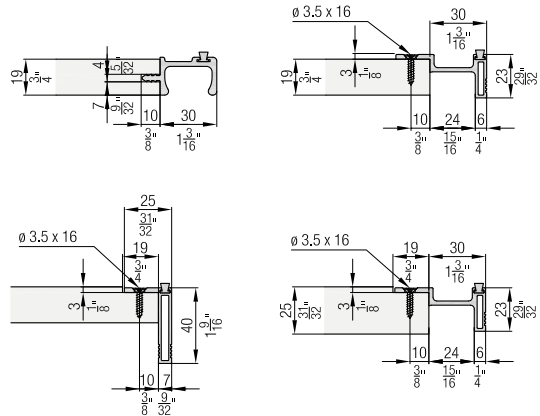
All straightening fittings can be shortened to the required dimension.

Installation instructions No. 788.2000.314 have to be used for planning and execution. Further information about the product can be found on www.hawa.com.




Accessories

Handle profiles


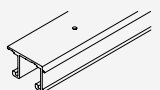
		mm (inch)	No.
	Handle profile, groove for brush seal, aluminum, anodized, for screw fixing	2500 (8'2 7/16")	055.3141.250
		6000 (19'8 7/32")	055.3141.600
	Handle profile, groove for brush seal, aluminum, anodized, for groove mounting	2500 (8'2 7/16")	056.3028.250
		6000 (19'8 7/32")	056.3028.600
	Handle profile, groove for brush seal, aluminum, anodized, for screw fixing	2500 (8'2 7/16")	055.3140.250
		6000 (19'8 7/32")	055.3140.600
	Brush seal, in rolls, gray	10000 (32'9 11/16")	053.3040.100




Individual components Hawa Combino 20

		No.
	Angled running gear, Hawa Combino 20, with friction bearing	056.3007.172
	Angled running gear, Hawa Combino 20, with ball bearing	056.3007.171
	Clip-on component, for wooden panel, every 500 mm (1'7 11/16"), aluminum, pre-drilled	056.3039.001

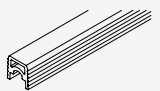
Running tracks

		mm (inch)	No.
	Single running track, aluminum, pre-drilled	2500 (8'2 7/16")	056.3011.250
		3500 (11'5 25/32")	056.3011.350
		6000 (19'8 7/32")	056.3011.600
	Double running track, aluminum, pre-drilled	2500 (8'2 7/16")	056.3010.250
		3500 (11'5 25/32")	056.3010.350
		6000 (19'8 7/32")	056.3010.600


Panels

		mm (inch)	No.
	Clip-on panel, aluminum, anodized	2500 (8'2 7/16")	056.3174.250
		3500 (11'5 25/32")	056.3174.350
		6000 (19'8 7/32")	056.3174.600



Guide tracks

		mm (inch)	No.
	Guide track, plastic, gray, for glue fixing	2500 (8'2 7/16")	055.3171.250
		3500 (11'5 25/32")	055.3171.350
		6000 (19'8 7/32")	055.3171.600

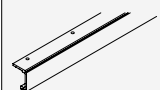
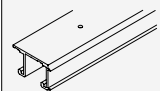
Bottom guide

		No.
	Bottom guide, plastic, gray	055.3081.071

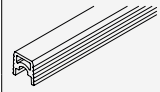
Individual components Hawa Combino 60

		No.
	Angled running gear, Hawa Combino 60, with ball bearing	055.3004.171
	Clip-on component, for wooden panel, every 700–800 mm (2'3 9/16"–2'7 1/2"), aluminum, pre-drilled	055.3084.001


Running tracks

		mm (inch)	No.
	Single running track, aluminum, pre-drilled	6000 (19'8 7/32")	055.3001.600
	Double running track, aluminum, pre-drilled	6000 (19'8 7/32")	055.3000.600

Guide tracks

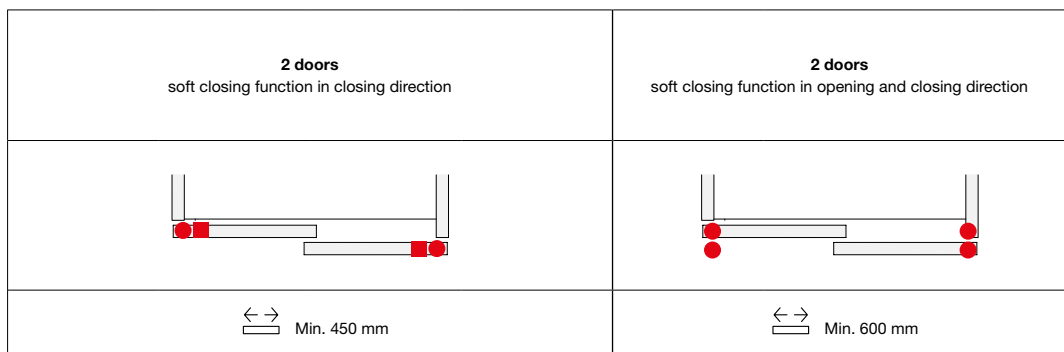
		mm (inch)	No.
	Guide track, plastic, gray, for glue fixing	2500 (8'2 7/16")	055.3171.250
		3500 (11'5 25/32")	055.3171.350
		6000 (19'8 7/32")	055.3171.600

Bottom guide

		No.
	Bottom guide, plastic, gray	055.3081.071

Hawa Combino Soft close

Order overview




Designation	Up to 18 kg	18 to 40 kg	Up to 50 kg	Up to 65 kg	Up to 50 kg	Up to 65 kg	Up to 80 kg
Hawa Combino 20/35 H IS/MS	● 1x 055.3091.071 ■ 1x 055.3043.073	● 1x 055.3091.073 ■ 1x 055.3043.073					
Hawa Combino 20/35 H FS (installation outside)	● 1x 055.3091.072 ■ 1x 055.3129.071	● 1x 055.3091.074 ■ 1x 055.3129.071					
Hawa Combino 20/35 H FS (installation inside)	● 1x 055.3091.071	● 1x 055.3091.073					
Hawa Combino L 40 H FS	● 1x 055.3091.072 ■ 1x 056.3164.071	● 1x 055.3091.074 ■ 1x 056.3164.071					
Hawa Combino 50 H MS with soft close			● 1x 055.3215.071		● 1x 055.3215.072		
Hawa Combino 50 H FS with soft close			● 1x 055.3215.071		● 1x 055.3215.072		
Hawa Combino 65 H IS/MS				● 1x 055.3214.071		● 2x 055.3214.071	
Hawa Combino 65 H FS br				● 1x 055.3212.071		● 2x 055.3212.071	
Hawa Combino 65 H FS tr				● 1x 055.3206.071		● 2x 055.3206.071	
Hawa Combino 80 FS br							● 1x 055.3213.071
Hawa Combino 80 H FS tr							● 1x 055.3206.072

- Soft close
- ▲ Soft close center door
- Adapter

3 doors Exterior door with soft closing function in opening and closing direction Interior doors with soft closing function in closing direction			3 doors Exterior door with soft closing function in opening and closing direction Interior doors with soft closing function in closing direction and soft close center door			3 doors soft closing function in opening and closing direction and soft close center door
Up to 50 kg	Up to 65 kg	Up to 80 kg	Up to 50 kg	Up to 65 kg	Up to 80 kg	Up to 80 kg
●1x 055.3215.072						
●1x 055.3215.072			●1x 055.3215.072 ▲1x 055.3216.071			
	●2x 055.3214.071					
	●2x 055.3212.071			●2x 055.3212.071 ▲1x 055.3217.071		
	●2x 055.3206.071			●2x 055.3206.071 ▲1x 055.3207.071		
		●1x 055.3213.071			●1x 055.3213.071 ▲1x 055.3217.071	
		●1x 055.3206.072			●1x 055.3206.072 ▲1x 055.3207.071	●1x 055.3206.073 ▲1x 055.3207.071

Accessories











Locking systems Hawa Clipo 36 GPK

		No.
	Locking system, with thrust bolt, GPK	053.3147.071

Locking systems Hawa Clipo 36 GPPK, Lehmann

		No.
Locking system "Lehmann", with cylinder, GPPK (L-MZ), left closing lock		053.3141.071
Locking system "Lehmann", with cylinder, GPPK (L-MZ), right closing lock		053.3142.071
Locking system "Lehmann", without cylinder, GPPK (L-OZ), left closing lock, for Lehmann cylinder type no. Z17/Z23 prestige		053.3143.071
Locking system "Lehmann", without cylinder, GPPK (L-OZ), right closing lock, for Lehmann cylinder type no. Z17/Z23 prestige		053.3143.072









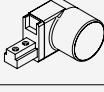
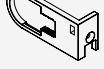
Set consisting of:

		053.3141.071	053.3142.071	053.3143.071	053.3143.072	No.
	Locking System Lehmann, without cylinder, left	1		1		053.3140.071
	Lock cylinder, locking 7301	1	1			752.4030.001
	Locking adapter right	1		1		053.3125.102
	Locking plate 3.5 mm (5/32")	1	1	1	1	053.3126.101
	Locking plate 5.5 mm (1/4")	1	1	1	1	053.3126.102
	Locking pin, locking system Lehmann	1	1	1	1	053.3196.001
	Glide pin	1	1	1	1	025.0119.001
	Flat countersunk head chipboard screw, 3x12 mm (1/8"x15/32"), steel, zinc-plated	1	1	1	1	766.5030.112
	Locking System Lehmann, without cylinder, right			1	1	053.3140.072
	Locking adapter left		1		1	053.3125.101

Locking systems Hawa Clipo 36 GPPK, Kaba



		No.
Locking system "Kaba", without cylinder, GKK (K-OZ), left closing lock, for Kaba push-button cylinder type no. 1064		053.3145.071
Locking system "Kaba", without cylinder, GPPK (K-OZ), right closing lock, for Kaba push-button cylinder type no. 1064		053.3145.072

Set consisting of:

		053.3145.071	053.3145.072	No.
	Housing Kaba, without cylinder, left hand lock	1		053.3144.071
	Slotted cheese head screw M3x5 mm (1/8"x3/16")	2	2	759.0305.105
	Locking adapter right	1		053.3125.102
	Flat countersunk head chipboard screw, 3x12 mm (1/8"x15/32"), steel, zinc-plated	1	1	766.5030.112
	Locking plate 3.5 mm (5/32")	1	1	053.3126.101
	Locking plate 5.5 mm (1/4")	1	1	053.3126.102
	Locking pin 7x11.5 mm (9/32"x15/32")	1	1	053.0160.901
	Glide pin	1	1	025.0119.001
	Housing Kaba, without cylinder, right hand lock		1	053.3144.072
	Locking adapter left		1	053.3125.101

Different keyed cylinders available on request!

Guide to determine right hand or left hand lock

L	R
links schliessendes Schloss left closing lock fermeture à gauche	rechts schliessendes Schloss right closing lock fermeture à droite
	
Front door right = left hand lock type	Front door left = right hand lock type

Accessories

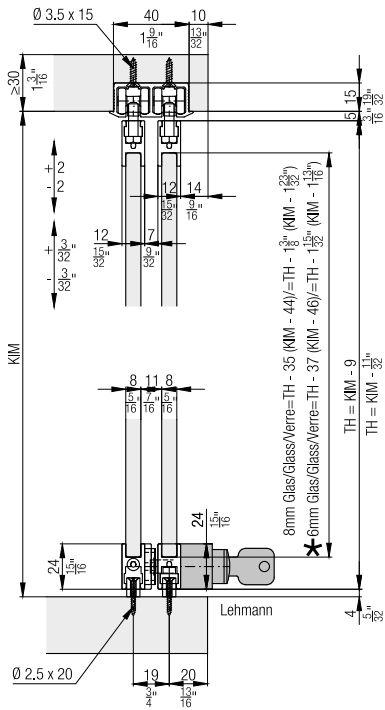
Installation examples

Hawa Clipo 36 GPPK IS (L-MZ/L-OZ)

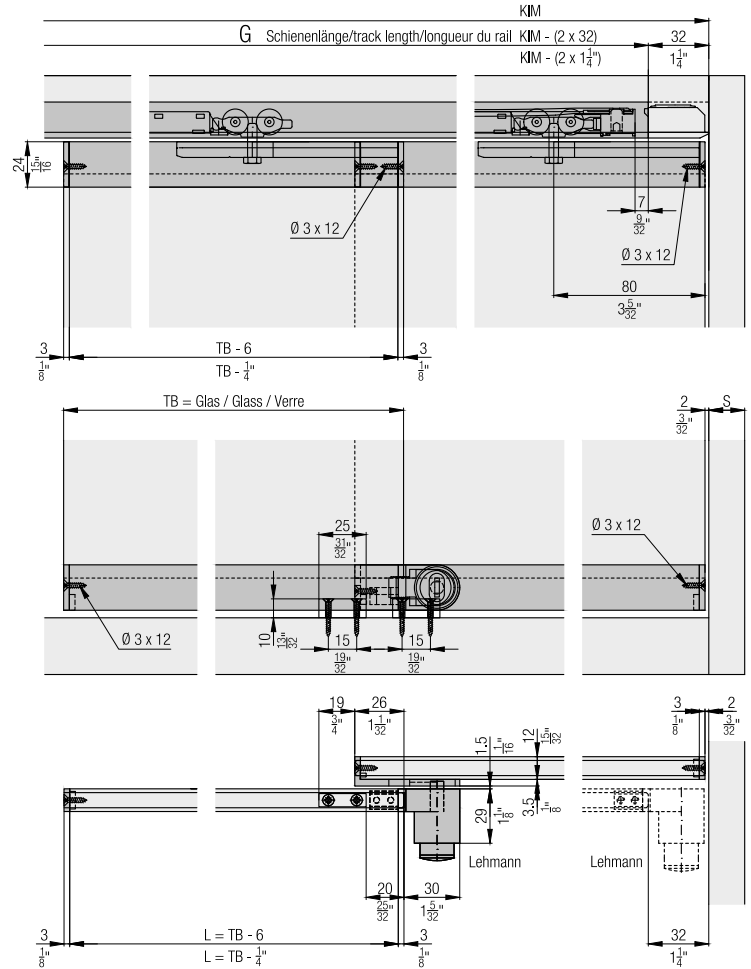
L-MZ: 053.3141.071, 053.3142.071

L-OZ: 053.3143.071, 053.3143.072

G



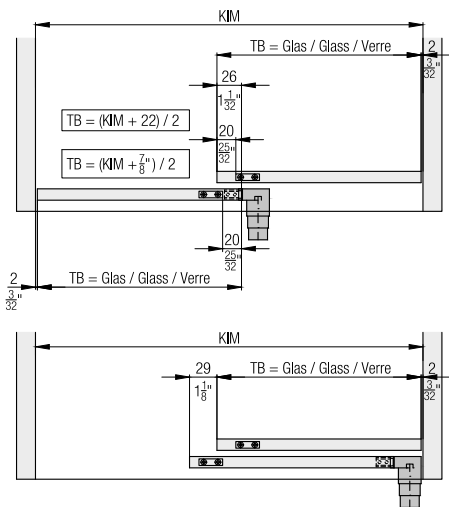
★ Zentrierhilfe für 6mm Glas
Centering help for 6mm glass
Aide de centrage pour verre 6mm



Hawa Clipo 36 GPPK IS (L-MZ/L-OZ)

L-MZ: 053.3141.071, 053.3142.071

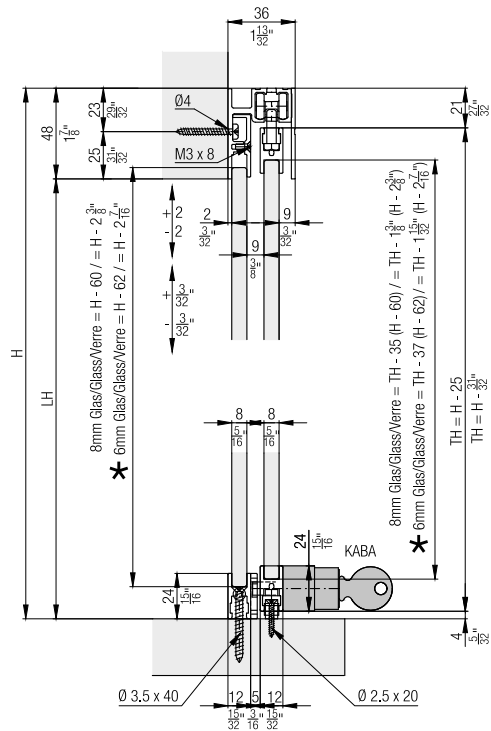
L-OZ: 053.3143.071, 053.3143.072



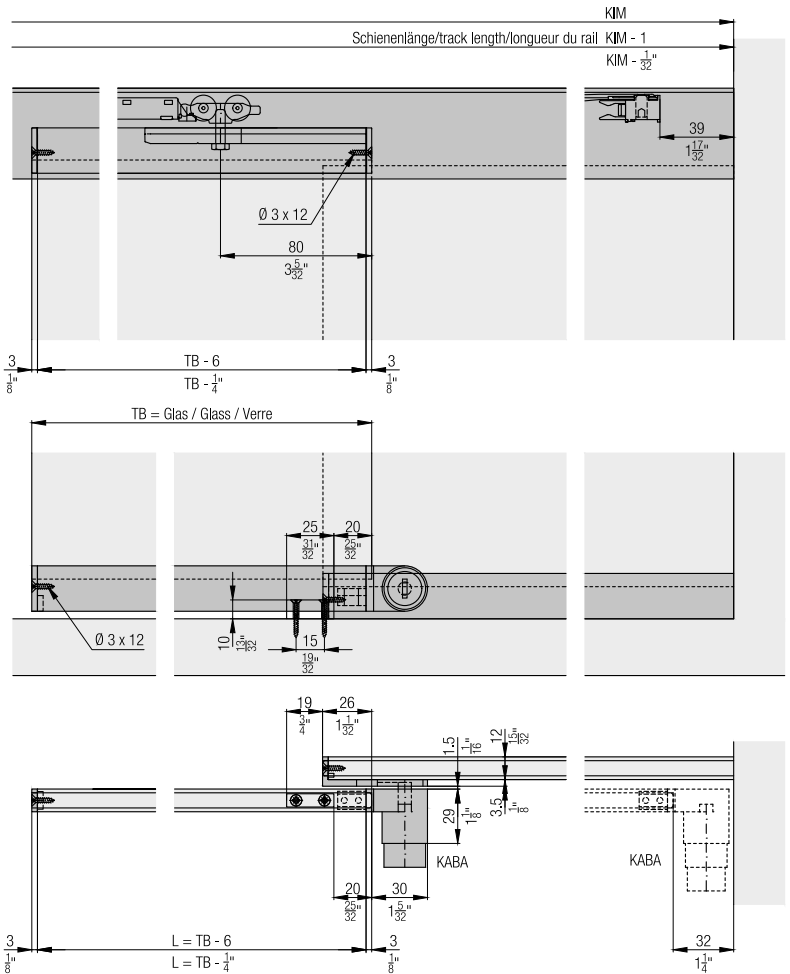
Installation examples

Hawa Clipo 36 GPPK IS Fixed glass (K-OZ)

K-OZ: 053.3145.071, 053.3145.072



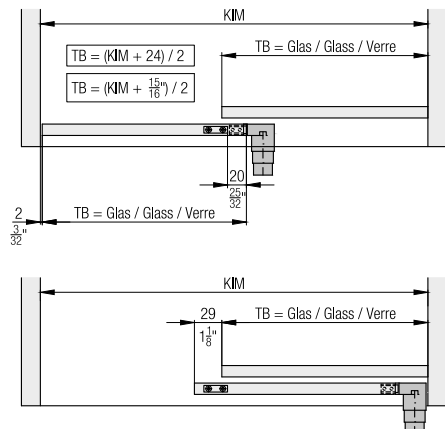
★ Zentrierhilfe für 6mm Glas
Centering help for 6mm glass
Aide de centrage pour verre 6mm



Calculation

Hawa Clipo 36 GPPK IS Fixed glass (K-OZ)

K-OZ: 053.3145.071, 053.3145.072



Accessories

– Glass recommendations from page 249

Planning/execution

Further information about the product can be found on www.hawa.com.

The right sliding solution on furniture for every need and every idea



On furniture

	Technical specifications					Design/installation							Recommended application		
Wood															
Sliding doors															
Hawa 220 Planfront	70	19-45	2600	400-1500					X		X		X	X	X
Hawa 220 Planfront 70	70	19-45	2600	400-1500					X		X		X	X	X
Hawa Clipo	15/16/26/36	10-25	2400	1200	X	X	X	X	X		X		X	X	X
Hawa Clipo 15 H IS	15	16-19	1400	1000		X			X				X	X	
Hawa Clipo 15 H MS	15	16-19	1400	1000			X						X	X	
Hawa Clipo 15 H FS	15	min. 19	1400	1000							X		X	X	
Hawa Clipo 16 H IS	16	16-19	1400	1000	X	X			X				X	X	X
Hawa Clipo 16 H MS	16	16-19	1400	1000	X		X						X	X	X
Hawa Clipo 16 H FS 4-point guidance	16	min. 16	1400	1000	X						X		X	X	X
Hawa Clipo 16 H IS/MS	16	16-19	1400	1000	X				X	X			X	X	X
Hawa Clipo 16 H IS/FS	16	16-19	1400	1000	X				X		X		X	X	X
Hawa Clipo 16 HM IS	16	min. 19	1400	1000	X	X			X				X	X	X
Hawa Clipo 26/36 H IS	26/36	19-25	2200	1000	X	X			X				X	X	X
Hawa Clipo 26 H MS	26	19	2200	1000	X		X				X		X	X	X
Hawa Clipo 36 H MS	36	25	2400	1000	X		X				X		X	X	X
Hawa Clipo 36 HM IS	36	19-25	2400	1000	X	X			X				X	X	X
Hawa Combino	20/35/40/50/65/80	19-40	2800	1600	X	X	X	X	X	X	X		X	X	X
Hawa Combino 20/35 H IS	20/35	19	2200	1200	X	X			X				X	X	X
Hawa Combino 20/35 H MS	20/35	19	2200	1200	X		X						X	X	X
Hawa Combino 20/35 H FS	20/35	19	2200	1200	X			X					X	X	X
Hawa Combino 50 H MS	50	19-25	2400	1400	X		X						X	X	X



On furniture

	Technical specifications					Design/installation							Recommended application		
Wood															
Sliding doors															
Hawa Combino 50 H FS	50	19-25	2400	1400	X			X				X	X	X	
Hawa Combino 65 H IS ol	65	25-40	2600	1400	X	X			X			X	X	X	
Hawa Combino 65 H MS ol	65	25	2600	1400	X		X					X	X	X	
Hawa Combino 65 H FS ul	65	25	2600	1400	X			X				X	X	X	
Hawa Combino 65 H FS ol	65	19-40	2600	1400	X			X				X	X	X	
Hawa Combino 80 H FS ul	80	25/40	2800	1600	X			X				X	X	X	
Hawa Combino 80 H FS ol	80	19-40	2800	1600	X			X				X	X	X	
Hawa Combino L 40	40	19	1500	1500	X			X		X		X	X	X	
Hawa Combino L 40 H FS	40	19	1500	1500	X			X		X		X	X	X	
Hawa Combino L 40 H FS Synchro	40	19	1500	800				X		X		X	X	X	
Hawa Creation (H/G combination)	25	6/19	2200	1200	X				X	X		X	X	X	
Hawa Creation 25 H IS/FS	25	19	2200	1200	X				X	X		X	X	X	
Hawa Creation 25 GAK/H IS/FS	25	6(19)	2000(2100)	1000(1200)	X				X	X		X	X	X	
Hawa Frontal	25	19	2000	800	X			X				X	X	X	
Hawa Frontal 25 H FS	25	19	2000	800	X			X				X	X	X	
Hawa Frontino	20/40	19-25	2400	600-1200	X					X		X	X	X	
Hawa Frontino 20 H FS ul	20	19-25	1000	600-1200	X					X		X	X	X	
Hawa Frontino 20 H FS ol	20	19-25	1000	600-1200	X					X		X	X	X	
Hawa Frontino 20 H OS FS	20	19-25	1000	600-1200	X					X		X	X	X	
Hawa Frontino 40 H FS	40	19	2400	600-1200	X					X		X	X		
Hawa Libra	20	16-30	1000	1600					X	X		X	X	X	
Hawa Libra 20 H IS/FS	20	16-30	1000	1600					X	X		X	X	X	
Hawa Libra 20 H IS/FS Synchro	20	16-30	1000	1600					X	X		X	X	X	
Hawa Miniroll	15/25	19-40	2600	1500		X			X			X	X	X	
Hawa Miniroll 15/25	15/25	19-40	2600	1500		X			X			X	X	X	
Hawa Regal A	25/40	19-50	2500	1200	X					X		X	X	X	
Hawa Regal A 25 H FS	25	19-25	2400	1200						X		X	X	X	
Hawa Regal A 40 H FS	40	19-50	2500	1200	X					X		X	X	X	
Hawa Regal B (H/G combination)	25	16-50	2000	1200	X	X			X	X		X	X		
Hawa Regal B 25 H IS	25	16-50	2000	1200	X	X			X			X	X	X	
Hawa Regal B 25 H FS	25	16-50	2000	1200	X					X		X	X	X	
Hawa Regal B 25 HG FS	25	4-6 (23-25)	1800	1200	X					X		X	X	X	
Hawa Regal B 25 H X FS	25	16-50	2000	1200	X					X					
Hawa Regal C	16/26	16-19	2200	1200	X	X			X	X		X	X	X	
Hawa Regal C 16 H IS/FS	16	4/16	1400	1000	X					X		X	X	X	
Hawa Regal C 16 H IS	16	19	1400	1000	X				X						
Hawa Regal C 16 HM IS	16	19	1400	1000	X				X			X	X	X	
Hawa Regal C 26 HM IS	26	19	2200	1200	X	X			X			X	X	X	
Sliding doors, stackable															
Hawa Aperto	40	19-25	2600	400-900					X		X	X	X	X	
Hawa Aperto 40 F	40	19-25	2600	400-900					X		X	X	X	X	

Sliding on furniture product overview



On furniture

	Technical specifications					Design/installation							Recommended application		
Wood															
Pivot and folding/sliding doors															
Hawa Concepta	25/30/40/50	19-50	1250-2850	300-900	X					X	X	X	X	X	X
Hawa Concepta 25	25	19-50	1250-1850	300-750	X					X	X	X	X	X	X
Hawa Concepta 30	30	19-50	1851-2300	300-900	X					X	X	X	X	X	X
Hawa Concepta 40	40	19-50	1851-2500	300-900	X					X	X	X	X	X	X
Hawa Concepta 50	50	19-50	2301-2850	300-900	X					X	X	X	X	X	X
Hawa Folding Concepta	25	19-26	1250-2600	300-700						X	X	X	X	X	
Hawa Folding Concepta 25	25	19-26	1250-2600	300-700						X	X	X	X	X	
Folding sliding doors															
Hawa Multifold	30	19-25	2600	200-650						X	X	X	X	X	X
Hawa Multifold 30	30	19-25	2600	200-650						X	X	X	X	X	X
Hawa Multifold 30/W	30	19-25	2600	200-500						X	X	X	X	X	X
Pull-outs															
Hawa Forte	170/340	16-40	2400	800	X						X		X	X	X
Hawa Forte 170	170	16-40	2200	600	X						X		X	X	X
Hawa Forte 340	340	16-40	2400	800							X		X	X	X
Hawa Forte 170 DS	170	16-40	2200	600	X						X		X	X	X
Glass															
Sliding doors															
Hawa Clipo	16/26/36	4-8 (12/22)	2000	1000	X	X				X			X	X	X
Hawa Clipo 16 GK IS	16	6-6.35	1400	1000	X	X				X			X	X	X
Hawa Clipo 16 GS IS	16	6-6.35	1400	1000	X	X				X			X	X	X
Hawa Clipo 16 GPK/GPPK IS	16	6-6.35 (12)	1400	1000	X	X				X			X	X	X
Hawa Clipo 26 GR IS	26	4 (20)	2000	800	X	X				X			X	X	X
Hawa Clipo 36 GPK/GPPK IS	36	6-8 (12)	2000	1000	X	X				X			X	X	X
Hawa Clipo 36 GPPK IS fixed glass	36	6-8 (12)	2000	1000	X	X				X			X	X	X
Hawa Clipo 36 G IS	36	6-8 (20-22)	2000	1000	X	X				X			X	X	X
Hawa Frontal	25	4/6 (20/22)	2200	800	X			X					X	X	X
Hawa Frontal 25 GK FS	25	6	2000	800	X			X					X	X	X
Hawa Frontal 25 GR 20/20 FS	25	4 (20)	2000	800	X			X					X	X	X
Hawa Frontal 25 GR 40/22 FS	25	4 (22)	2000	800	X			X					X	X	X
Hawa Regal A	25	4 (22)	2200	1200							X		X	X	X
Hawa Regal A 25 GR FS	25	4 (22)	2200	1200							X		X	X	X
Hawa Regal B	25	4-8	1800	1200	X						X		X	X	X
Hawa Regal B 25 SP FS	25	4-8	1800	1200	X						X		X	X	X
Hawa Regal 25 GK FS	25	4-6	1800	1200	X						X		X	X	X
Hawa Regal 25 X FS	25	4-8	1800	1200	X						X		X	X	X
Hawa Regal C	16/26	4-6.35 (12/20)	2000	1000	X	X					X		X	X	X
Hawa Regal C 16 GPPK IS	16	6-6.35 (12)	1400	1000	X					X			X	X	X
Hawa Regal C 26 GR IS	26	4 (20)	2000	800	X	X					X		X	X	X

Glass recommendations on furniture

	Float glass	ESG Fully tempered monolithic safety glass	VSG (from float glass) Laminated glass made from float glass	VSG (from ESG) Laminated glass made from tempered safety glass	VSG (from TVG) Laminated glass made from heat-strengthened glass
On furniture					
Hawa Clipo 16 GPK IS Hawa Clipo 16 GPPK IS Hawa Clipo 26 GR IS Hawa Clipo 36 G IS Hawa Clipo 36 GPK IS Hawa Clipo 36 GPPK IS Hawa Clipo 36 GPPK IS Fixed glass	[O]	●			
Hawa Clipo 16 GS IS Hawa Clipo 16 GK IS		●	[O]		

● Recommended by Hawa Sliding Solutions

[O] With restrictions (float glass due to breaking resistance/laminated glass made from float glass due to appearance of glass edges)

□ Application not recommended for aesthetic reasons, since misalignment of up to 4 mm may occur due to technical reasons during production.

Float

Float glass is conventional structural glass that is manufactured using the so-called float process (floating a on a bath of molten tin).

ESG

Fully tempered monolithic safety Glass with a minimum surfacae compression of 15'000 psi. (DIN EN 12150-1). It is manufactured using special heat treatment. When the glass breaks, tempered safety glass shatters into small blunt-edged fragments. Tempered safety glass has extremely good resilience to breakage, bending resistance, impact resistance and thermal shock resistance.

VSG

Laminated glass (DIN EN 14449) is produced by bonding two or more of glass together by means of one or more extremely flexible polyvinyl butyral (PVB) interlayers (0.38–max. 0.76 mm). When laminated glass breaks, the fragments adhere to the interlayer.

TVG

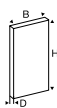
Heat-strengthened glass is thermally treated float glass and has a breakage pattern similar to glass that has not been thermally treated. It is more resistant to stress and impact than untreated glass.

Technical information

General information

- Products have been tested in accordance EN 15706 and EN 15570)
- Maximum door weights and door dimensions see respective catalog pages. The maximum door weight may not be exceeded!
- The products are inapplicable for outdoor applications/use.
- With high gloss lacquered doors use material that is at least 20 mm thick, in order to avoid damaging the finish with the screws
- The length dimensions of the standard profiles from the Hawa range are subject to DIN ISO 2768-1 c (+/- 4 mm)
- Subject to technical modifications. No liability assumed.

Door weight calculation Hawa Combino/Hawa Clipo



	Chipboard				MDF			Glass			
Door weights											
D mm	16	19	22	25	16	19	25	4	6	8	
B × H											
500 × 1200	6.6	7.8	8.7	9.9	7.5	8.7	11.4	6.0	9.0	12.0	
500 × 1800	9.9	11.7	13.1	14.9	11.3	13.1	17.1	9.0	13.5	18.0	
600 × 1800	11.9	14.0	15.7	17.8	13.5	15.7	20.6	10.8	16.0	21.6	
600 × 2200	14.5	17.2	19.1	21.8	16.5	19.2	25.1	13.2	19.8	26.4	
600 × 2400	15.8	18.7	20.9	23.8	18.0	20.9	27.4	14.4	21.6	28.8	
800 × 1800	15.8	18.7	20.9	23.8	18.0	20.9	27.4	14.4	21.6	28.8	
800 × 2200	19.4	22.9	25.5	29.0	22.0	25.6	33.5	17.6	26.4	35.2	
800 × 2400	21.1	25.0	27.8	31.7	24.0	27.9	36.5	19.2	28.8	38.4	
1000 × 1200	13.2	15.6	17.4	19.8	15.0	17.4	22.8	12.0	18.0	24.0	
1000 × 2400	26.4	31.2	34.8	39.6	30.0	34.8	45.6	24.0	36.0	48.0	
kg/m ²	11.0	13.0	14.5	16.5	12.5	14.5	19.0	10.0	15.0	20.0	

Planning/execution Hawa Concepta family

For planning and execution, use the planning tools at www.planningconcepta.hawa.com



Protection of trademarks/Copyright

HAWA is a trademark registered in the name of Hawa Sliding Solutions AG. The names Junior, Concepta, Clipo and Frontino are product family names either registered in the name of Hawa Sliding Solutions AG, or to which Hawa Sliding Solutions AG claims exclusive rights of use in connection with its products and services. The contents of this publication, including all photographs and graphics are protected by copyright, and may not be copied, modified or otherwise used without the explicit consent of Hawa Sliding Solutions AG.

General Terms and Conditions

Conditions of sale, delivery and payment are subject to the General Terms and Conditions of Hawa Sliding Solutions AG, which are available at www.hawa.com.

Wherever you are – we are there for you

Our integrated sales and service area is the right contact for inquiries concerning our solutions, products and systems. We look forward to you contacting us by e-mail or telephone.

Contact

info@hawa.com, Tel. +41 44 787 17 17

Hawa Sliding Solutions AG

Factory Mettmenstetten (headquarters)
Untere Fischbachstrasse 4
8932 Mettmenstetten, Switzerland

Hawa Sliding Solutions AG

Factory Sirnach
Wilerstrasse 90
8370 Sirnach, Switzerland

We would be pleased to support you worldwide:

North America

Our North American subsidiary is in Dallas, Texas, and looks after sales and technical partners in the USA and Canada.

Hawa Group Americas Inc.

150 Turtle Creek Blvd, Ste 209A
Dallas, TX 75207, United States of America
Tel. +1 214 760 9054, Fax +1 214 760 8627

Asia and the Pacific

Our latest subsidiary is in Singapore. We have been looking after sales and specialist partners in the South East Asia, Australia and Pacific Basin areas since 2017.

Hawa Sliding Solutions APAC Pte. Ltd

123 Penang Road, #06-13 Regency House
238465 Singapore, Singapore
Tel. +65 6887 4900

Middle East

Our subsidiary in Dubai has been advising and supporting our sales and specialist partners on the Arabian peninsula since 2005. In addition to the United Arab Emirates, we also look after partners in Saudi Arabia, Bahrain, Oman and other surrounding countries from here.
















Hawa Middle East FZE

Office #608, 6th Floor, Jafza 16, Jebel Ali Free Zone Dubai, United Arab Emirates
Tel. +971 4 887 3694, Fax +971 4 887 3693

The right sliding solution for every need and every idea

Our overall product range for sliding solutions on buildings, in buildings and on furniture covers all requirements in all areas of application, movement types and sliding versions.


















This overall product range will undergo continuous further development. Hawa Sliding Solutions also provides individual, made-to-measure solutions. Special solutions such as this are developed in close collaboration with our partners and customers. Perhaps together with you?

On buildings 	Technical specifications							Design/installation					Exterior application	
														
Sliding shutters														
Hawa Frontslide	60/100/140	28-60	3200	min. 400				X	X	X	X		X	
Hawa Frontslide Matic	60/100/140	45/50/60	3200		6.24	7500	14.7	X	X	X	X		X	
Folding sliding shutters														
Hawa Frontfold	30	28-36	3200	200-600		12 000	38.4	X					X	X
Hawa Fronttego	30	28-32	700-3200	300-600	1.92	3.6 m	2x12	X					X	X
Special solution, stackable														
Hawa Aperto	60	35-50	2600	550-950	2.47	min. 550	min. 1	X					X	
Windows														
Hawa Vertical	150	85	1200	3200*					X				X	X

* With a height of 1,200 mm, the width is limited to 2,000 mm because of the pulley

** With a width of 3,200 mm, the height is limited to 900 mm because of the pulley

In buildings

		Technical specifications						Installation						Recommended application			Exterior application	
																		
Wood																		
Sliding doors																		
Hawa Junior	40/80/100/120/160/250	35-80	4000	3000		40/80/120	X	X	X	X		X	X	X	X			
Hawa Media	70	35-80	4000	3000			X	X		X			X	X				
Hawa Ordena	70	30-40	2600	3000				X	X	X			X	X				
Hawa Porta	40/45/60/100/300/600	18-100	6000	5000		40/60/100	X	X	X	X			X	X	X			
Hawa Silenta	150	35-80	4000	3000				X	X	X			X	X				
Hawa Super	500	45-100	6000	5000			X	X		X			X	X	X			
Hawa Suono	100	min. 51	2700	700	1340	X	X			X			X	X	X			
Sliding walls																		
Hawa Aperto	60	35-50	2600	550-1500	13600			X		X		X	X	X	X	X	X	X
Hawa Junior	80	32-80	4000	500-1200	6750			X		X		X	X	X	X			
Hawa Divido	100	28-30	2400	1200	6000	X	X	X	X	X	X		X	X	X			
Hawa Variotec	150	36-68	4000	700-1500	12000			X		X		X	X	X	X			
Folding sliding walls																		
Hawa 20 c Folding wall	120	42-80	4000	1000	7000			X		X		X	X	X	X			
Hawa Centerfold	80	35-45 (57)	4000	500-900	6000			X	X	X		X	X	X	X			
Hawa Variofold	80	35-45 (57)	4000	500-900	6310			X	X	X		X	X	X	X			
Transport systems																		
Hawa Varioflex	40	35-80	4000	900				X		X				X				
Glass																		
Sliding doors																		
Hawa Junior	40/80/100/120/160/250	8-16	4000	3000		40/80/120	X	X	X	X			X	X	X			
Hawa Ordena	70	8-10.7	2600	600-3000				X	X	X			X	X	X			
Hawa Porta	40/100	6-12.7	2700	1600		40/60/100	X	X	X	X			X	X	X			
Hawa Puro	150	8-12.7	3000	750-3000				X	X	X			X	X	X			
Hawa Purolino Plus	80	8-12.7	3000	600-3000		X	X	X	X	X			X	X	X			
Hawa Super	250	8-80	4000	3000			X	X		X				X	X			
Sliding walls																		
Hawa Aperto	60	8-10 (30)	2600	500-1100	10900			X		X		X	X	X	X	X	X	X
Hawa Divido	100	5.9-10 (30)	2750	1200	6000	X	X	X	X	X	X		X	X	X			
Hawa Shopfront	400	8-16 (50)	3500	3000	12000			X		X				X	X	X	X	
Hawa Variotec	150	10-13 (36)	3500	700-1500				X		X		X		X	X	X	X	
Folding sliding walls																		
Hawa Centerfold	80	10-13 (36)	2600	500-900	6000			X	X	X		X		X	X	X	X	
Hawa Variofold	80	10-13 (36)	2600	400-900	6310			X	X	X				X	X	X	X	
Hawa Junior	80	8-16 (26)	3000	500-1200	3700			X		X		X	X	X	X			
Shower																		
Hawa Banio	40	8-9	2200	800	1500	X	X			X			X	X	X			



On furniture

	Technical specifications					Design/installation							Recommended application		
Wood															
Sliding doors															
Hawa 220 Planfront	70	19-45	2600	400-1500					X		X	X	X	X	X
Hawa Aperto	40	19-25	2600	400-900					X				X	X	X
Hawa Clipo	15/16/26/36	10-25	2400	1200	X	X	X	X	X		X		X	X	X
Hawa Combino	20/35/40/50/65/80	19-40	2800	1600	X	X	X	X			X		X	X	X
Hawa Creation	25	6/19	2200	1200	X	X		X					X	X	X
Hawa Frontal	25	19	2000	800	X			X					X	X	X
Hawa Frontino	20/40	19-25	2400	600-1200	X						X		X	X	X
Hawa Libra	20	16-30	1000	1600					X		X		X	X	X
Hawa Miniroll	15/25	19-40	2600	1500		X							X	X	X
Hawa Regal A	25/40	19-50	2500	1200	X						X		X	X	X
Hawa Regal B	25	16-50	2000	1200	X	X			X		X		X	X	X
Hawa Regal C	16/26	16-19	2200	1200	X	X			X		X		X	X	X
Pivot and folding/sliding doors															
Hawa Concepta	25/30/40/50	19-50	1250-2850	300-900	X				X	X	X	X	X	X	X
Hawa Folding Concepta	25	19-26	1250-2600	300-700					X	X	X	X	X	X	
Folding sliding doors															
Hawa Multifold	30	19-25	2600	200-650					X	X	X		X	X	X
Pull-outs															
Hawa Forte	170/340	16-40	2400	800	X						X		X	X	X
Glass															
Sliding doors															
Hawa Clipo	16/26/36	4-8 (12/20)	2000	1000	X	X			X				X	X	X
Hawa Frontal	25	4/6 (20/22)	2200	800	X			X					X	X	X
Hawa Regal A	25	4 (22)	2200	1200							X		X	X	X
Hawa Regal B	25	4-8	1800	1200	X						X		X	X	X
Hawa Regal C	16/26	4-6.35 (12/20)	2000	1000	X	X					X		X	X	X

Index icons

Area of application



On buildings



In buildings



On furniture

Technical specifications



Weight



Thickness



Height



Width



Soft closing mechanism



Max. area per door



Max. system width



Max. area



Max. opening width

Design



IS Inslide



MS Mixslide



FS Forslide



IS Inslide
Flush-fitting/
on one level



MS Mixslide
Flush-fitting/
on one level



FS Forslide
Flush-fitting/
on one level

Installation



Fully opening



Half opening



Wall mounting



Ceiling mounting



Ceiling mounting
recessed



ol
Top-running



ul
Bottom-running



Load
Light load
Private
access



Load
Medium load
Semi-public
access



Load
High load
Public
access



Inland
More than 20 km
from the coast



Coastal area
Less than 20 km
from the coast



Hawa Sliding Solutions AG

Untere Fischbachstrasse 4, 8932 Mettmenstetten, Switzerland

Phone +41 44 787 17 17, info@hawa.com, www.hawa.com